



US00D412709S

United States Patent [19]

Lohrding et al.

[11] Patent Number: Des. 412,709

[45] Date of Patent: ** Aug. 10, 1999

[54] **RADIOTELEPHONE ANTENNA**

[75] Inventors: **Bradley K. Lohrding**, Gurnee; **Galina Treyer**, Northbrook; **Mark F. Witzak**, Oakwood Hills, all of Ill.

[73] Assignee: **Motorola, Inc.**, Schaumburg, Ill.

[**] Term: **14 Years**

[21] Appl. No.: **29/088,188**

[22] Filed: **May 18, 1998**

[51] **LOC (6) Cl.** **14-03**

[52] **U.S. Cl.** **D14/234**

[58] **Field of Search** D14/230-238,
D14/240, 137, 138, 142; 343/702, 713,
715

[56] **References Cited**

U.S. PATENT DOCUMENTS

D. 357,683	4/1995	Cline et al.	D14/234
D. 367,655	3/1996	Rak	D14/234
5,559,522	9/1996	Seiz	343/702
5,576,720	11/1996	Gorenz, Jr. et al.	343/702

Primary Examiner—Louis S. Zarfes

Assistant Examiner—G. Andoll

Attorney, Agent, or Firm—John J. Oskorep; Lalita P. Williams

[57] **CLAIM**

The ornamental design for a radiotelephone antenna, as shown and described.

DESCRIPTION

FIG. 1 is a front, bottom, and left side perspective view showing my new design for a radiotelephone antenna;

FIG. 2 is a bottom plan view thereof;

FIG. 3 is a right side elevational view thereof;

FIG. 4 is a front elevational view thereof;

FIG. 5 is a left side elevational view thereof;

FIG. 6 is a rear elevational view thereof; and

FIG. 7 is a top plan view thereof.

FIG. 8 is a front, bottom, and left side perspective view showing of our new design for a radiotelephone antenna in an alternate position;

FIG. 9 is a right side elevational view thereof;

FIG. 10 is a front elevational view thereof;

FIG. 11 is a left side elevational view thereof;

FIG. 12 is a rear elevational view thereof;

FIG. 13 is a bottom plan view thereof; and,

FIG. 14 is a top plan view thereof.

The broken line matter in the drawings is for illustrative purposes only and forms no part of the claimed design.

1 Claim, 6 Drawing Sheets

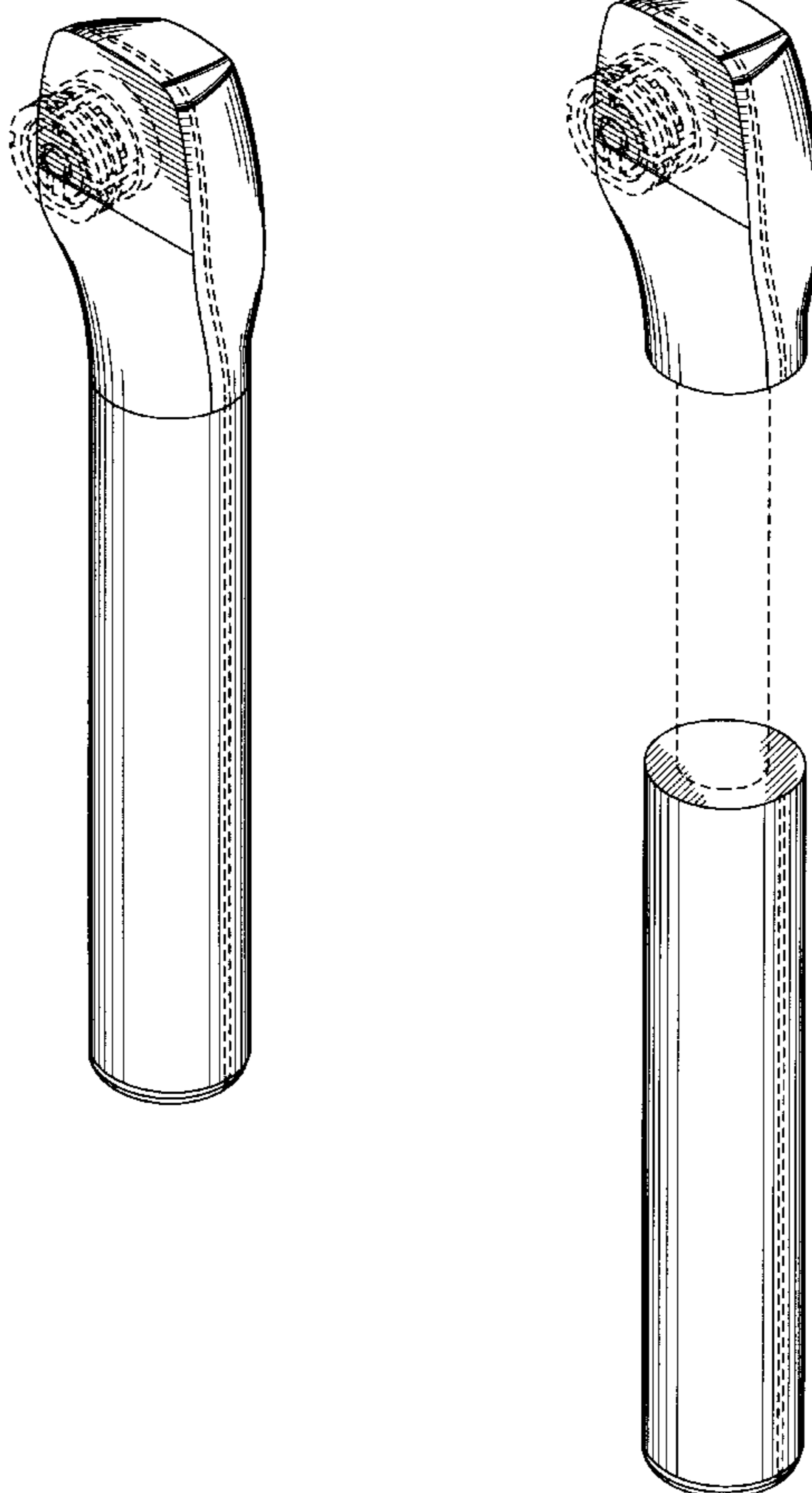

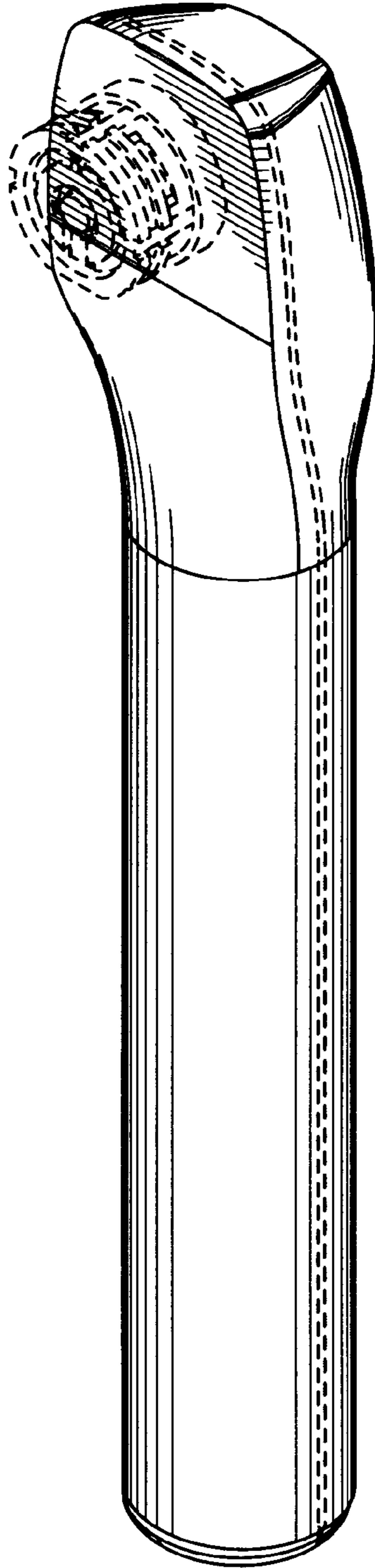

FIG. 1

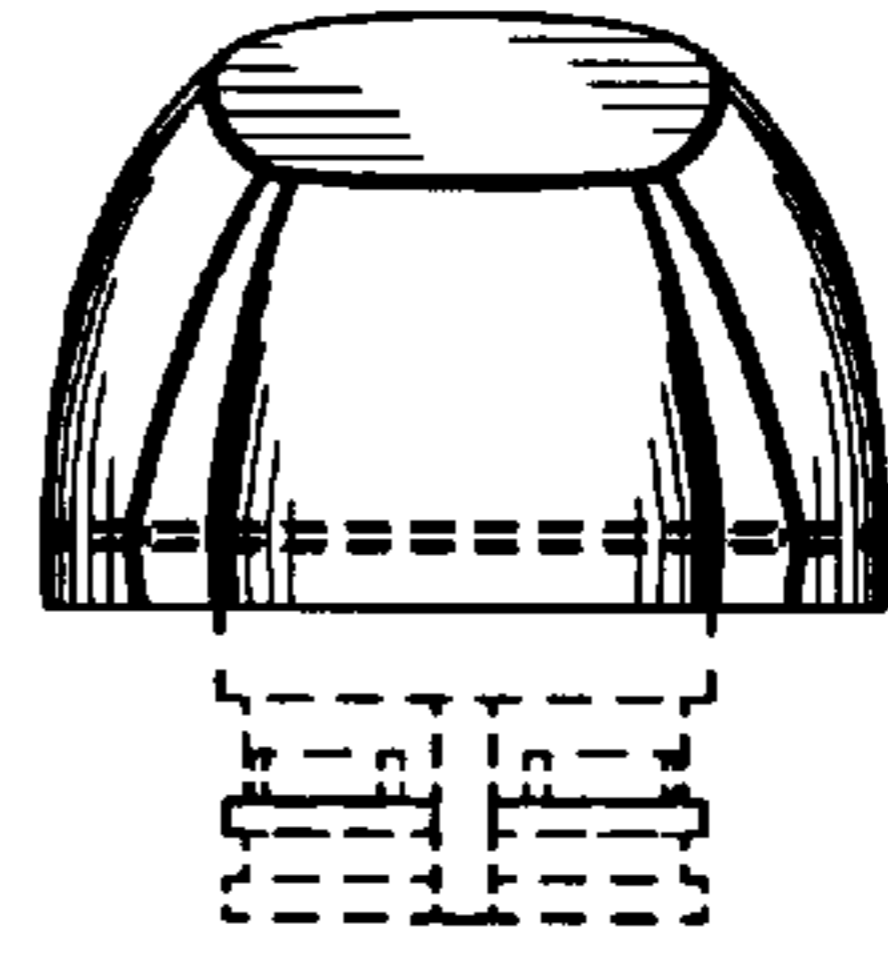

FIG. 2

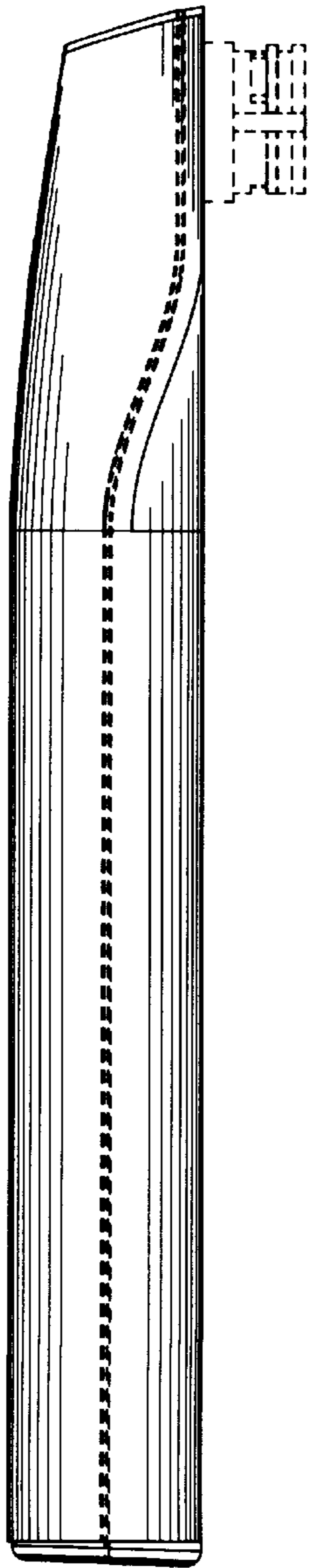

FIG. 3

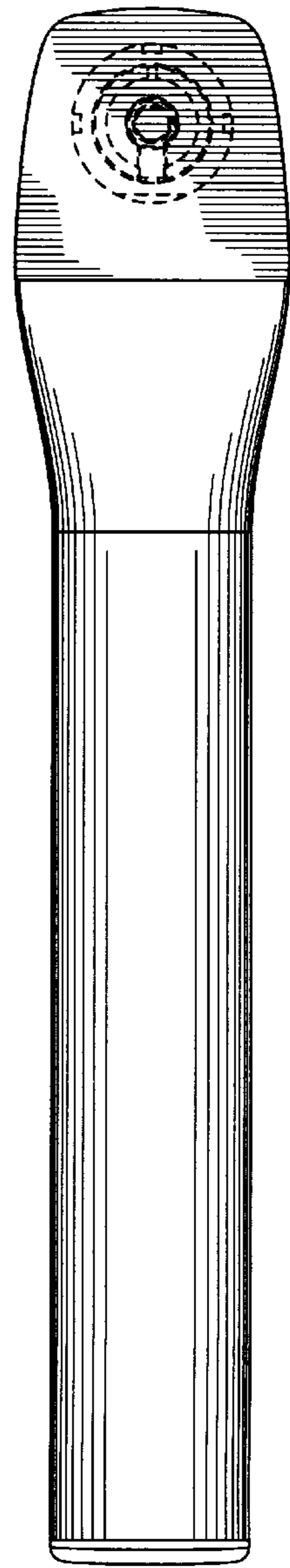

FIG. 4

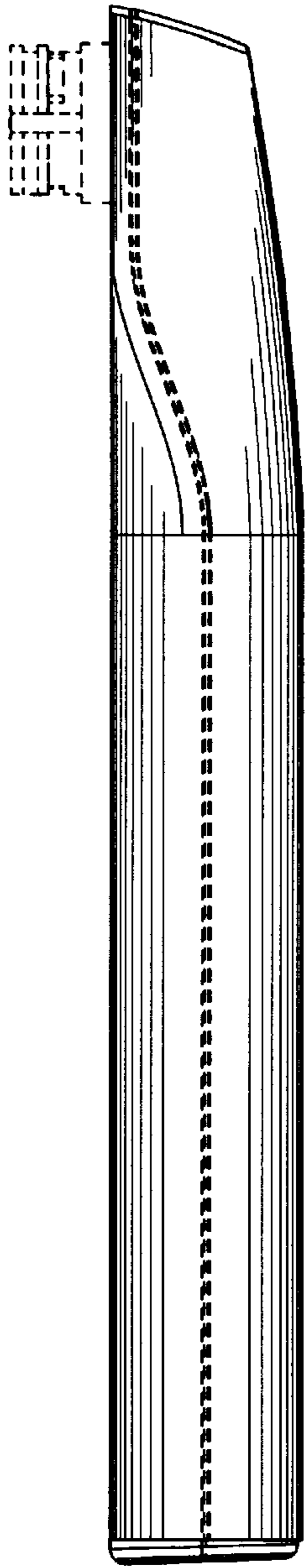

FIG. 5

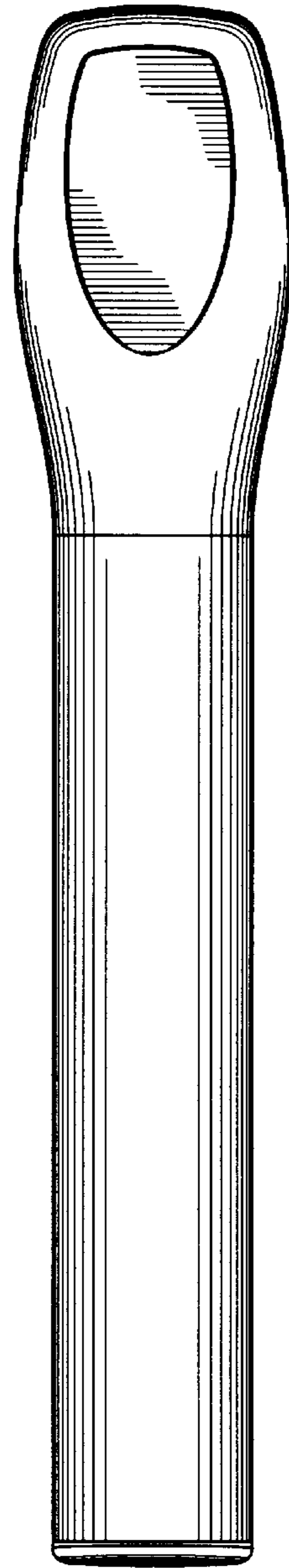

FIG. 6

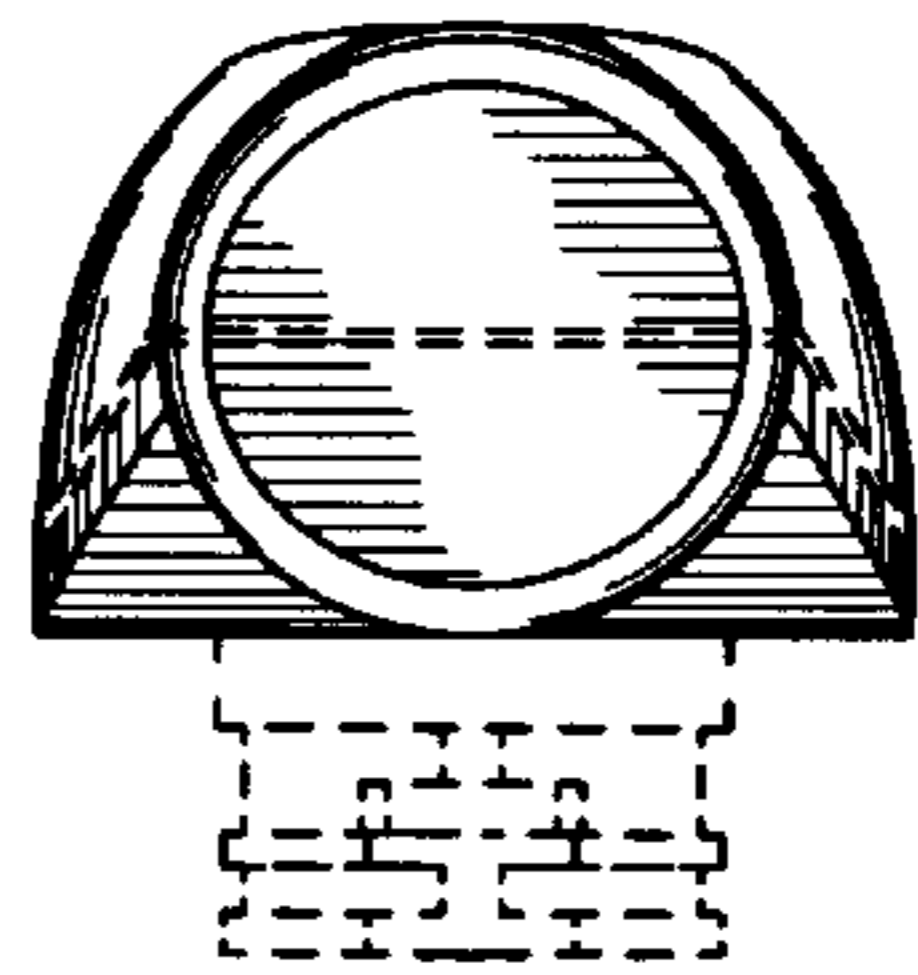

FIG. 7

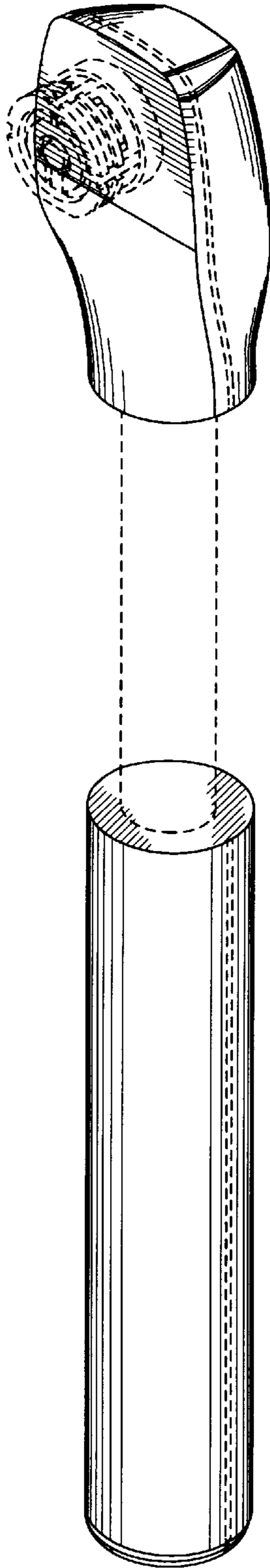

FIG. 8

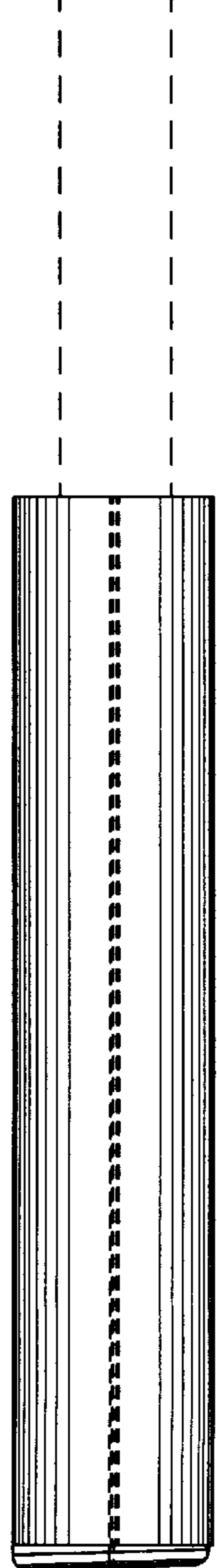
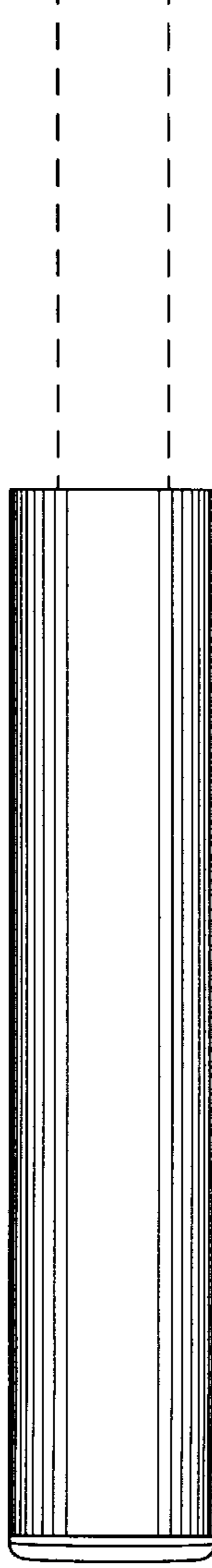
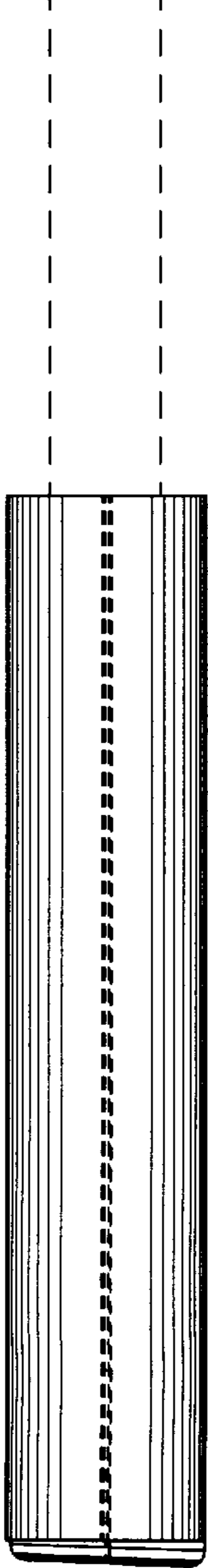
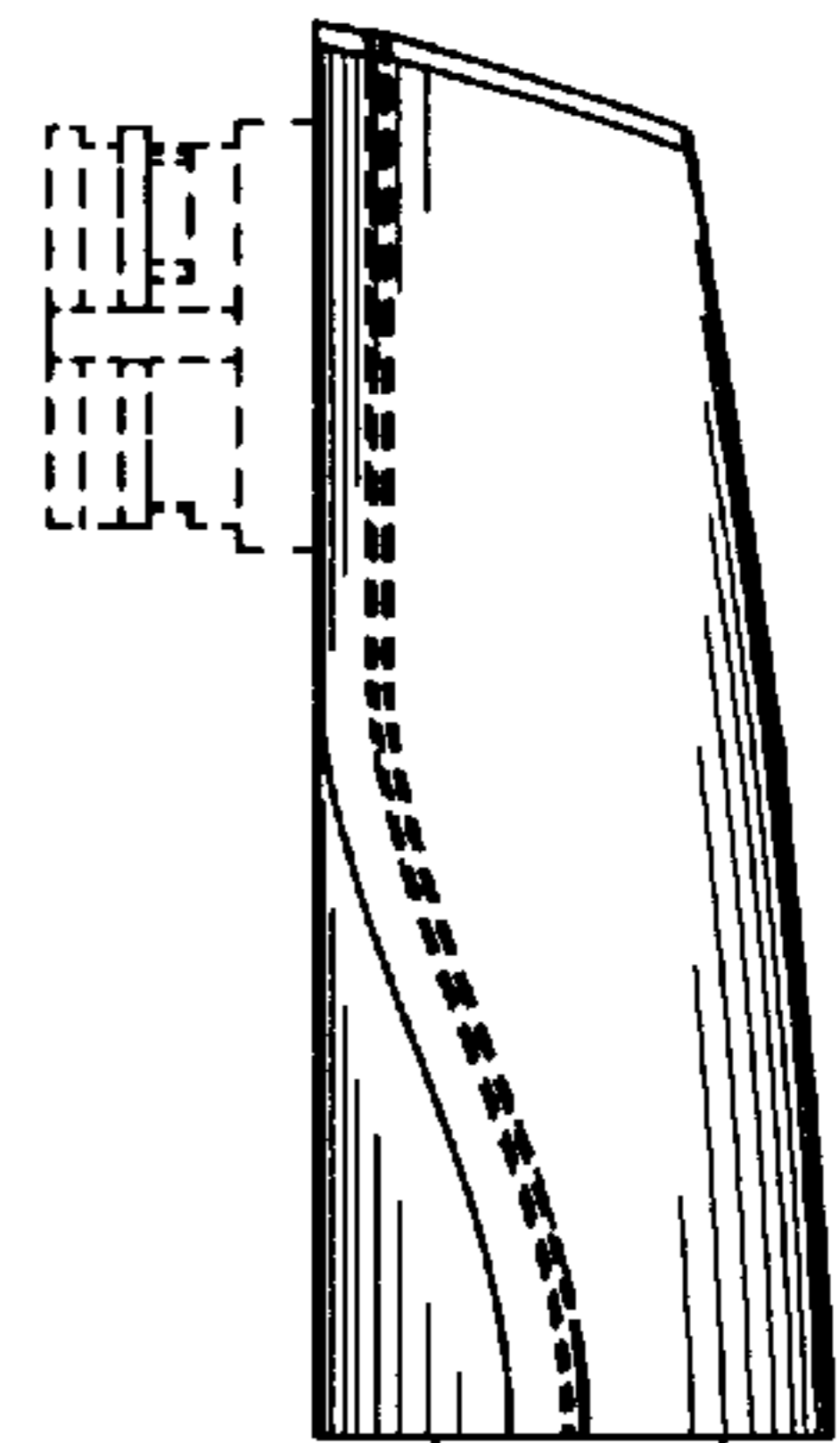
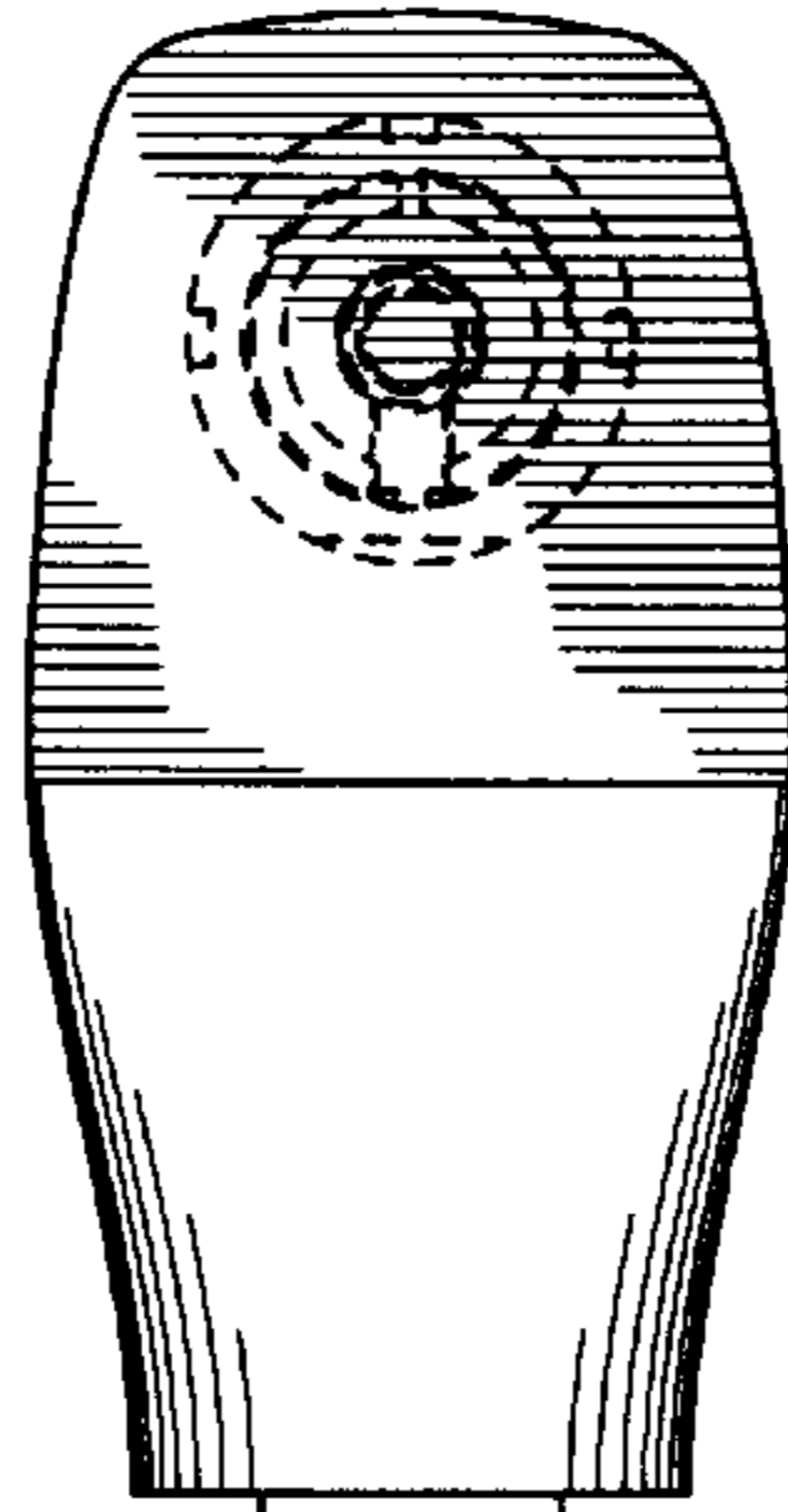
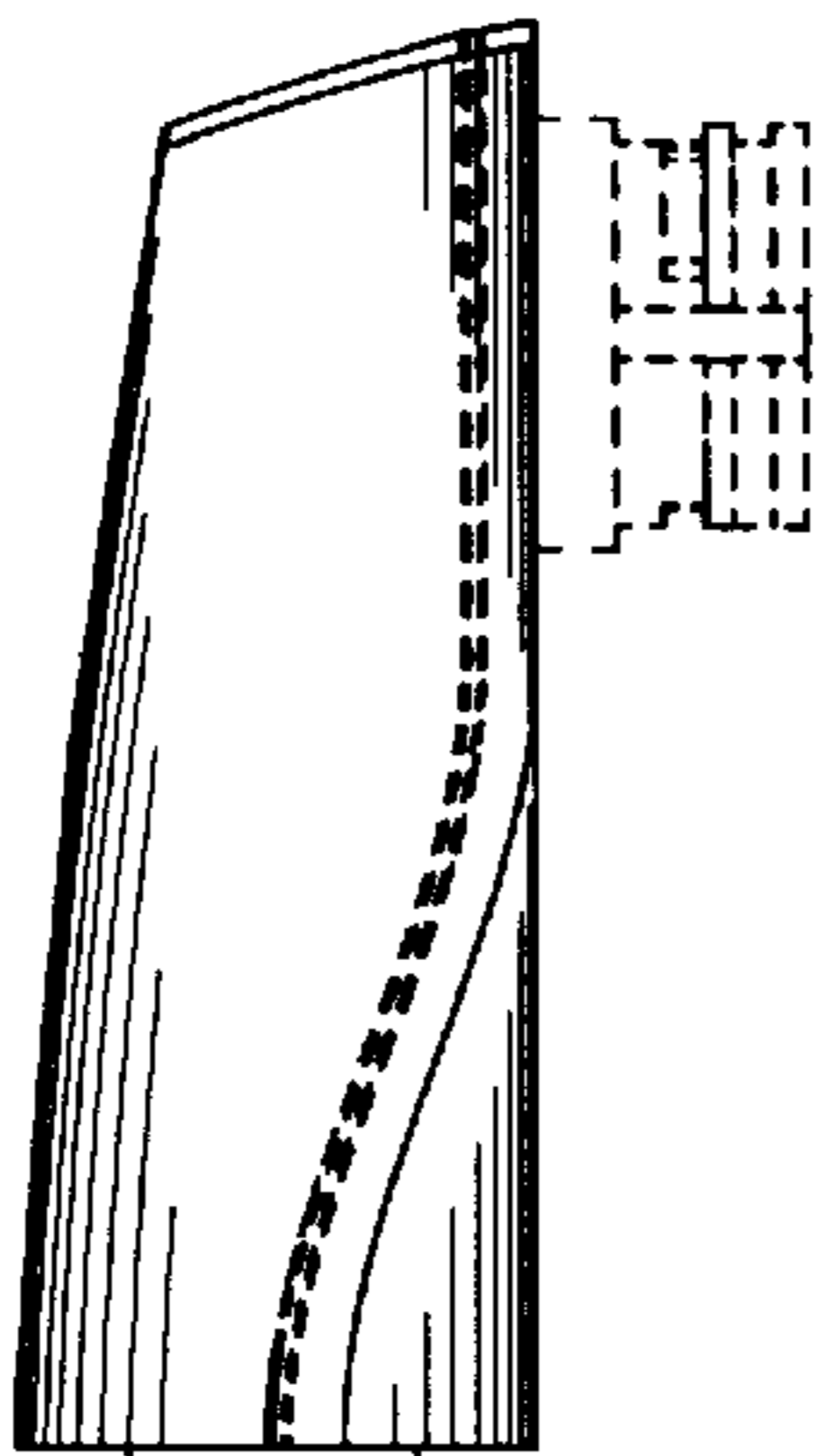

FIG. 9

FIG. 10

FIG. 11

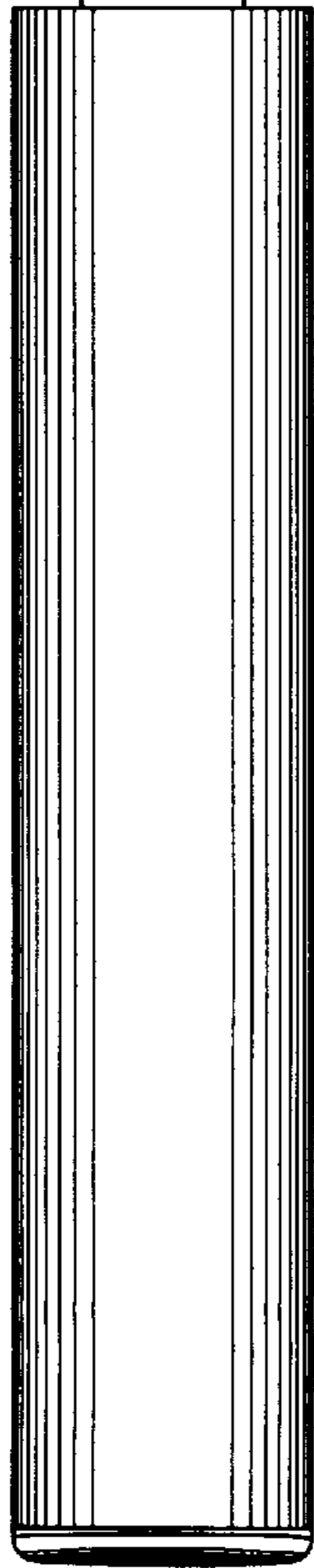
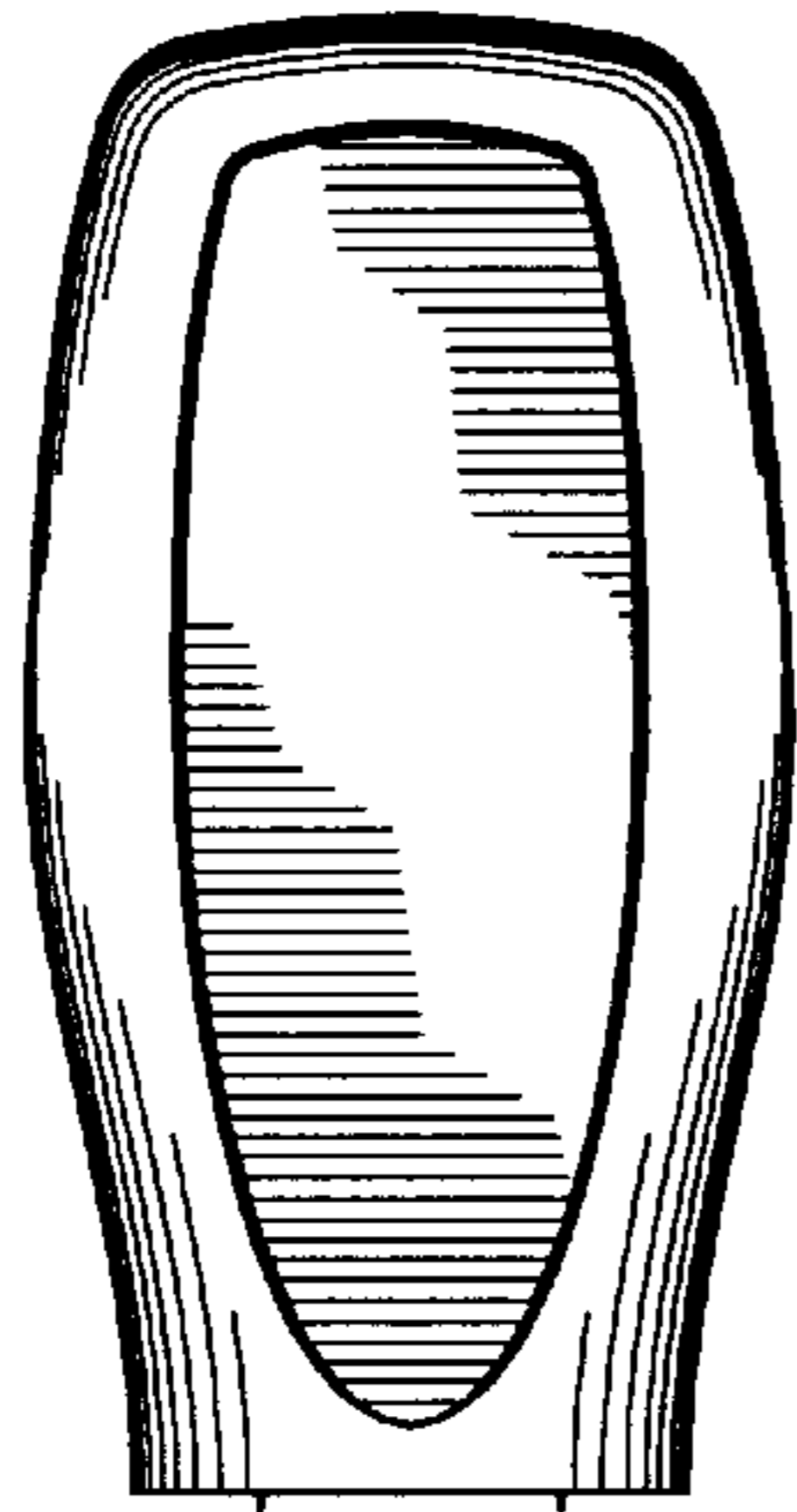

FIG. 12

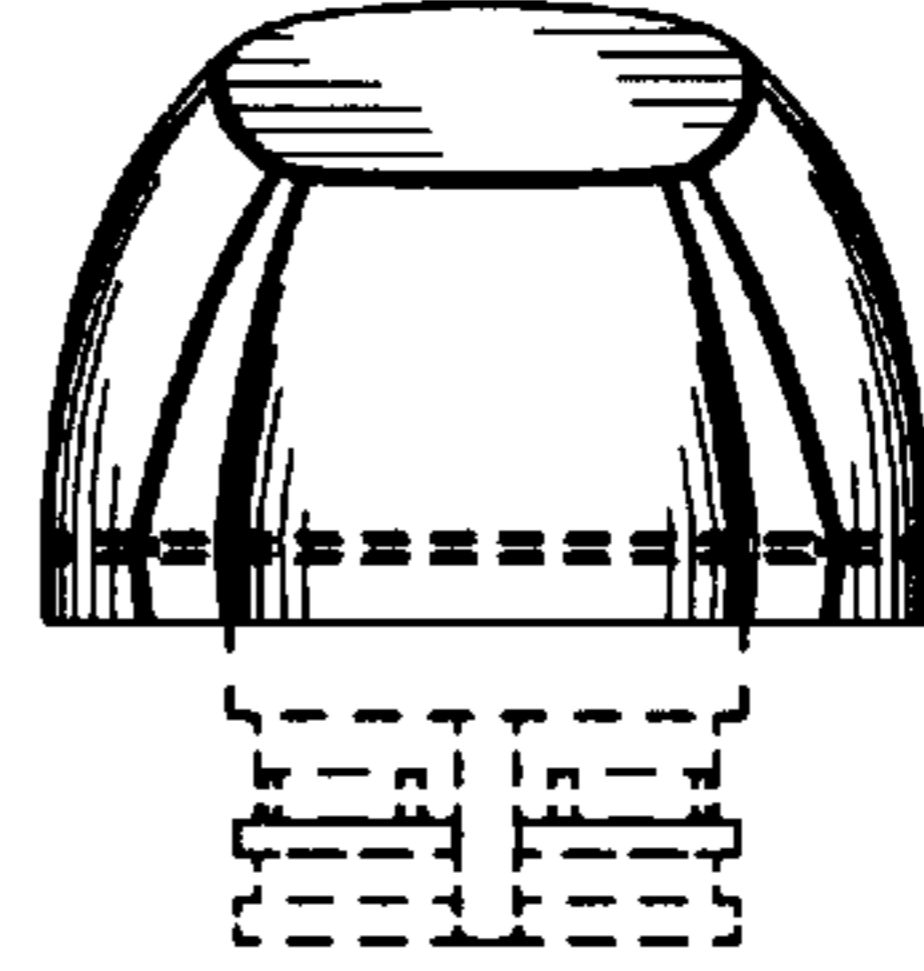

FIG. 13

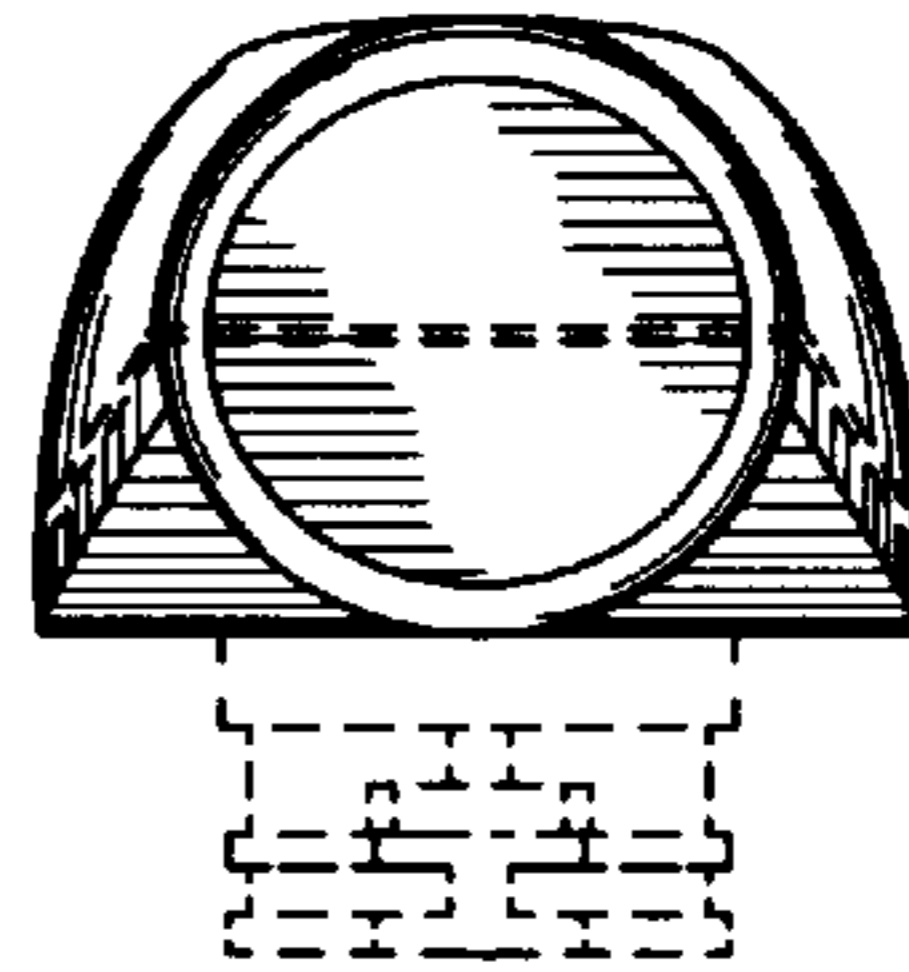

FIG. 14