



US00D412637S

United States Patent [19] Piret

[11] **Patent Number: Des. 412,637**

[45] **Date of Patent: ** Aug. 10, 1999**

[54] **ELECTRIC OVEN**

[75] Inventor: **Philippe Piret**, Benouville, France

[73] Assignee: **Robert Krups GmbH & Co.KG**, Solingen, Germany

[**] Term: **14 Years**

[21] Appl. No.: **29/079,679**

[22] Filed: **Nov. 20, 1997**

[30] **Foreign Application Priority Data**

May 20, 1997 [FR] France 97 2967

[51] **LOC (6) Cl. 07-02**

[52] **U.S. Cl. D7/350**

[58] **Field of Search** D7/350, 351; 126/275 R, 126/275 E, 19 M, 21 A; 219/10.55 R, 10.55 A, 10.55 B, 10.55 C

[56] **References Cited**

U.S. PATENT DOCUMENTS

- D. 301,428 6/1989 Viancin D7/350
- D. 304,411 11/1989 Yoo D7/351
- D. 318,396 7/1991 Jung D7/351

- D. 329,779 9/1992 Piret D7/351
- D. 336,814 6/1993 Brookshire D7/350
- D. 381,861 8/1997 Rorke et al. D7/350
- D. 386,938 12/1997 Piret D7/350

OTHER PUBLICATIONS

Woodward & Lothrop catalog, May 4, 1986, p. 20. "Afredo toaster oven", top of page.

Primary Examiner—Ruth McInroy
Attorney, Agent, or Firm—Darby & Darby

[57] **CLAIM**

We claim the ornamental design for an electric oven, as shown.

DESCRIPTION

FIG. 1 is a top, front, and left side perspective view of an electric oven showing our new design; FIG. 2 is a front elevation view thereof; FIG. 3 is a right side elevation view thereof; FIG. 4 is a rear elevation view thereof; FIG. 5 is a left side elevation view thereof; FIG. 6 is a top plan view thereof; and, FIG. 7 is a bottom plan view thereof.

1 Claim, 5 Drawing Sheets

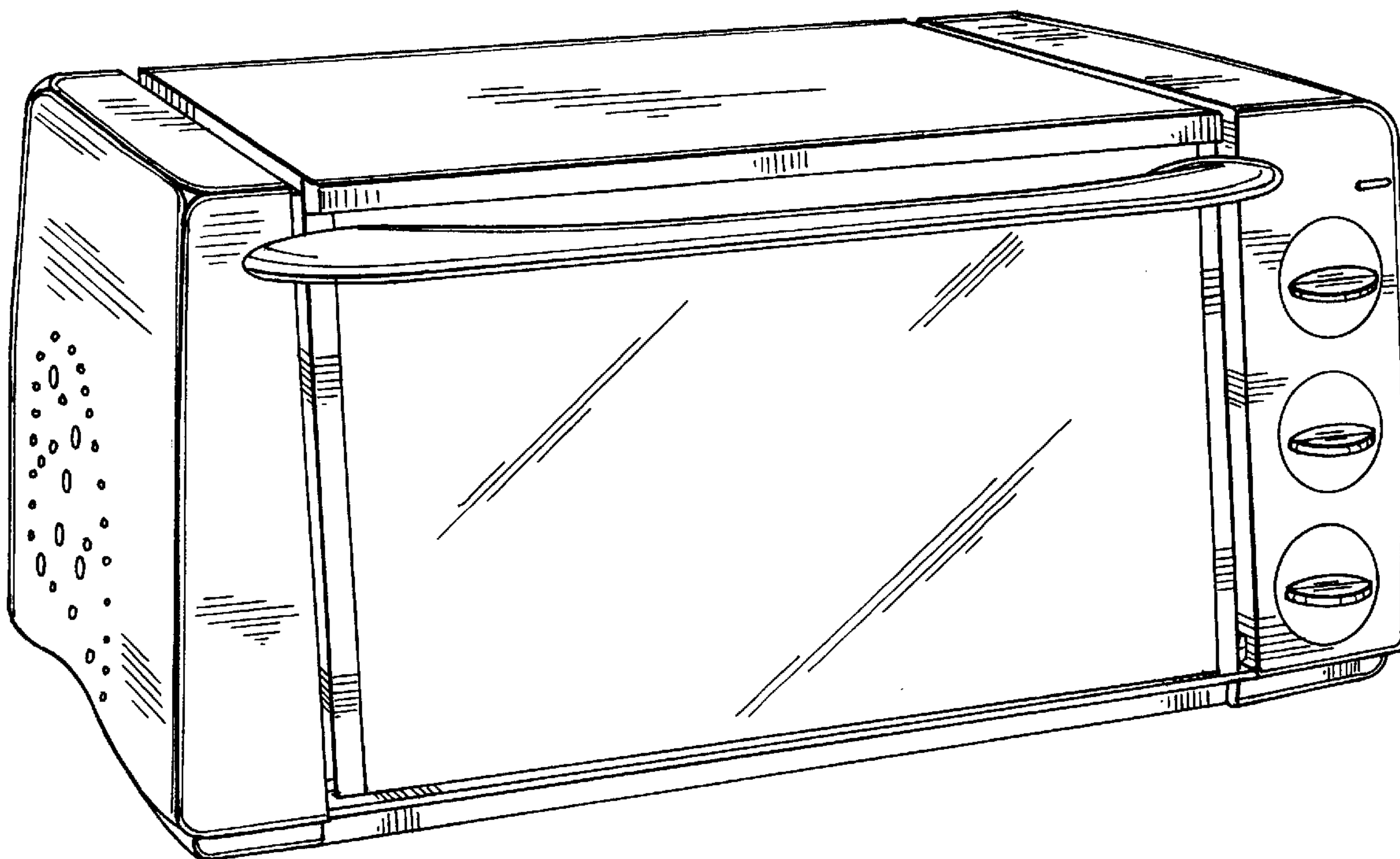

FIG. 1

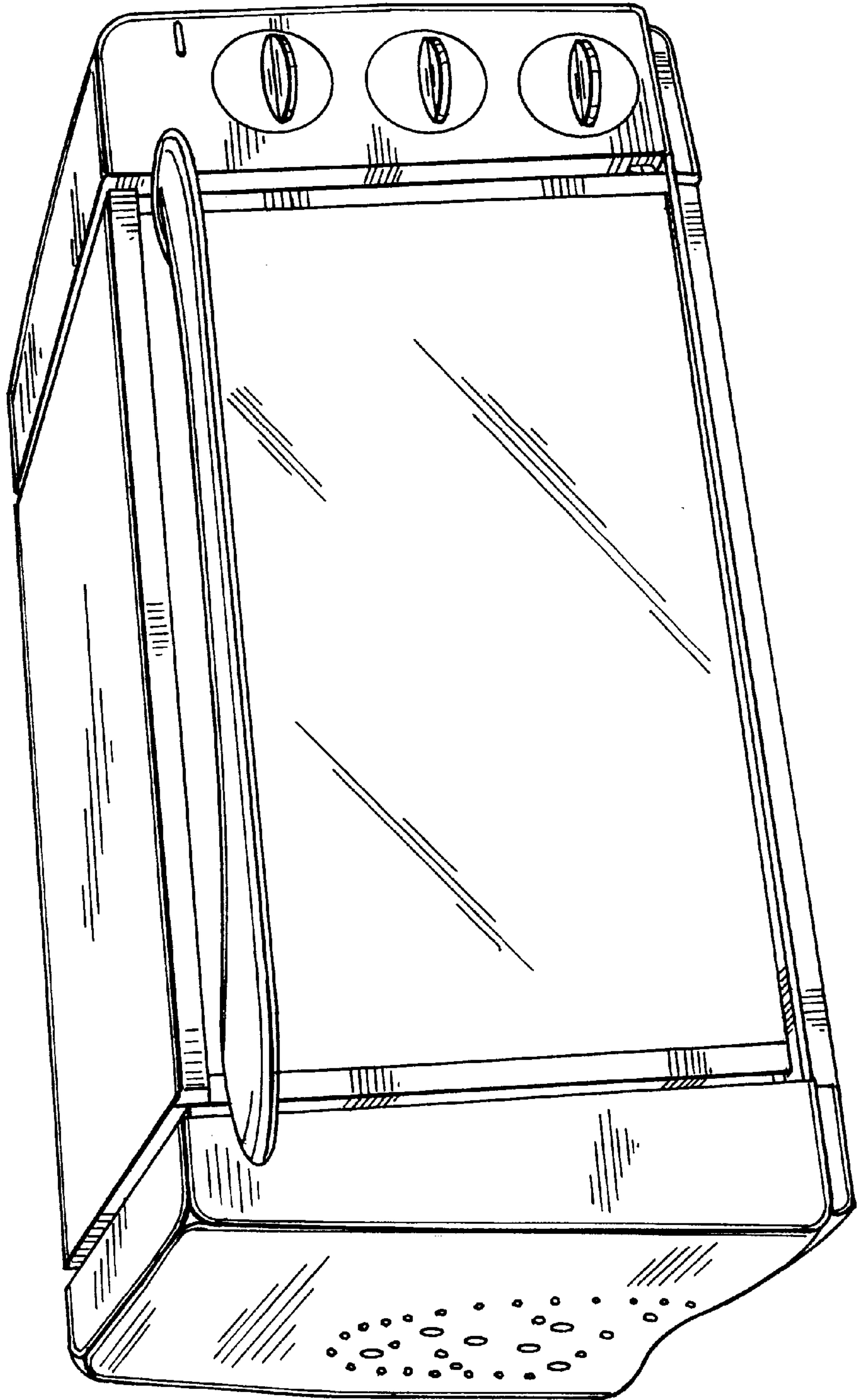

FIG. 2

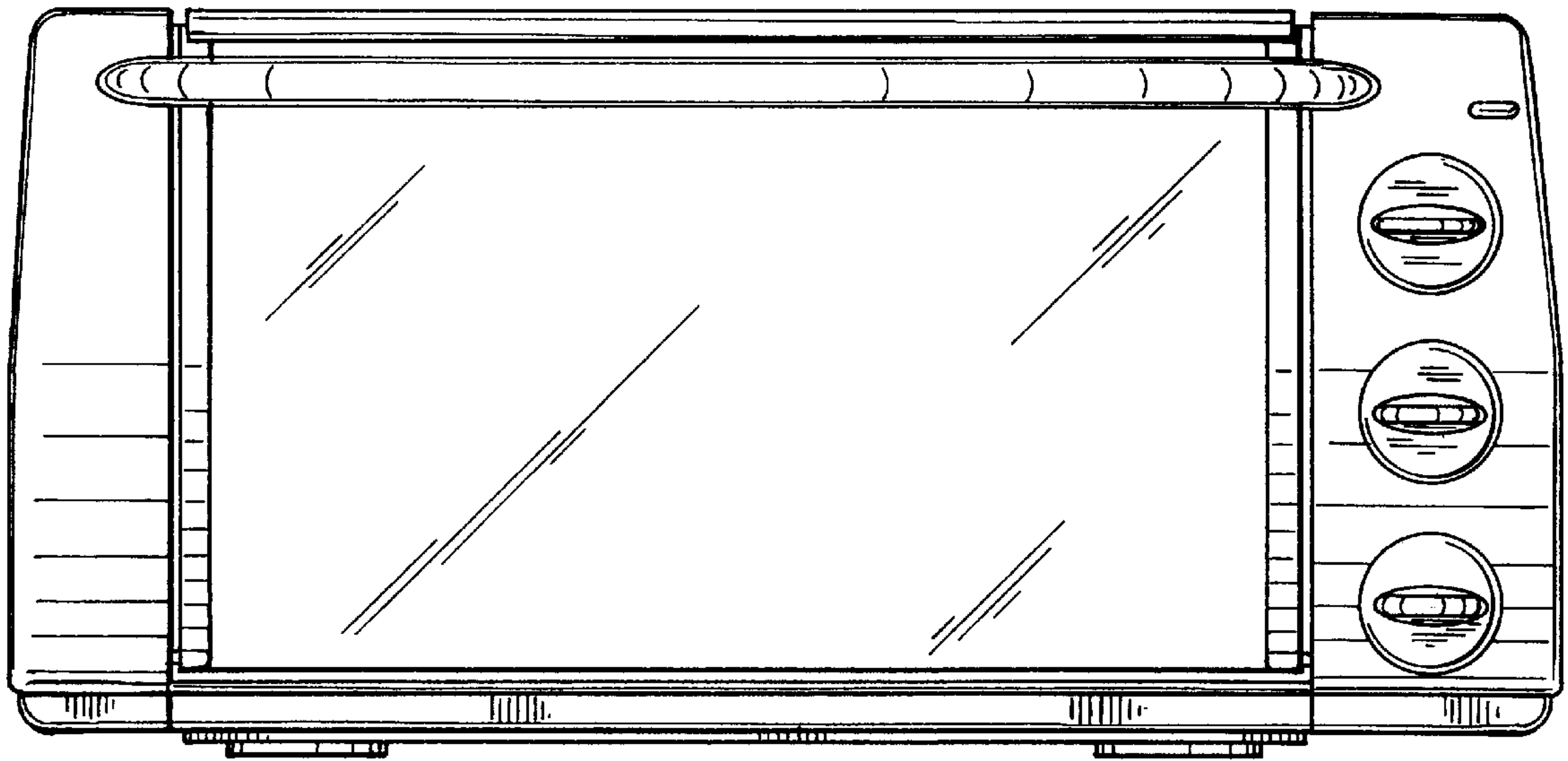

FIG. 3

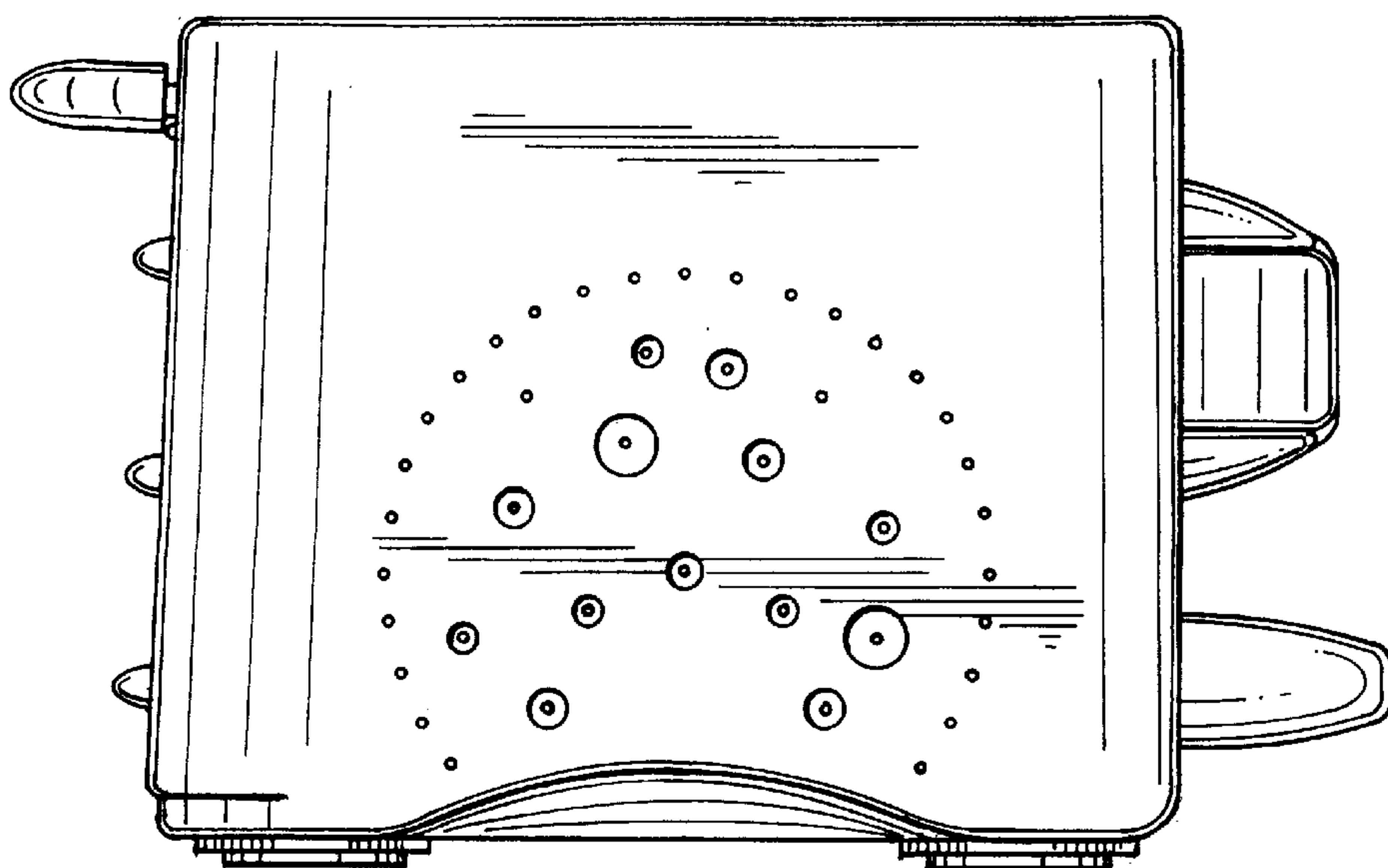

FIG. 4

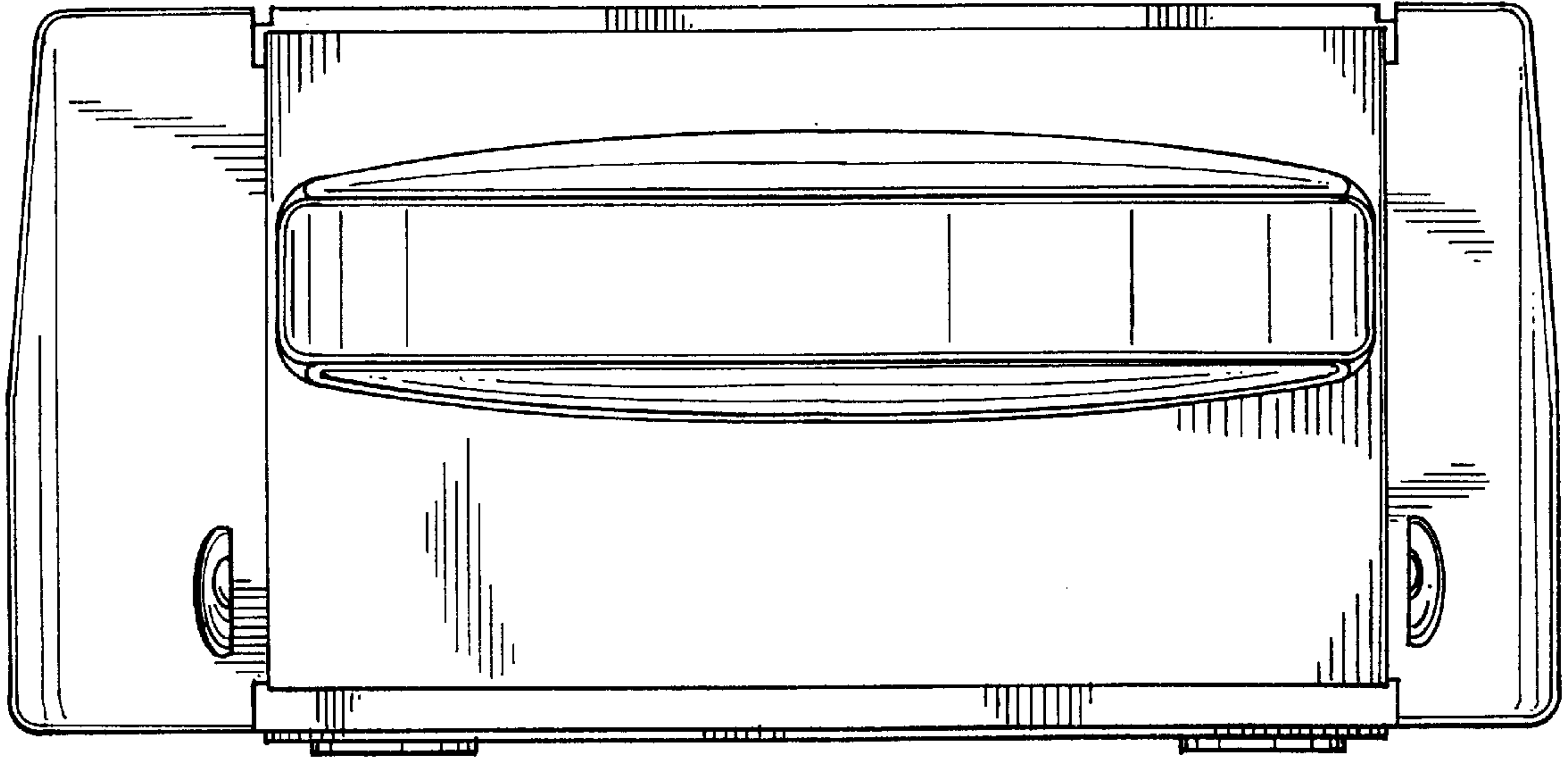

FIG. 5

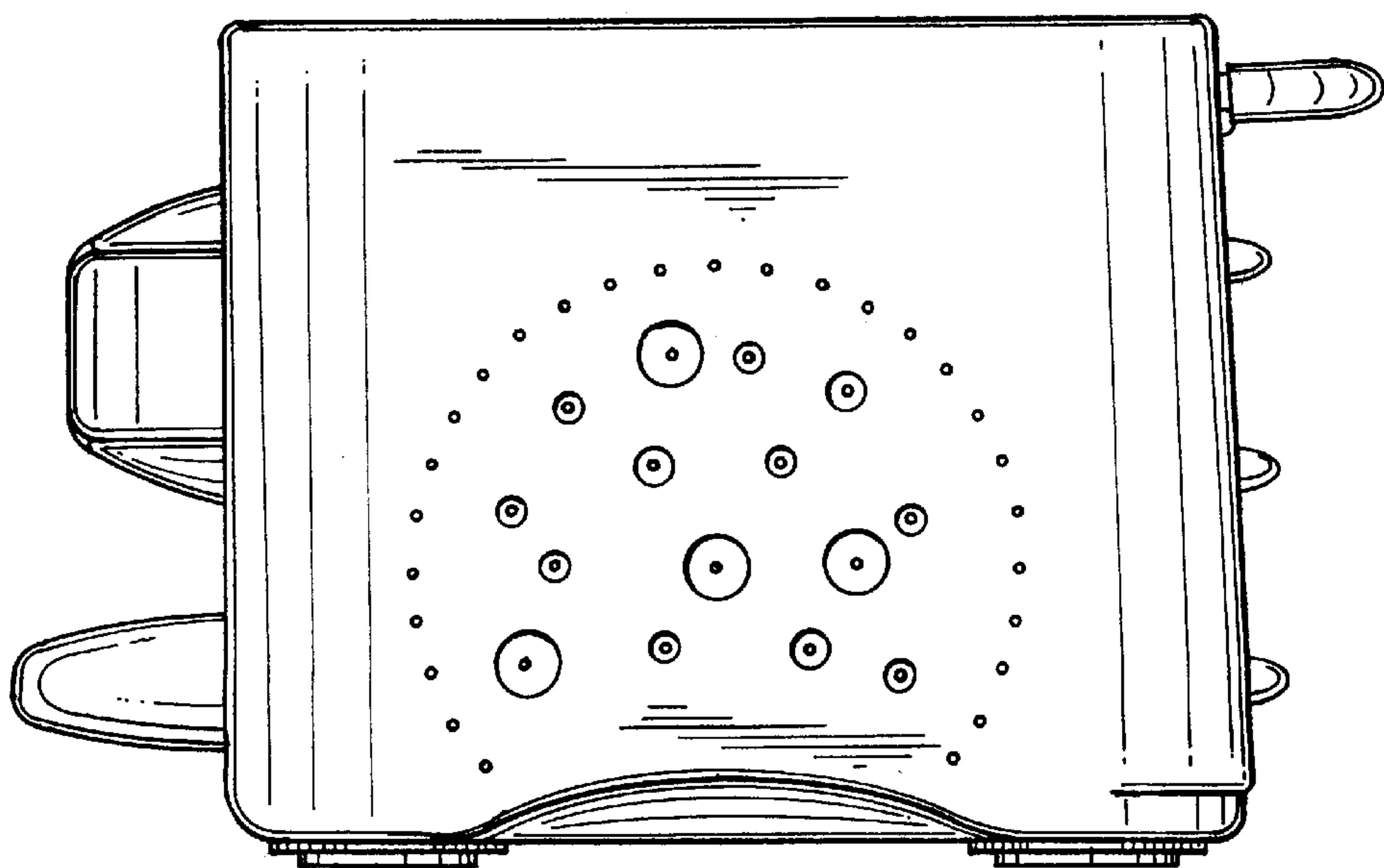

FIG. 6

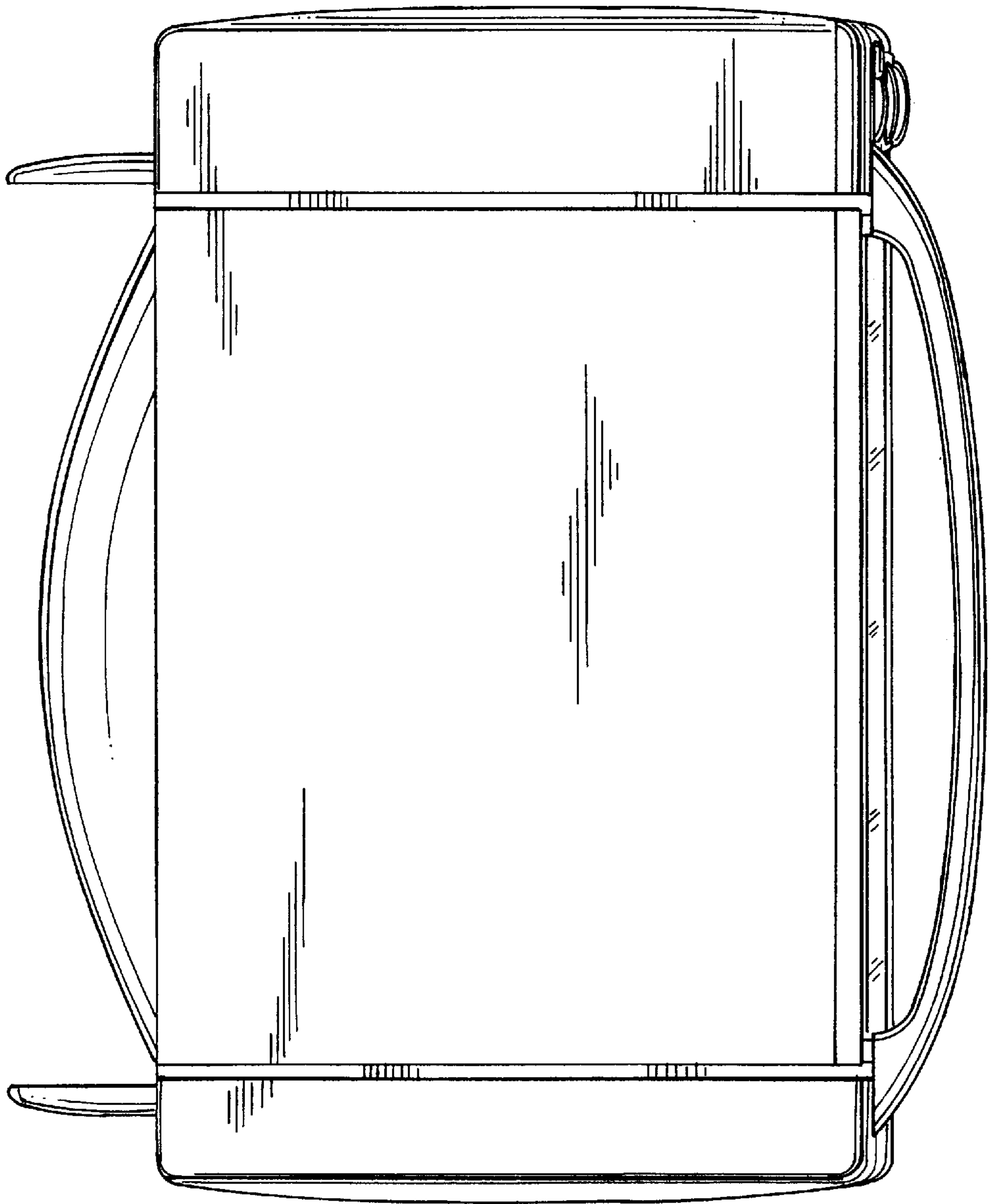

FIG. 7

