



US00D412611S

United States Patent [19] Simpson

[11] **Patent Number: Des. 412,611**

[45] **Date of Patent: ** Aug. 10, 1999**

[54] **IMPLEMENT HOLDER ATTACHED TO A HAT OR CAP**

5,509,634 4/1996 Gebka et al. 248/316.7
5,829,103 11/1998 Allen 24/11 R

[76] Inventor: **David Simpson**, 3381 "E" Rd.,
Loxahatchee, Fla. 33470

Primary Examiner—Paula A. Mortimer
Attorney, Agent, or Firm—Tom Hamill, Jr.

[**] Term: **14 Years**

[57] **CLAIM**

[21] Appl. No.: **29/089,010**

I claim the ornamental design for the implement holder attached to a hat or cap, as shown and described.

[22] Filed: **Jun. 5, 1998**

DESCRIPTION

[51] **LOC (6) Cl.** **02-03**

[52] **U.S. Cl.** **D2/891**

[58] **Field of Search** D2/865, 891; D3/207;
D8/377, 380, 388; D19/65, 99, 100; 24/10 R,
11 R, 11 M, 11 PP, 3.3, 3.4, 3.6, 3.12,
336, 3.1; 248/216.7, 902

FIG. 1 is an environmental perspective view of the implement holder attached to a cap or hat showing my new design, the broken line showing the cap and the pencil is for illustrative purposes only and forms no part of the claimed design,

FIG. 2 is an enlarged front perspective view thereof,

FIG. 3 is a front view thereof,

FIG. 4 is a rear side view thereof,

FIG. 5 is a top side view thereof,

FIG. 6 is a bottom view thereof,

FIG. 7 is a right side view thereof; and,

FIG. 8 is a left side view thereof.

[56] **References Cited**

U.S. PATENT DOCUMENTS

D. 308,935 7/1990 Leatherman D8/395
1,425,089 8/1922 Henry 24/3.12
1,704,075 3/1929 Brown 24/10 R
3,983,602 10/1976 Barry 24/11 R
5,066,154 11/1991 Renaud 24/3.12

1 Claim, 8 Drawing Sheets

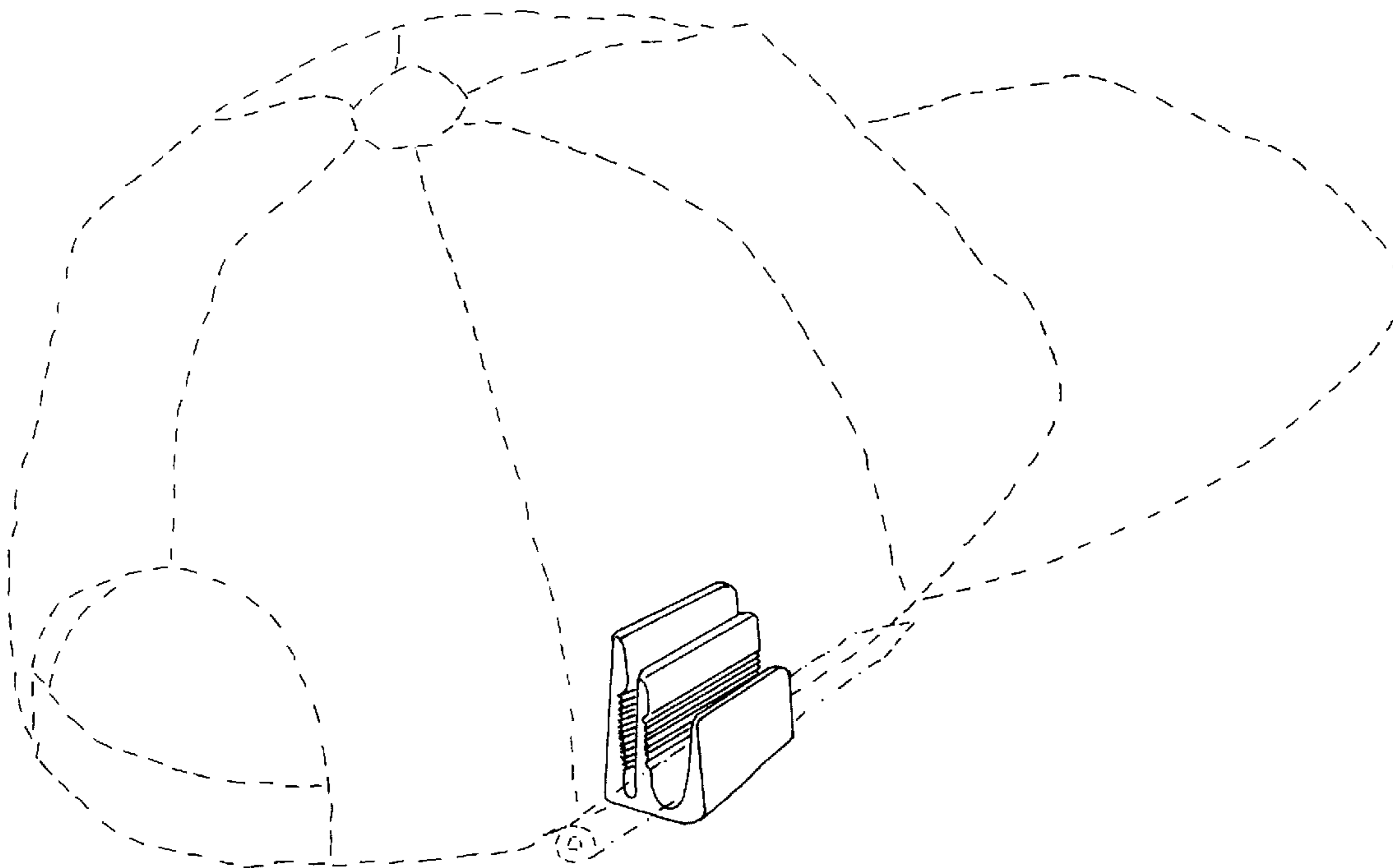

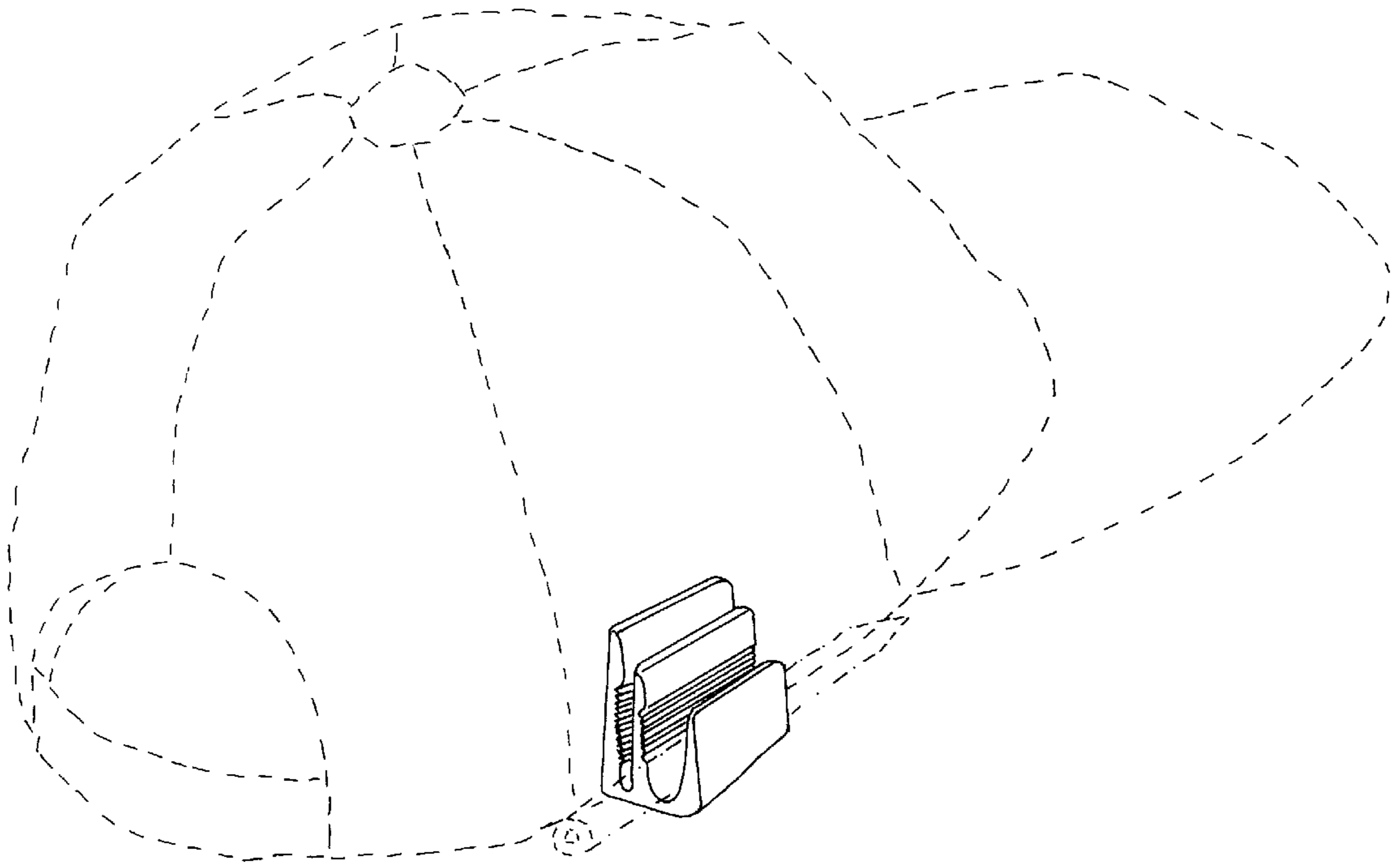

FIGURE 1

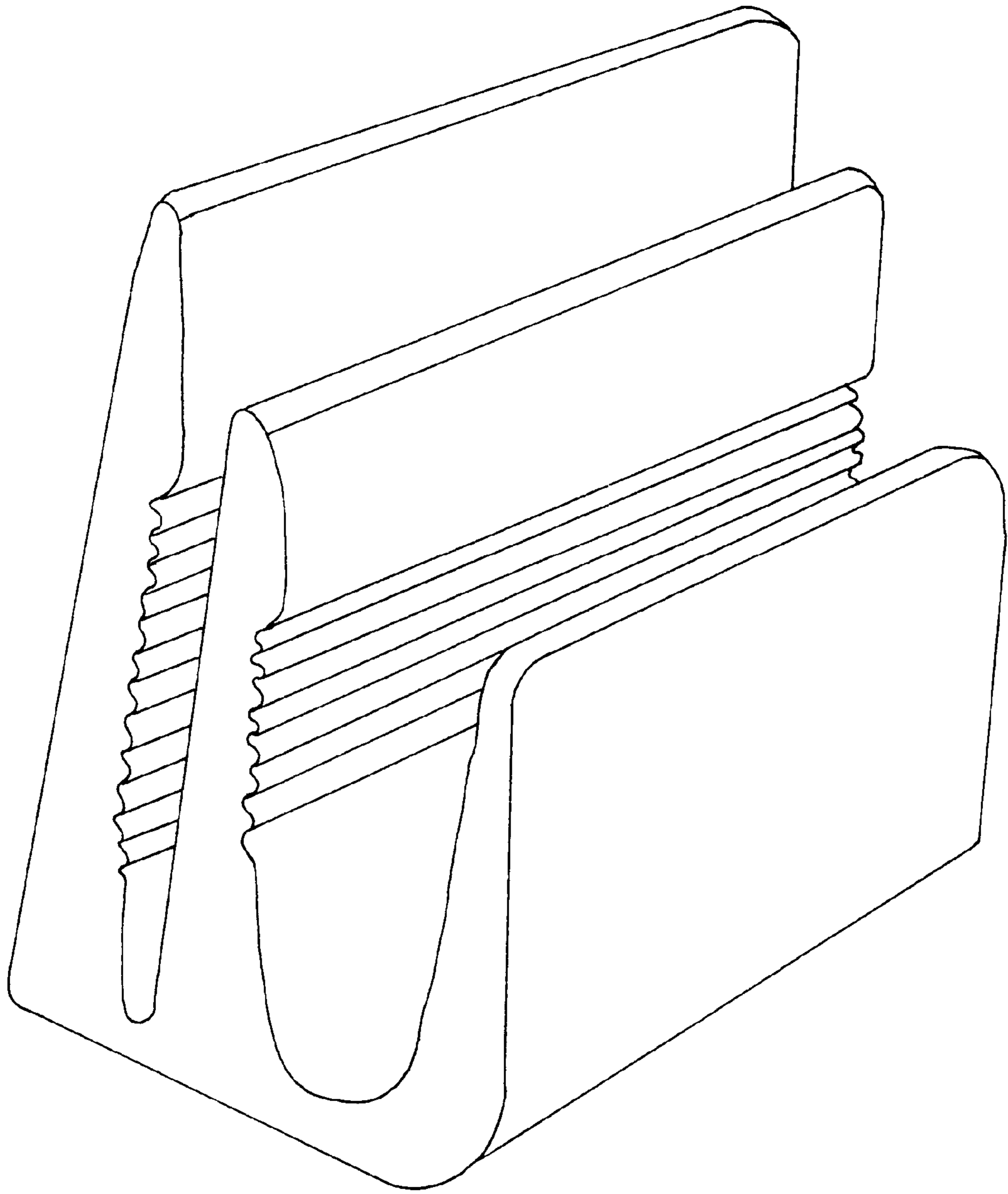

FIGURE 2

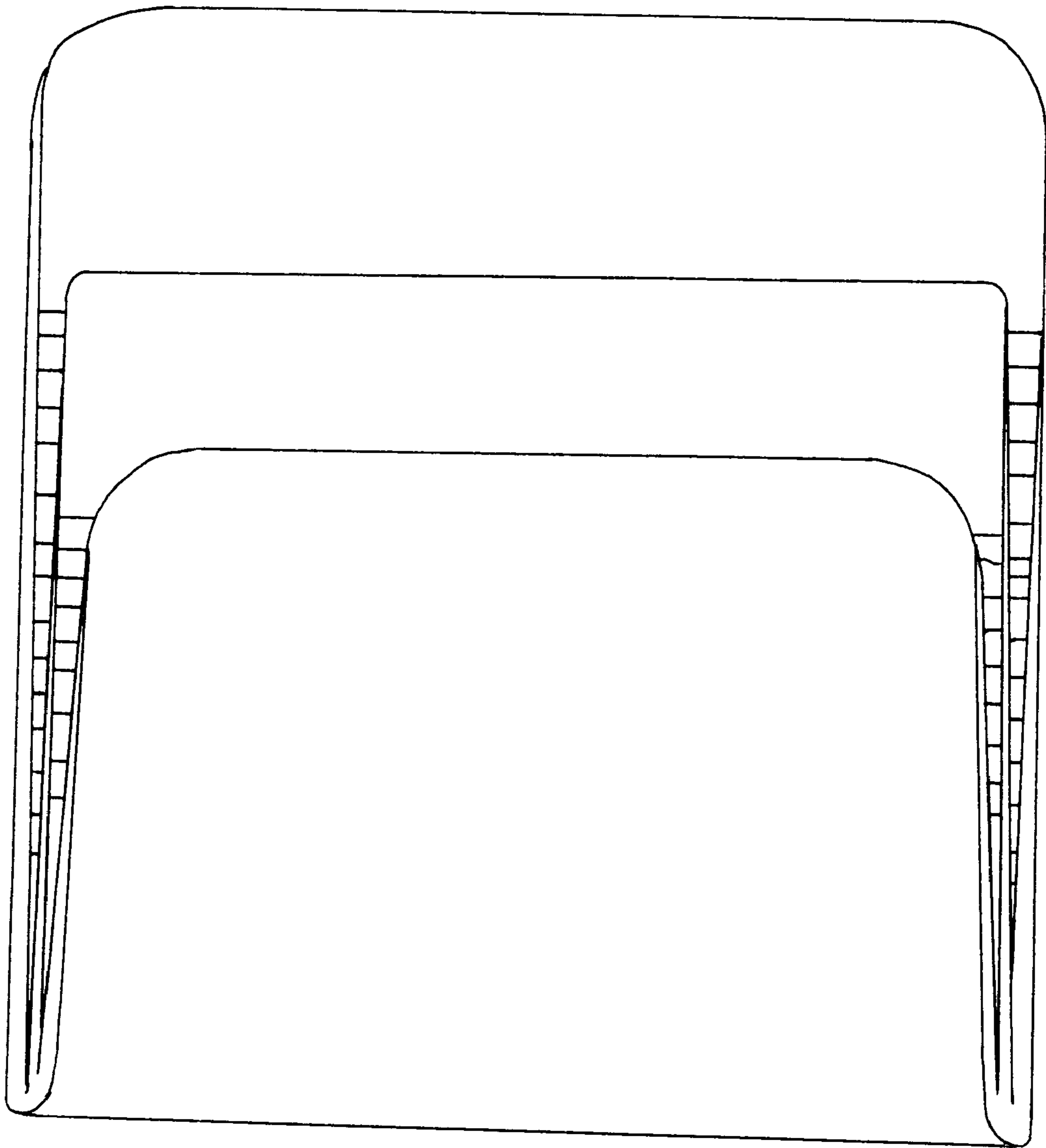

FIGURE 3

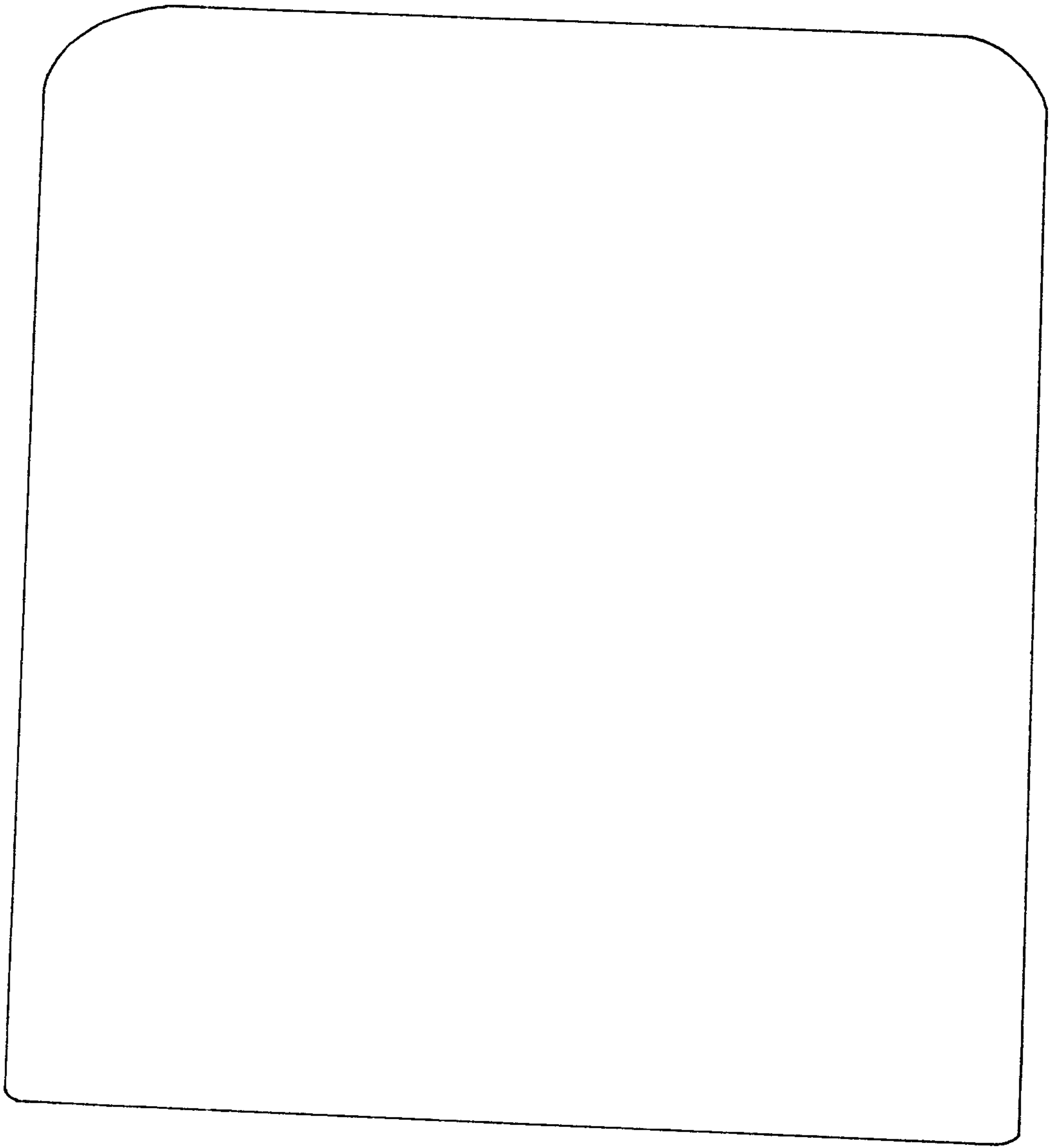

FIGURE 4

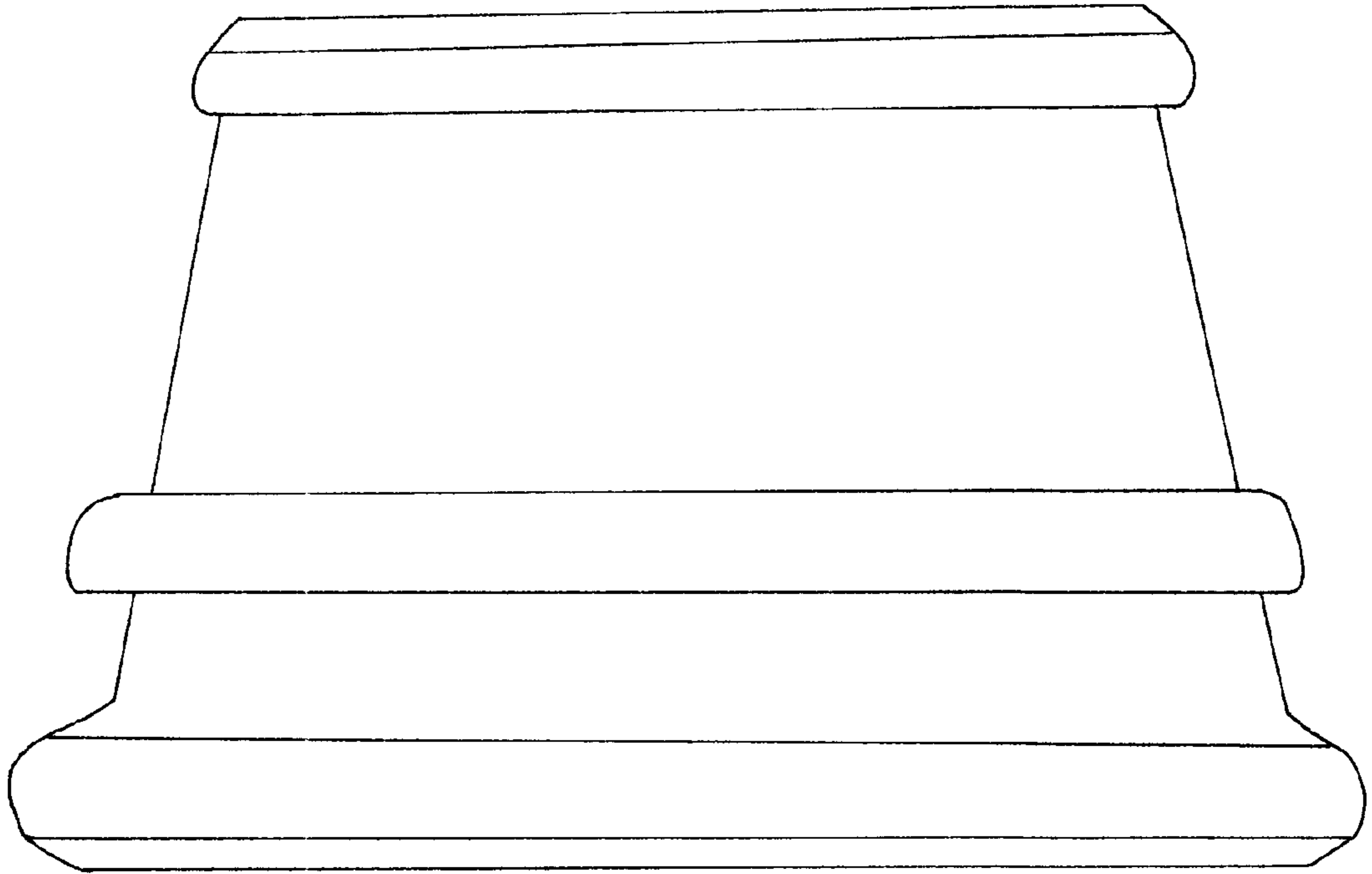

FIGURE 5

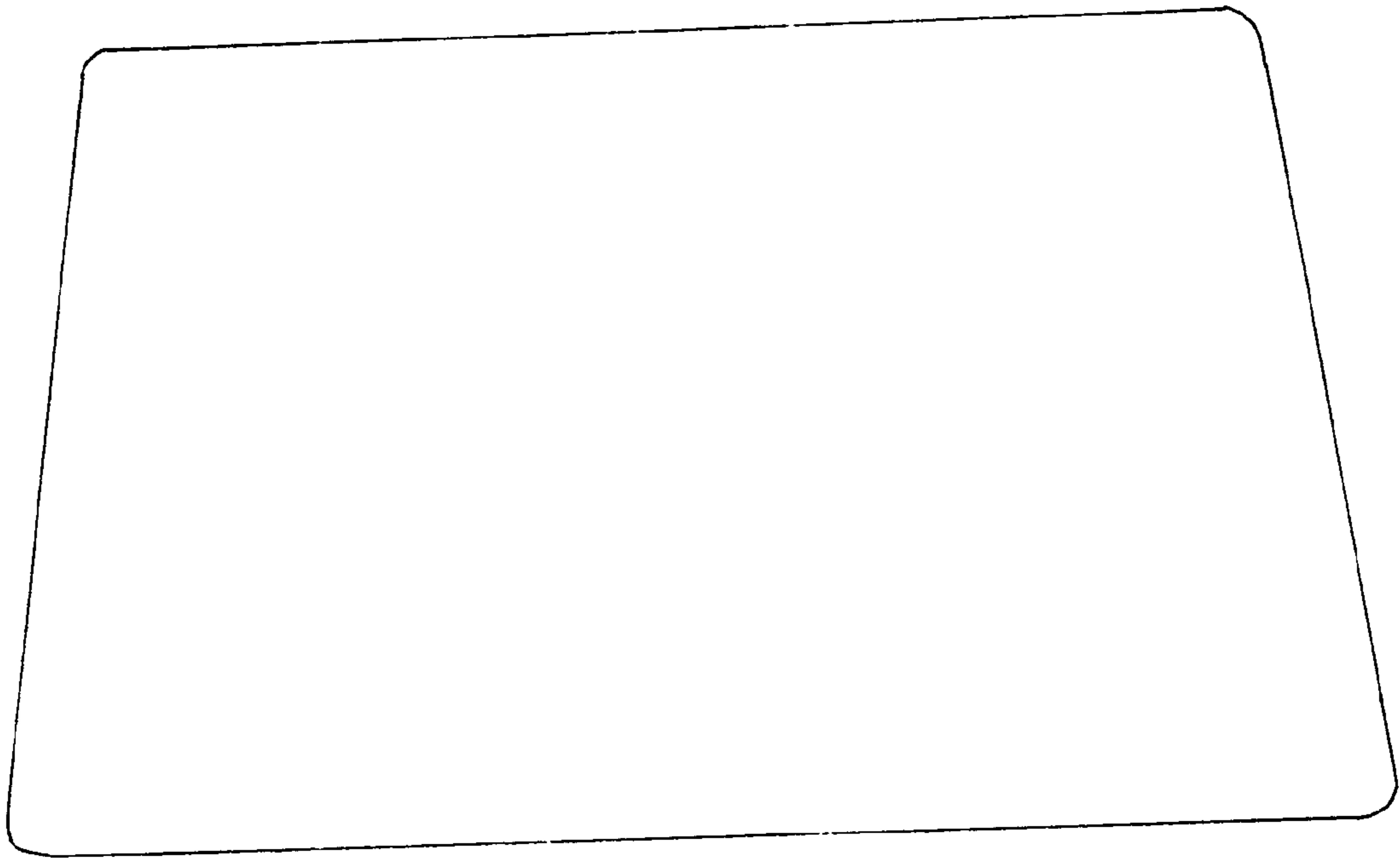

FIGURE 6

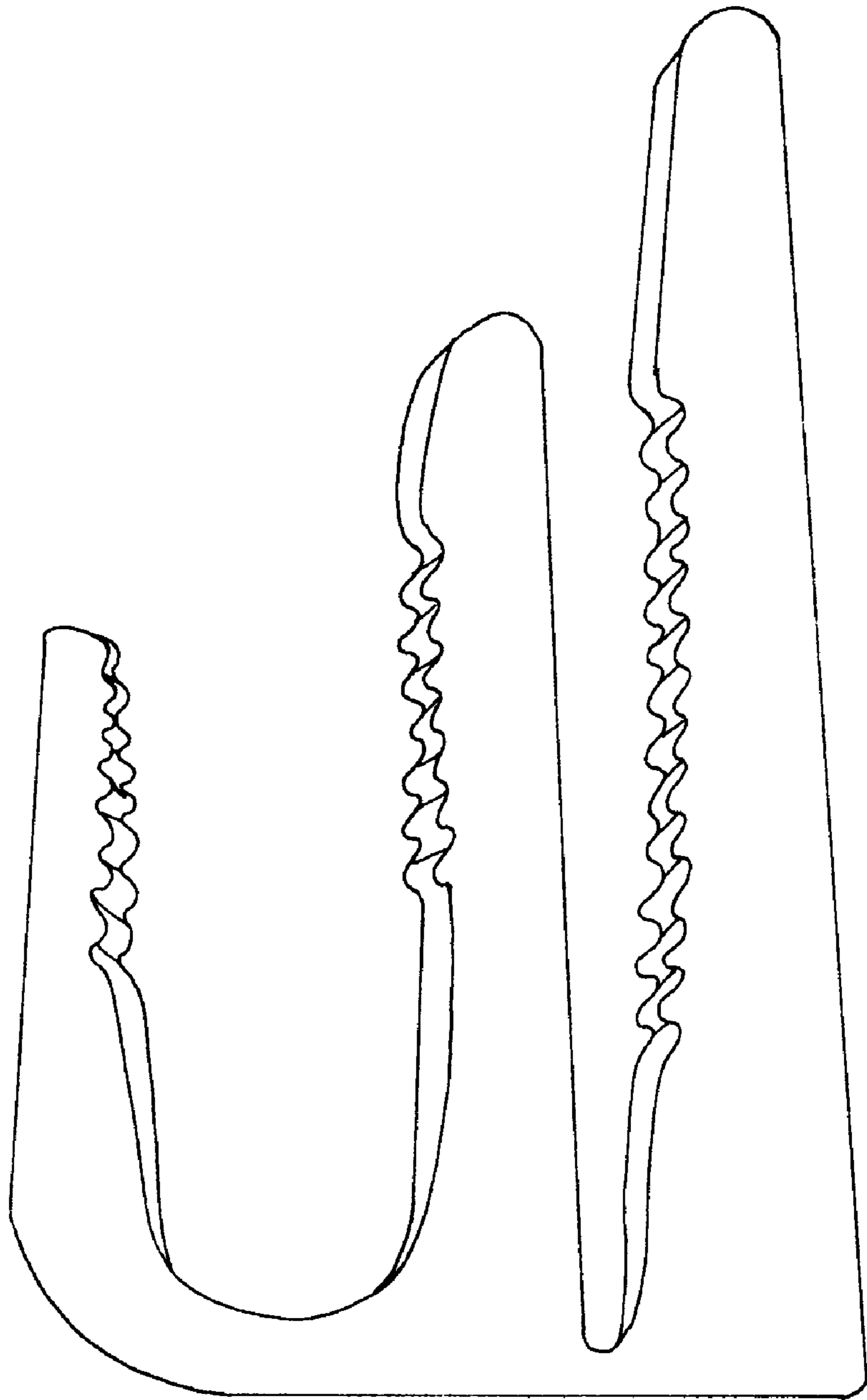

FIGURE 7

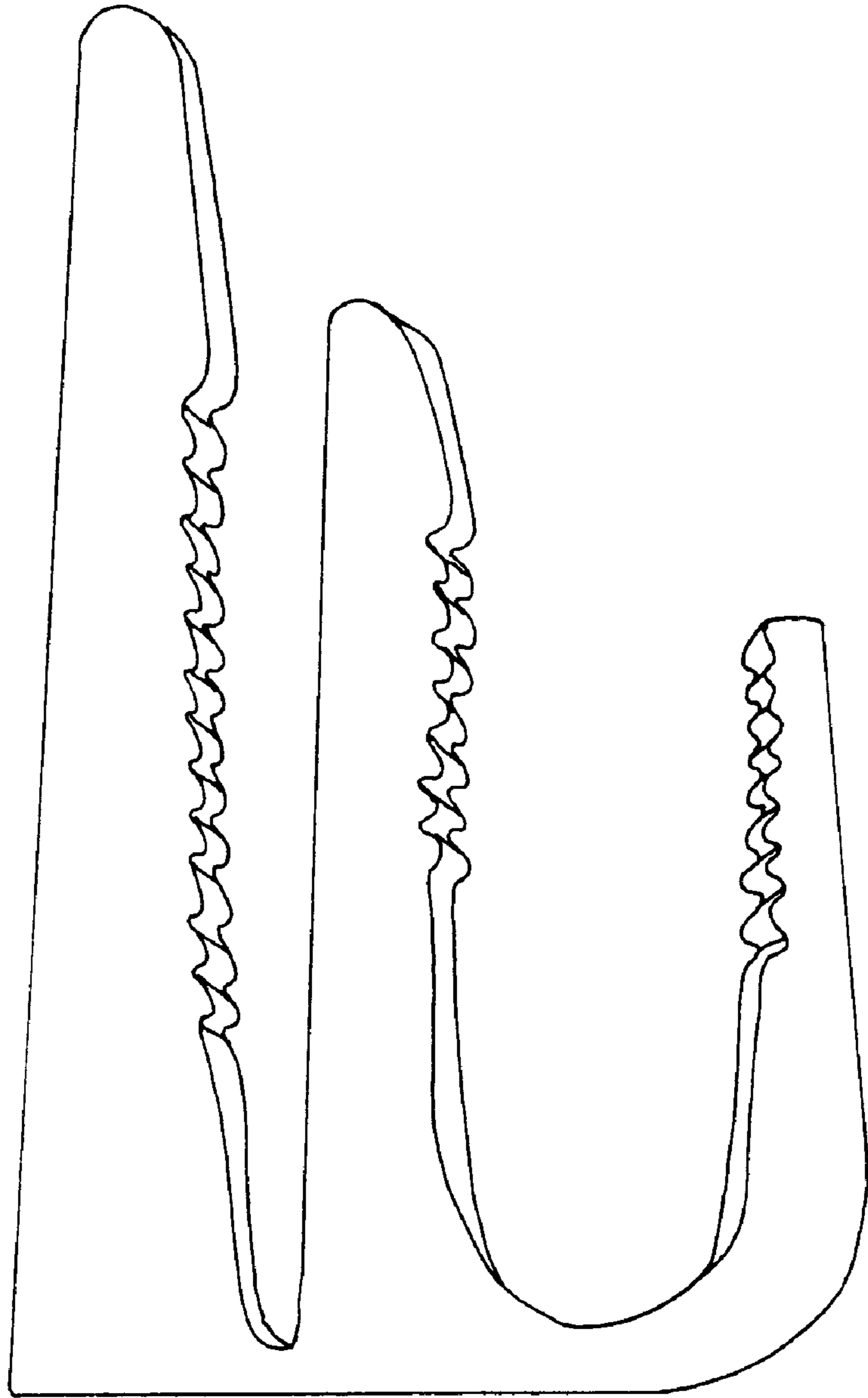

FIGURE 8