



US00D412597S

United States Patent [19] Bauer

[11] Patent Number: **Des. 412,597**

[45] Date of Patent: **** Aug. 3, 1999**

[54] **HAIR COLORING SET**

[76] Inventor: **Pamela J. Bauer**, 813 Denier Pl., Cincinnati, Ohio 45224-0311

[**] Term: **14 Years**

[21] Appl. No.: **29/073,304**

[22] Filed: **Jul. 21, 1997**

[51] **LOC (6) Cl.** **28-03**

[52] **U.S. Cl.** **D28/20; D28/7; D28/77; D28/89; D9/302; D9/337**

[58] **Field of Search** D28/7, 76, 77, D28/9, 10, 20, 88, 89; D9/337, 302, 338, 436, 442, 447; 132/200, 208, 216, 218, 317, 318, 320, 212; D4/114, 116; 206/581, 229, 209, 210, 362.3, 15.2, 15.3, 219-222, 568, 572, 575, 363; 401/4, 11, 118-130, 132; D19/41, 43, 51; 222/575, 92, 94, 97, 107, 541.1, 541.2, 541.5, 541.6, 541.9; 215/347-49, DIG. 8

[56] **References Cited**

U.S. PATENT DOCUMENTS

D. 120,353	5/1940	Osterhoudt	D9/442
2,321,333	6/1943	Terry	401/134
2,682,974	7/1954	Smith	222/107
2,829,655	4/1958	Bau	132/218
4,392,492	7/1983	Pick	206/219 X
4,804,004	2/1989	Taylor	401/129 X

5,180,242	1/1993	De Laforcade	401/132
5,209,565	5/1993	Goncalves	206/220 X
5,554,197	9/1996	Assini et al.	132/208 X

FOREIGN PATENT DOCUMENTS

3240151	5/1984	Germany	401/129
6315410	11/1994	Japan	132/208

OTHER PUBLICATIONS

Drug & Cosmetic Industry Dec. 1979, p. 79: three containersat right.

Beauty Boutique Spring 1994, p. 20: tube container on lower left

Primary Examiner—Philip S. Hyder

Assistant Examiner—L. Tuttle

[57] CLAIM

The ornamental design for a hair coloring set, as shown.

DESCRIPTION

FIG. 1 is a front elevational view of the hair coloring set of the present invention;

FIG. 2 is a rear elevational view thereof;

FIG. 3 is a right side elevational view thereof;

FIG. 4 is a left side elevational view thereof;

FIG. 5 is a top plan view thereof;

FIG. 6 is a bottom plan view thereof; and,

FIG. 7 is an exploded perspective view thereof.

1 Claim, 3 Drawing Sheets

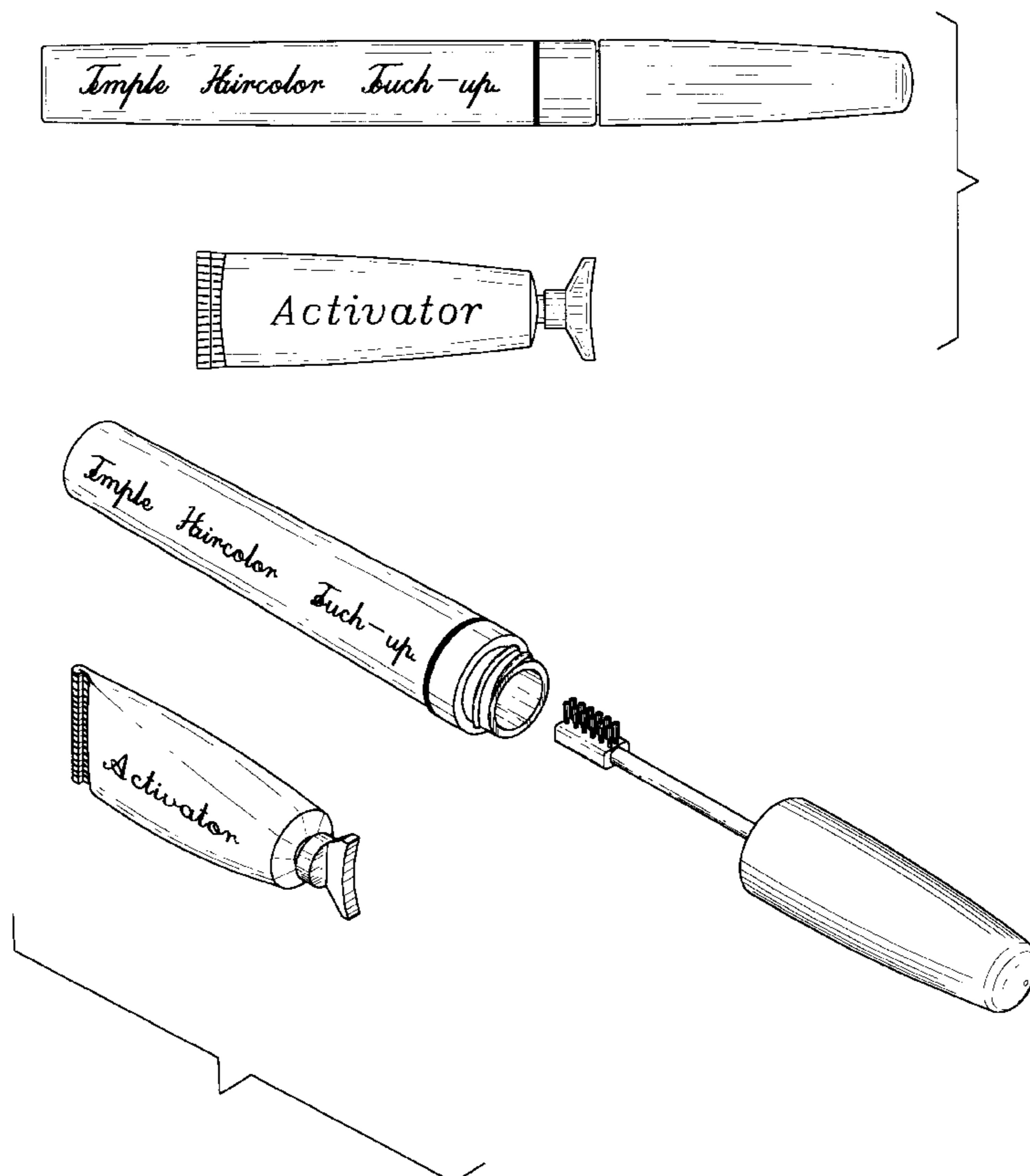

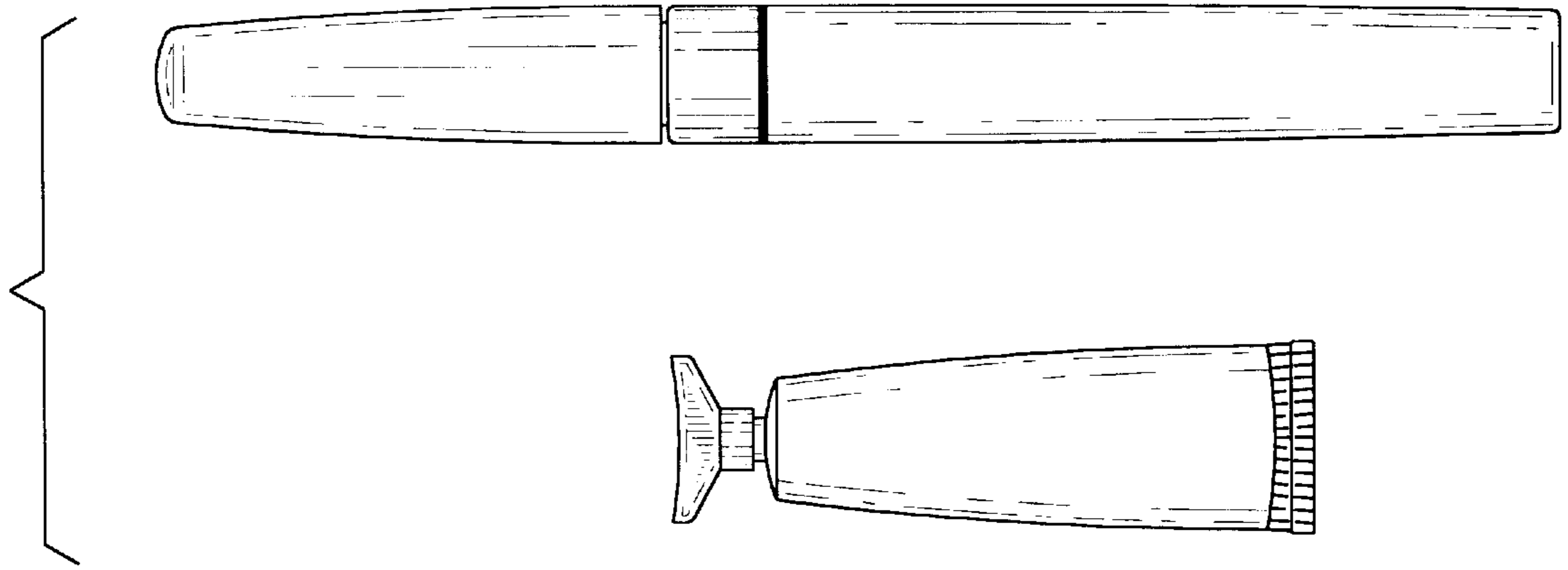

Fig. 2

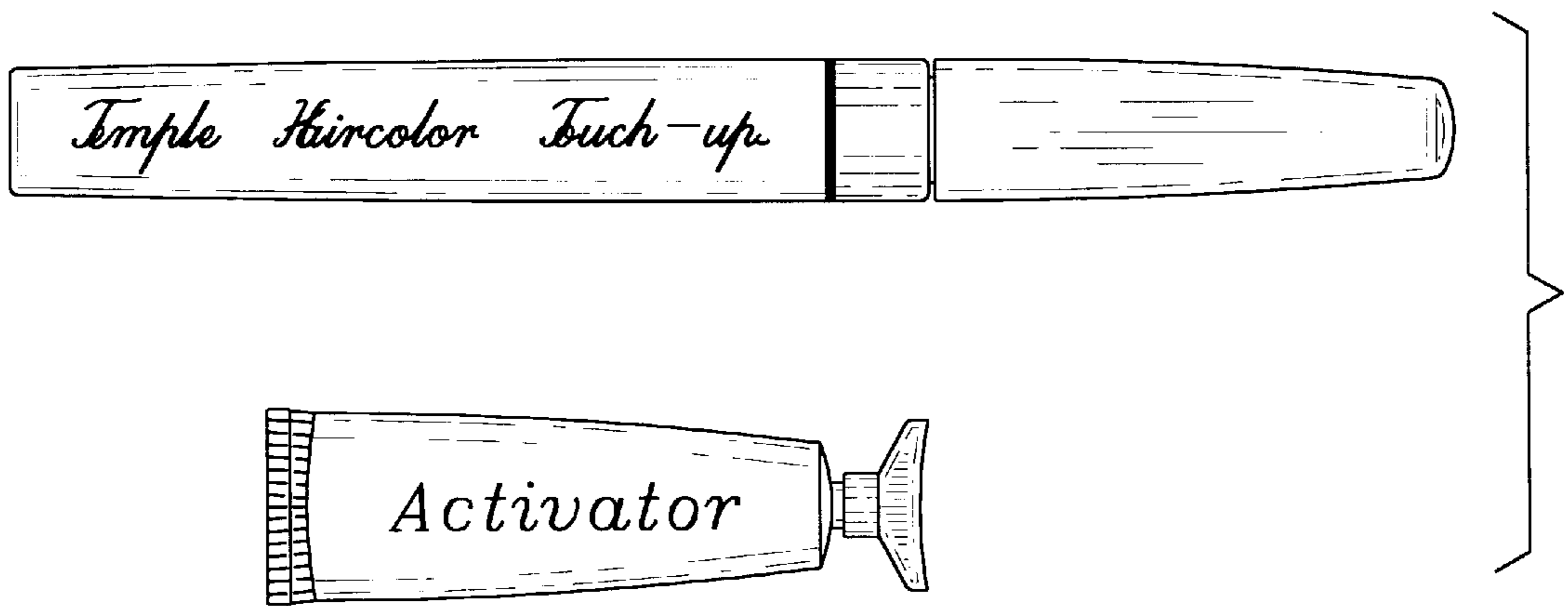

Fig. 1

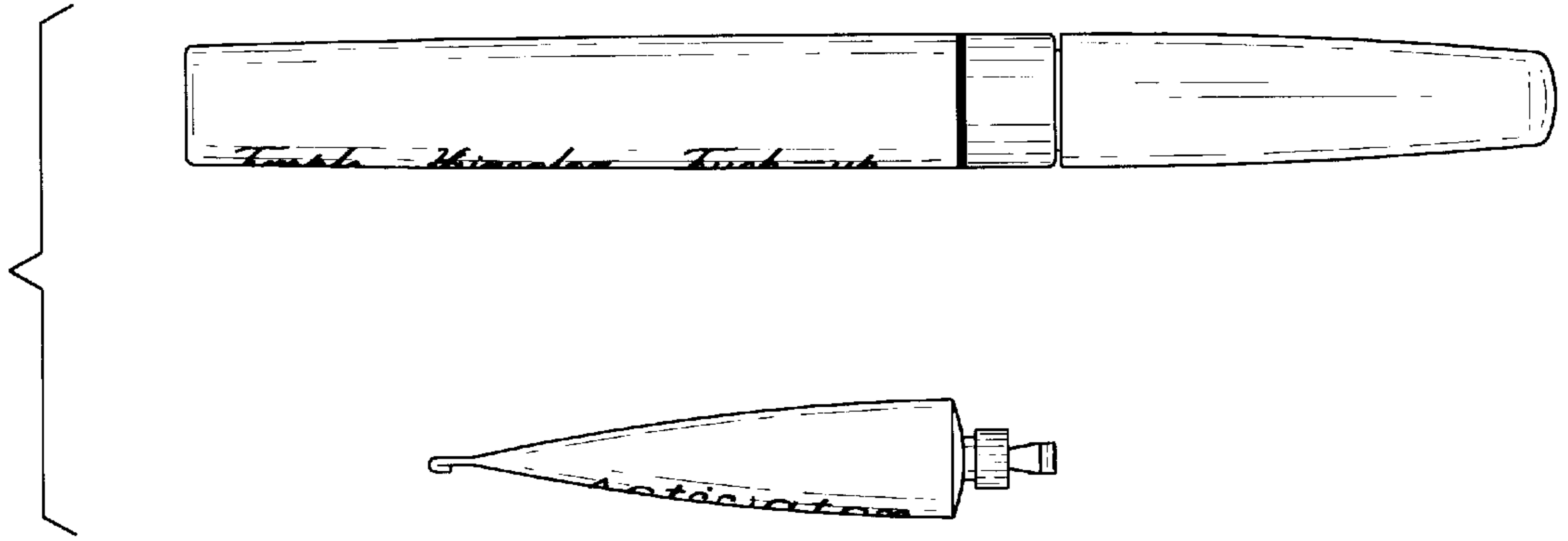

Fig. 5

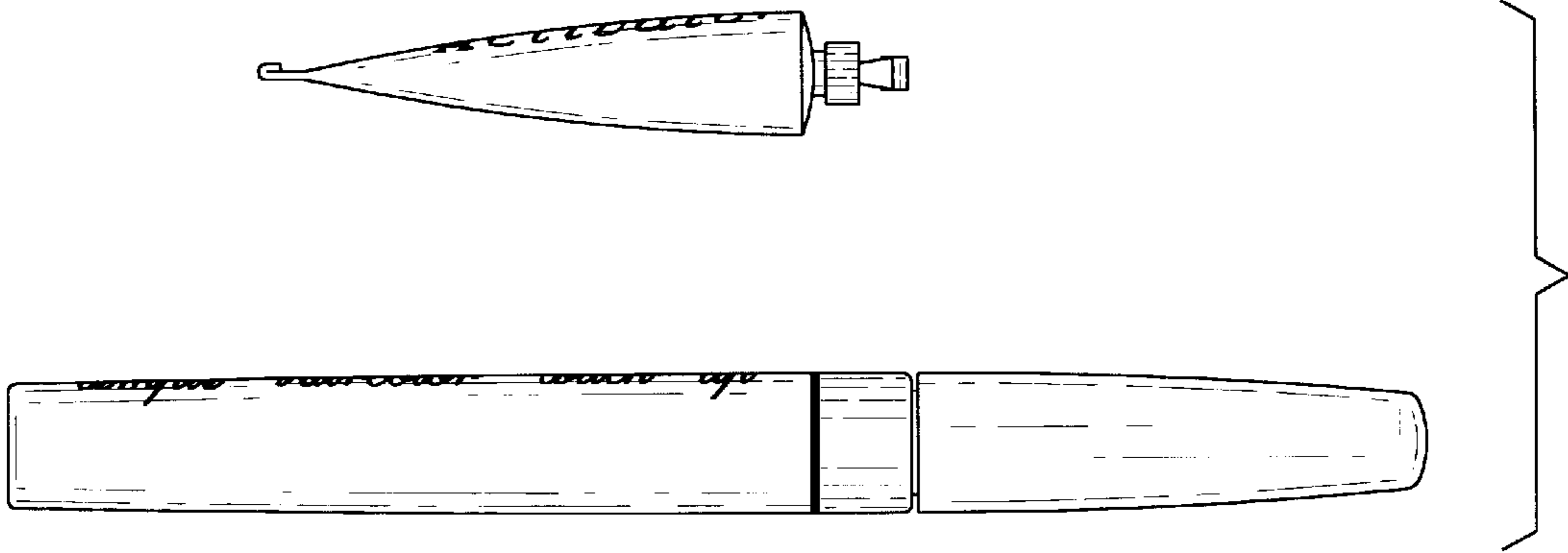

Fig. 6

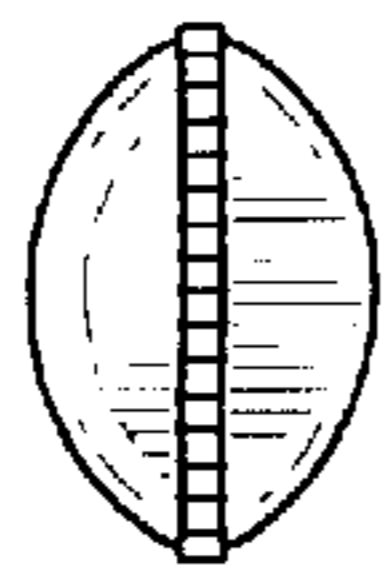

Fig. 3

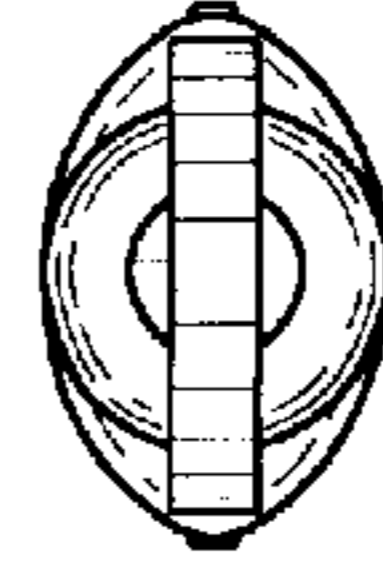
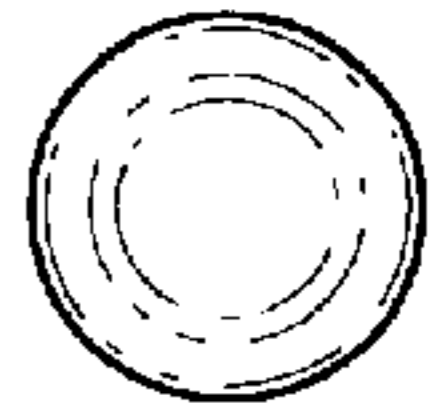

Fig. 4

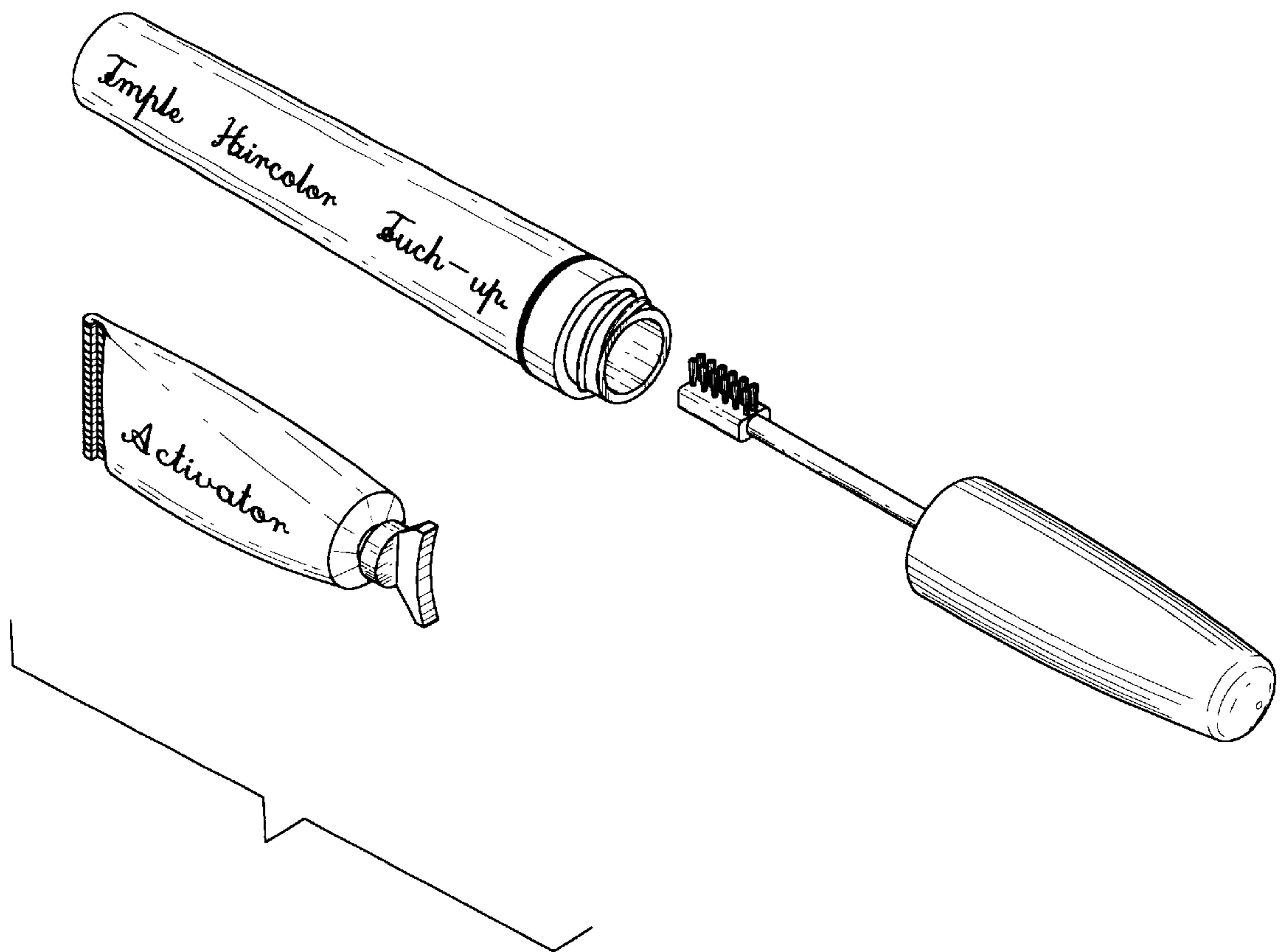

Fig. 7