



US00D412550S

**United States Patent** [19]  
**Bell**

[11] **Patent Number: Des. 412,550**

[45] **Date of Patent: \*\* Aug. 3, 1999**

[54] **WATER DISTILLATION UNIT**

[75] Inventor: **Jeffrey Bell**, Monroe, Nebr.

[73] Assignee: **Pure Water, Inc.**, Lincoln, Nebr.

[\*\*] Term: **14 Years**

[21] Appl. No.: **29/087,741**

[22] Filed: **May 8, 1998**

[51] **LOC (6) Cl.** ..... **23-01**

[52] **U.S. Cl.** ..... **D23/207**

[58] **Field of Search** ..... D23/200, 207,  
D23/209; D7/309; 202/81, 83, 185.2; 203/10,  
12

[56] **References Cited**

**U.S. PATENT DOCUMENTS**

D. 195,771	7/1963	Soussloff	.....	D23/207
D. 267,032	11/1982	Lafontaine	.....	D23/209
D. 314,225	1/1991	Palmer et al.	.....	D23/207
D. 341,871	11/1993	Bannigan	.....	D23/209
D. 389,556	1/1998	Feldman et al.	.....	D23/207
5,217,580	6/1993	Chen	.....	202/185.2
5,662,779	9/1997	Greene et al.	.....	202/83

*Primary Examiner*—Alan P. Douglas

*Assistant Examiner*—Robin V. Taylor

*Attorney, Agent, or Firm*—Van Dyke, Gardner, Linn & Burkhardt, LLP

[57] **CLAIM**

The ornamental design for the water distillation unit, as shown and described.

**DESCRIPTION**

FIG. 1 is a perspective view from the top, front, right side of the unit;

FIG. 2 is a front elevation thereof;

FIG. 3 is a top plan view thereof;

FIG. 4 is a left side elevation thereof;

FIG. 5 is a rear elevation thereof;

FIG. 6 is a right side elevation thereof;

FIG. 7 is a bottom plan view thereof;

FIG. 8 is the same view as FIG. 1 of an alternative embodiment thereof;

FIG. 9 is the same view as FIG. 2 of the embodiment in FIG. 8;

FIG. 10 is the same view as FIG. 3 of the embodiment in FIG. 8;

FIG. 11 is the same view as FIG. 4 of the embodiment in FIG. 8;

FIG. 12 is the same view as FIG. 5 of the embodiment in FIG. 8;

FIG. 13 is the same view as FIG. 6 of the embodiment in FIG. 8; and,

FIG. 14 is the same view as FIG. 7 of the embodiment in FIG. 8.

The cord in FIGS. 4-7 and 11-14 is shown fragmented to indicate indeterminate length.

**1 Claim, 7 Drawing Sheets**

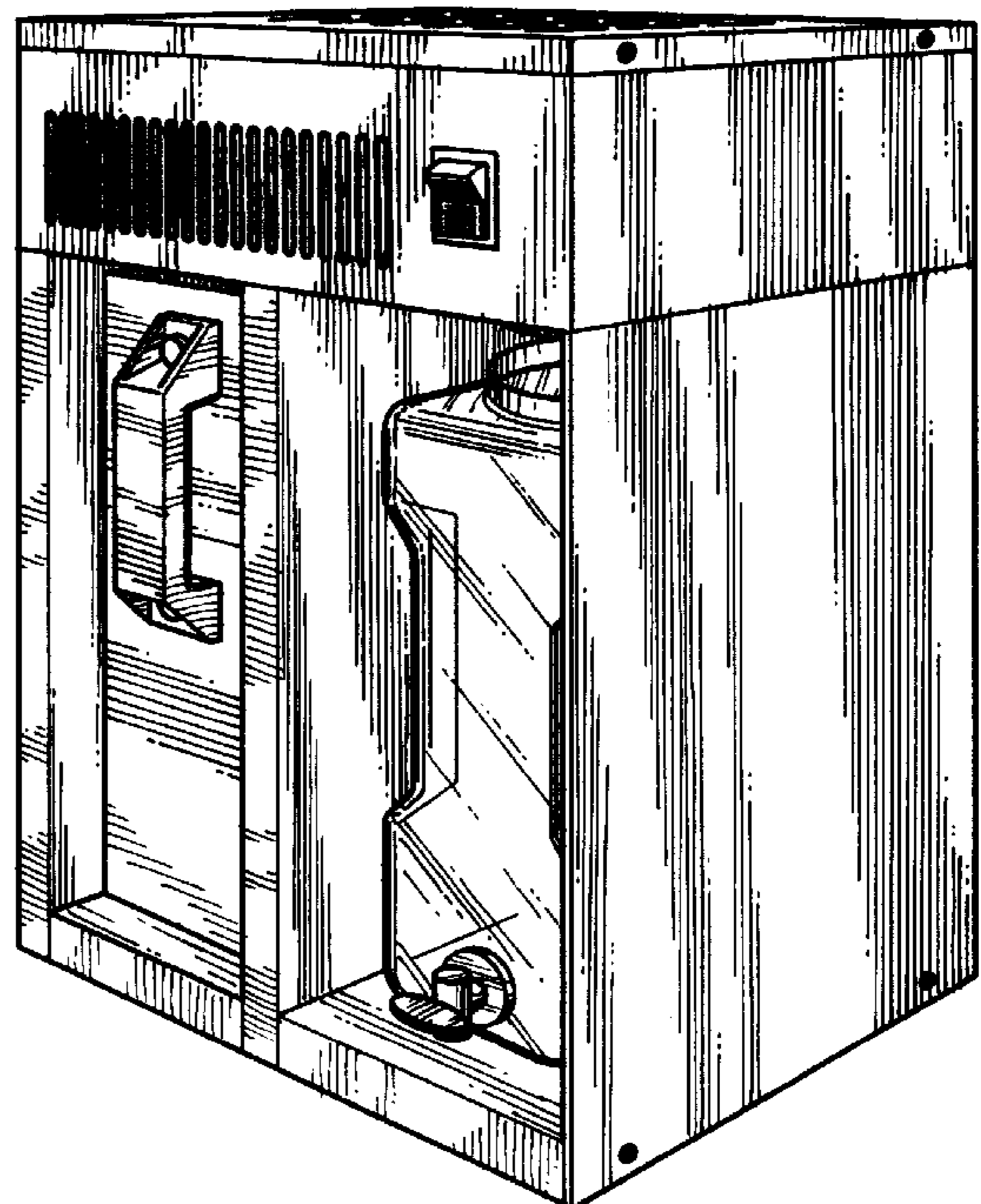
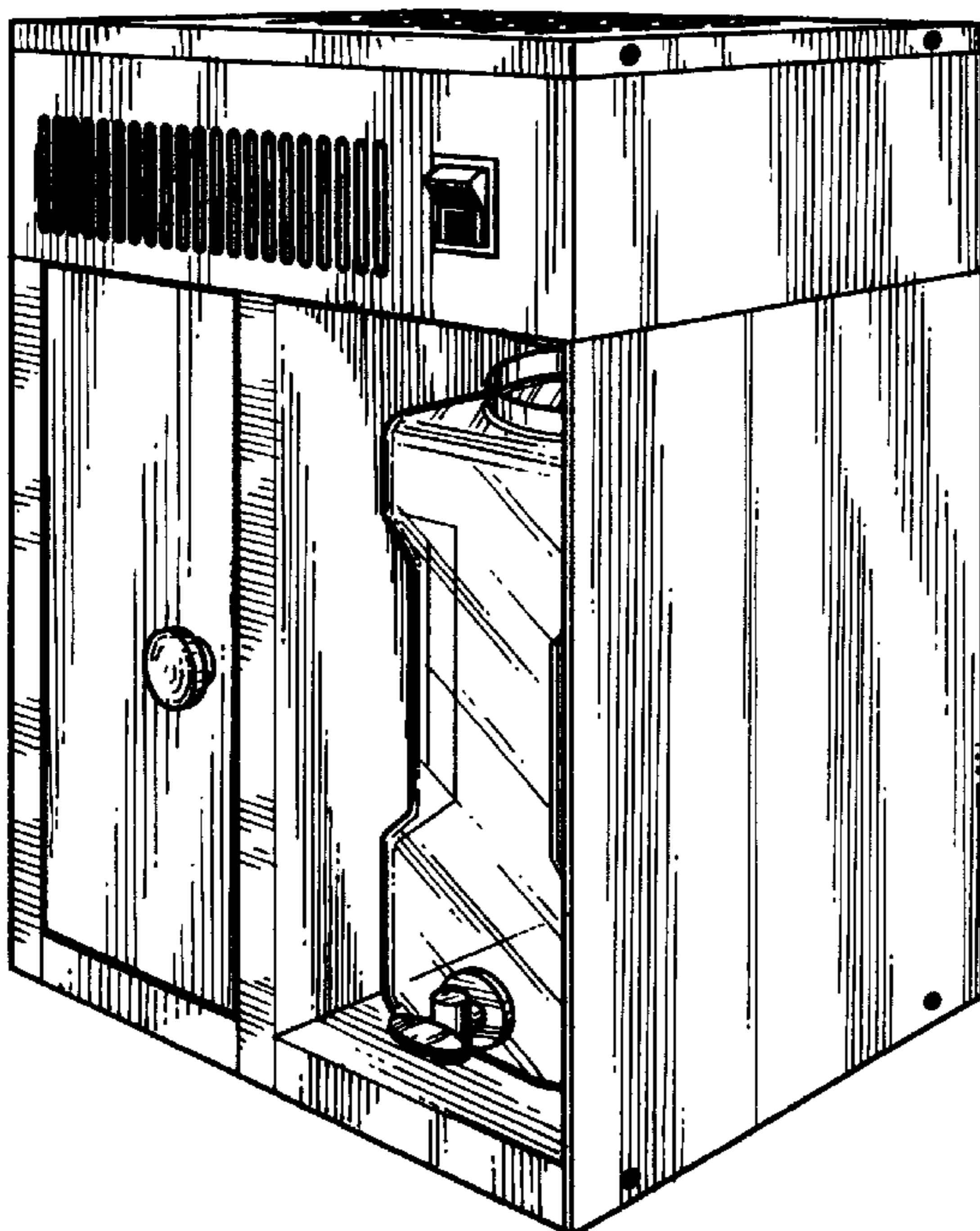

Fig. 1

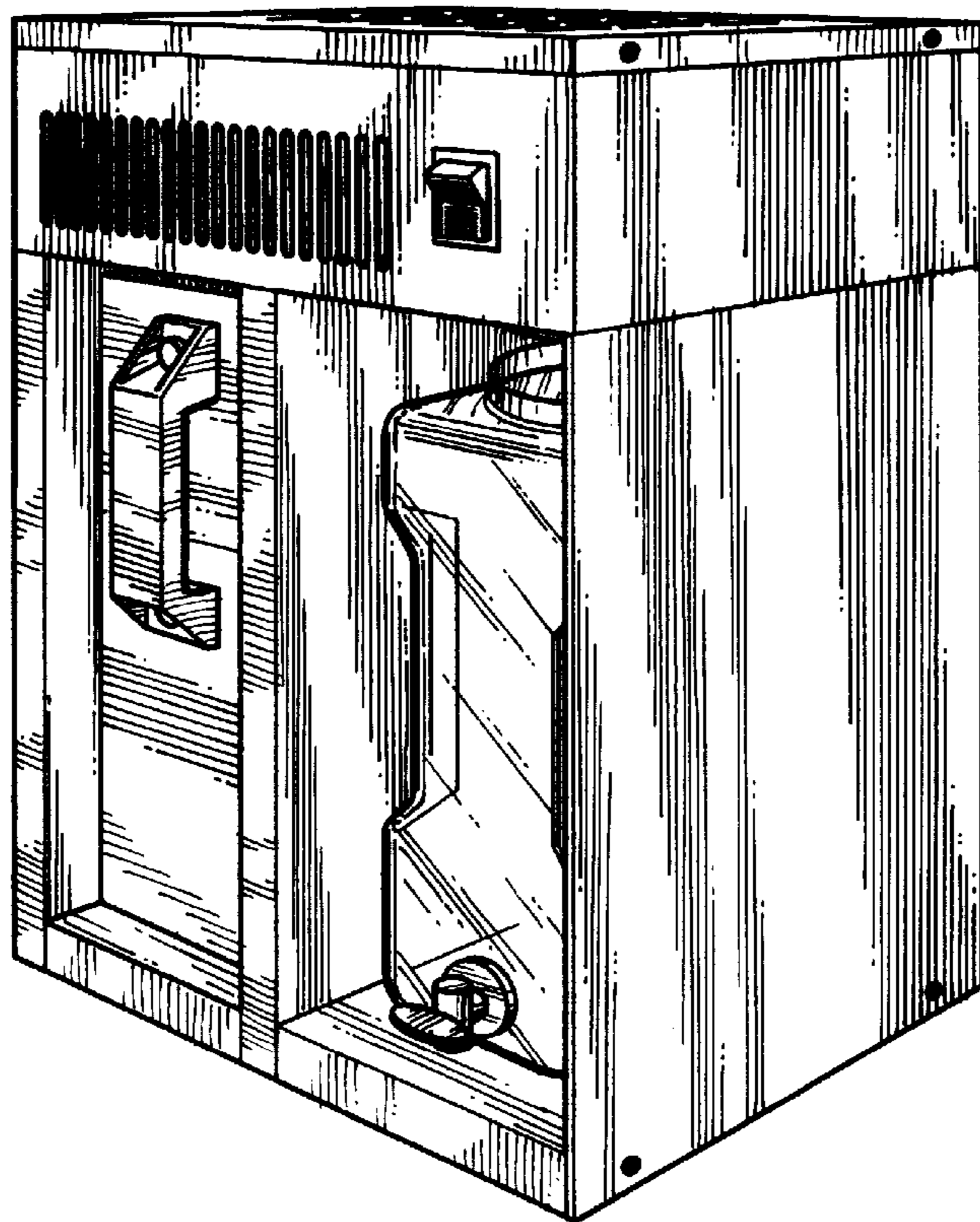
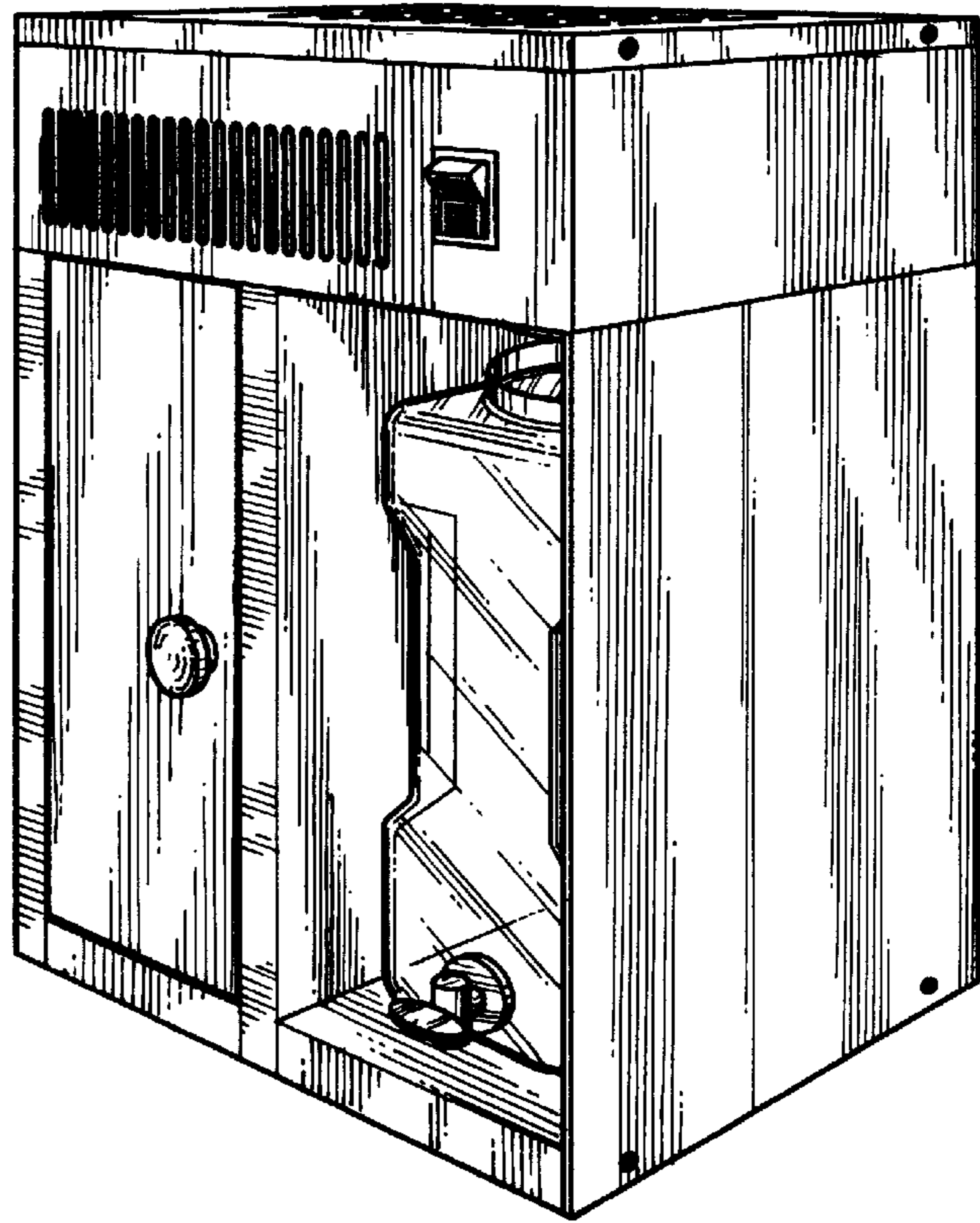

Fig. 8

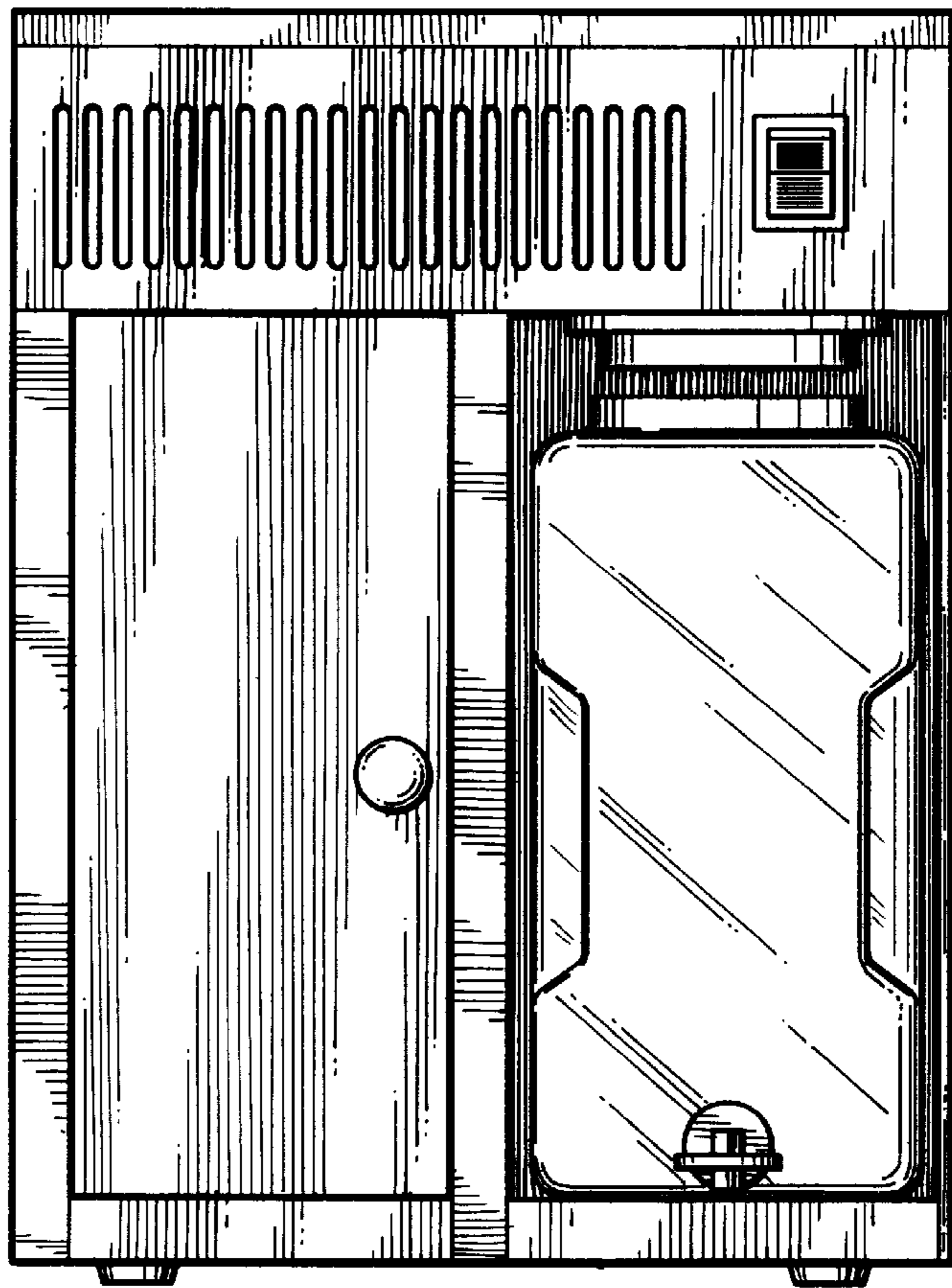

Fig. 2

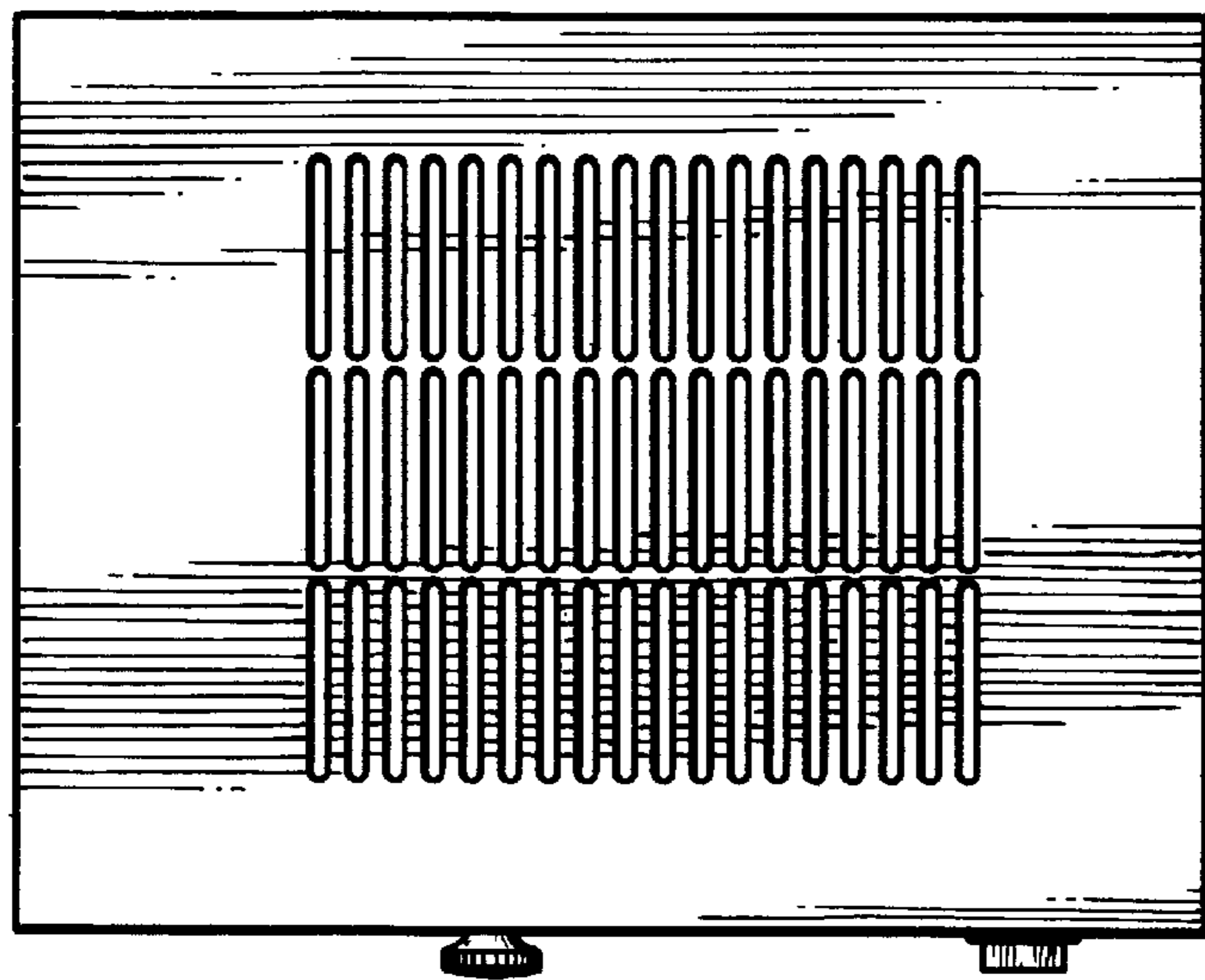

Fig. 3

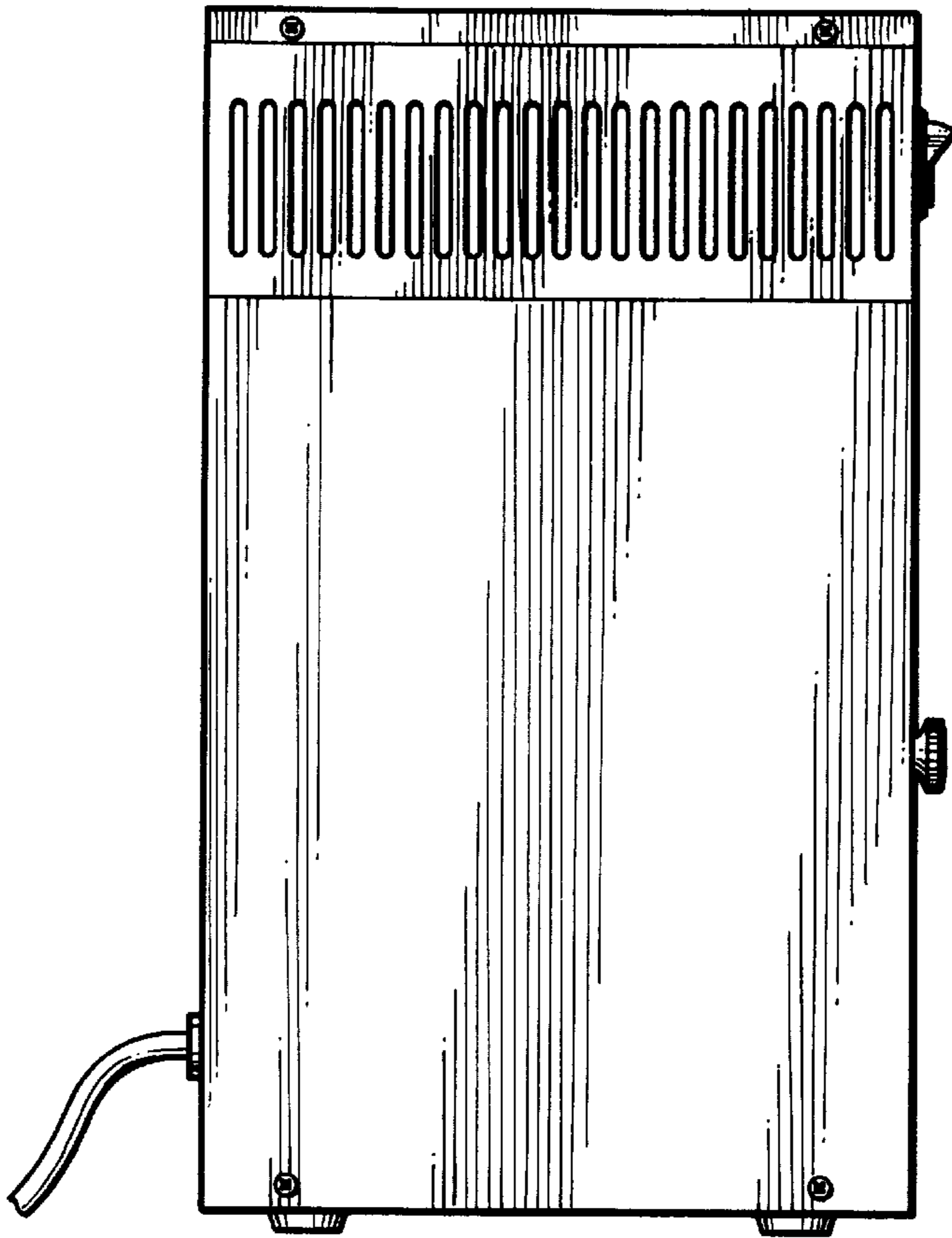

Fig. 4

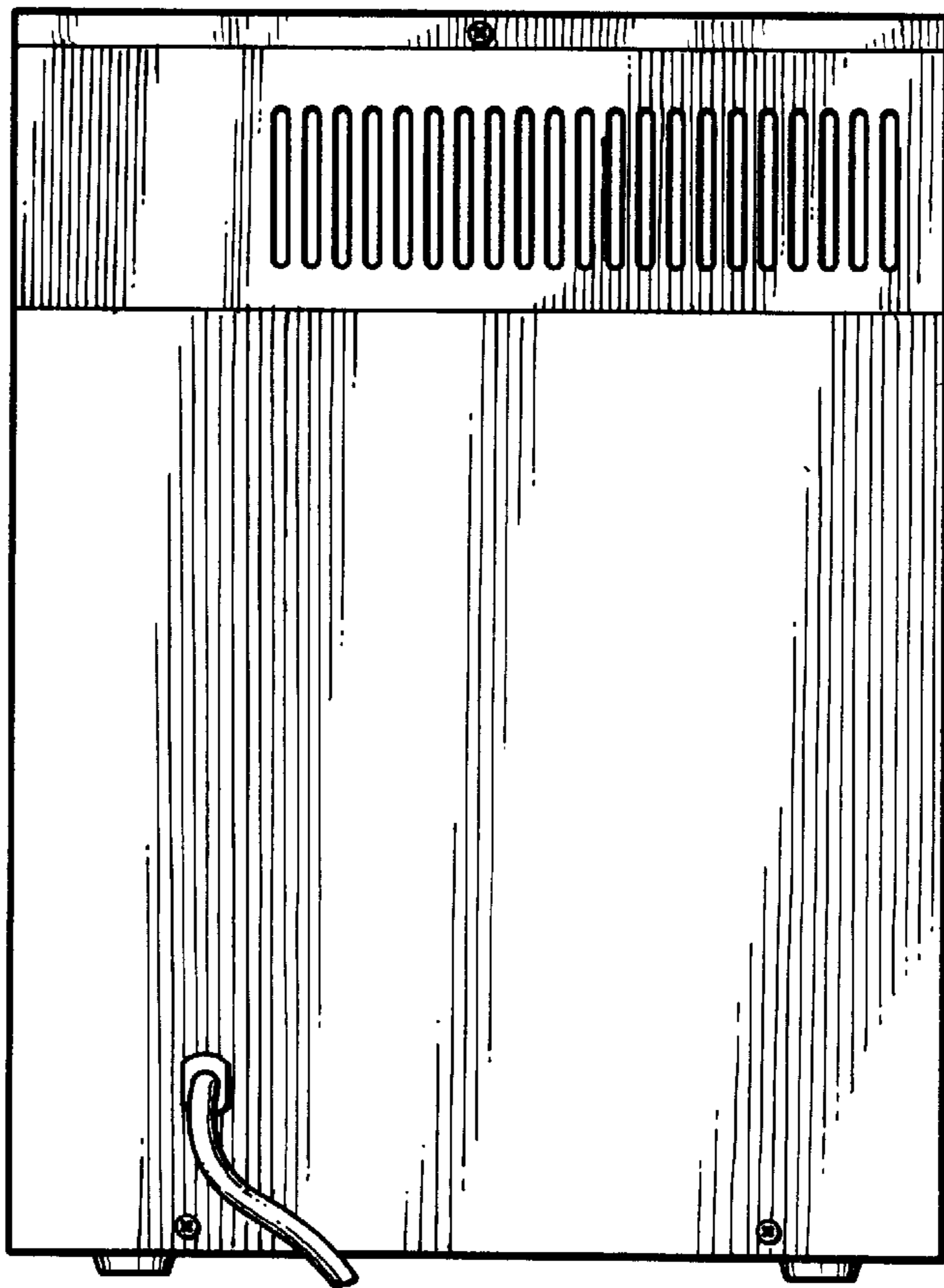

Fig. 5

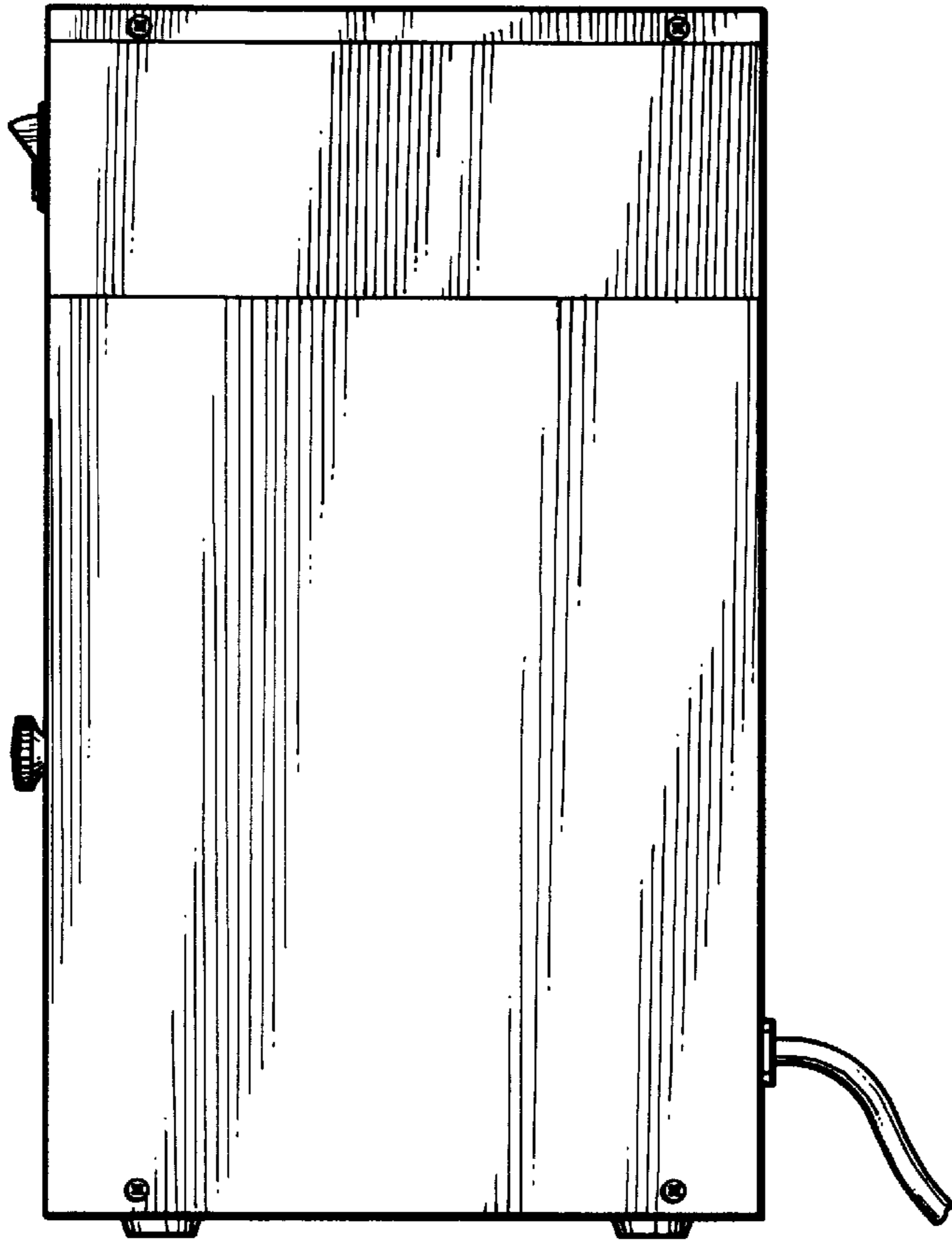

Fig. 6

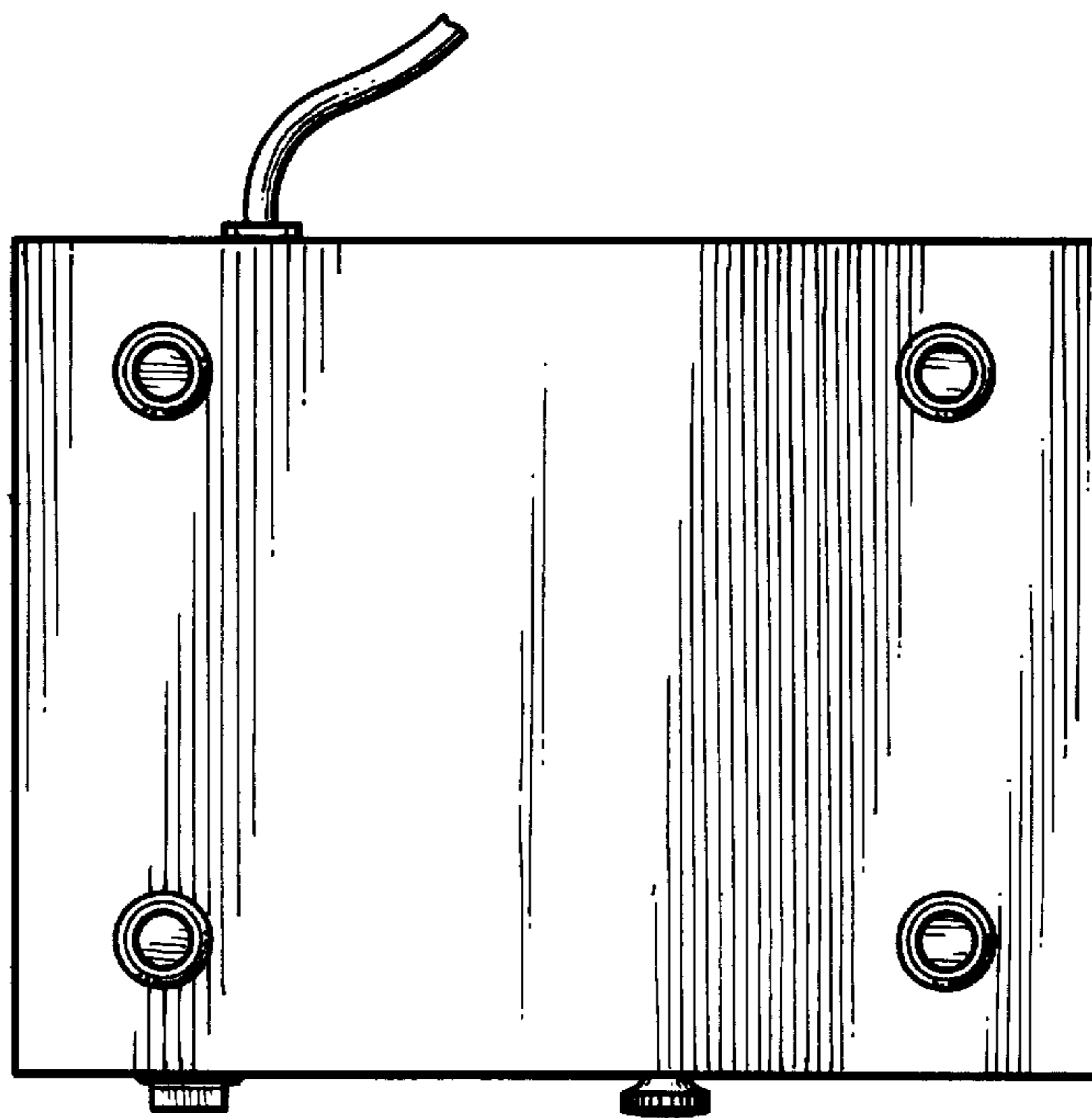

Fig. 7

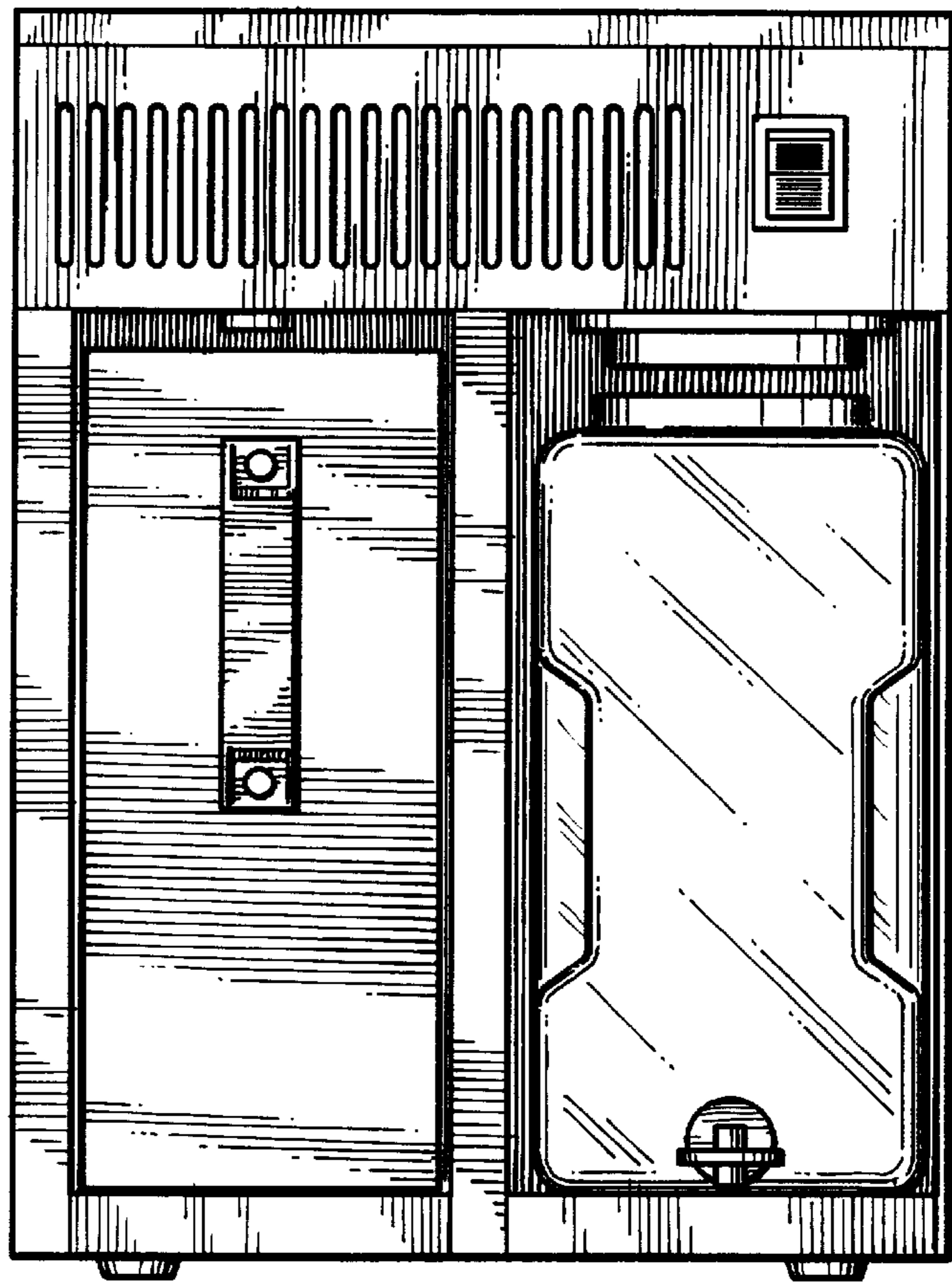

Fig. 9

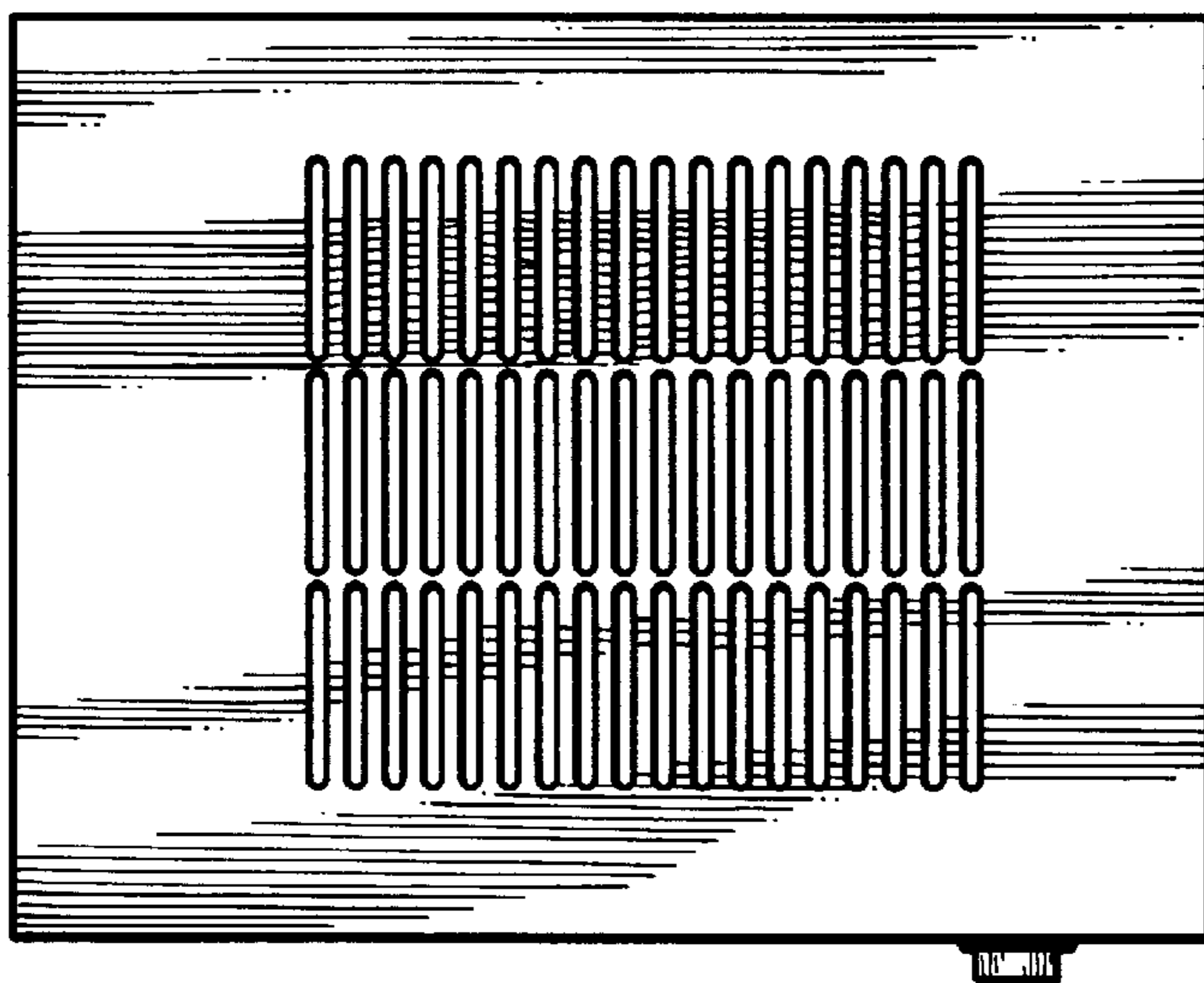

Fig. 10

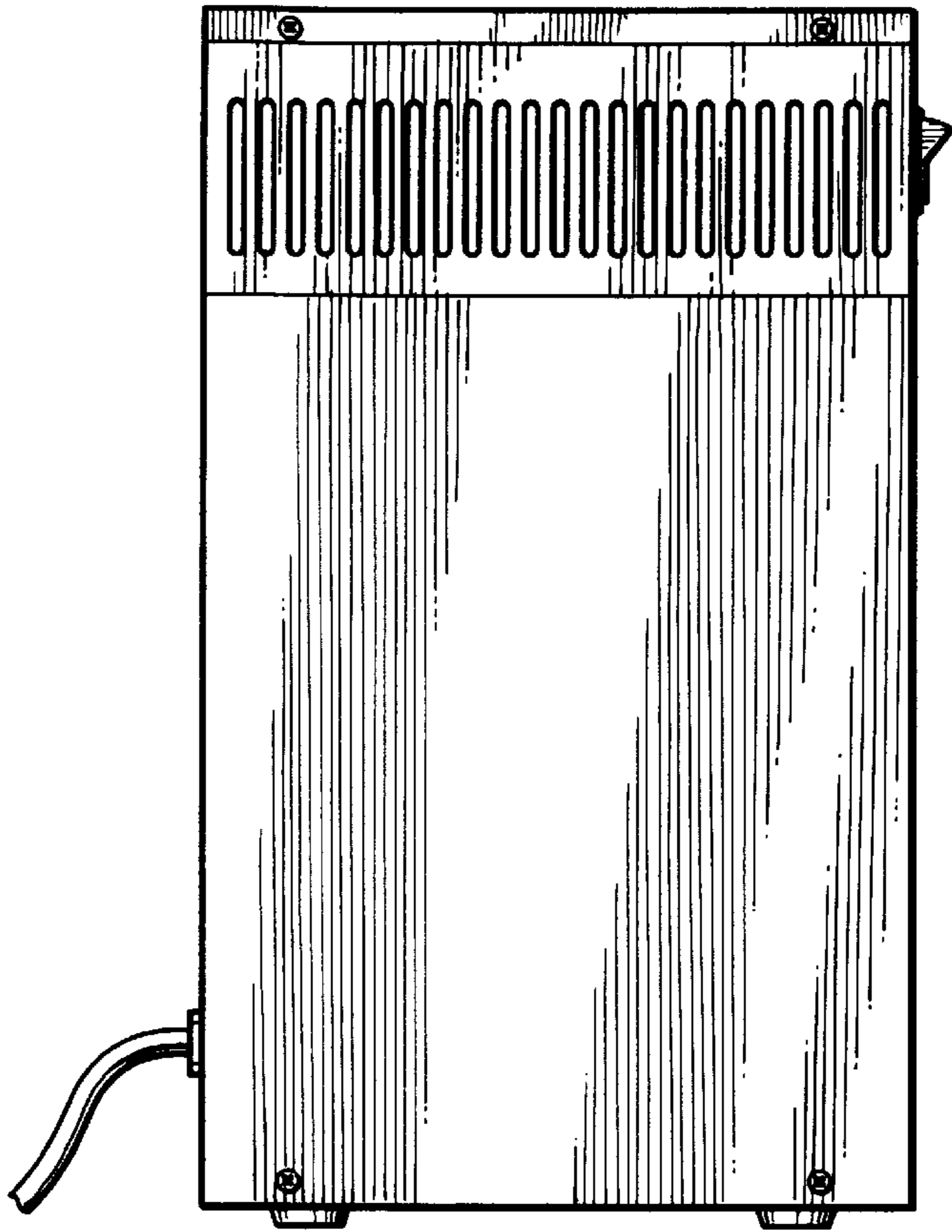

Fig. 11

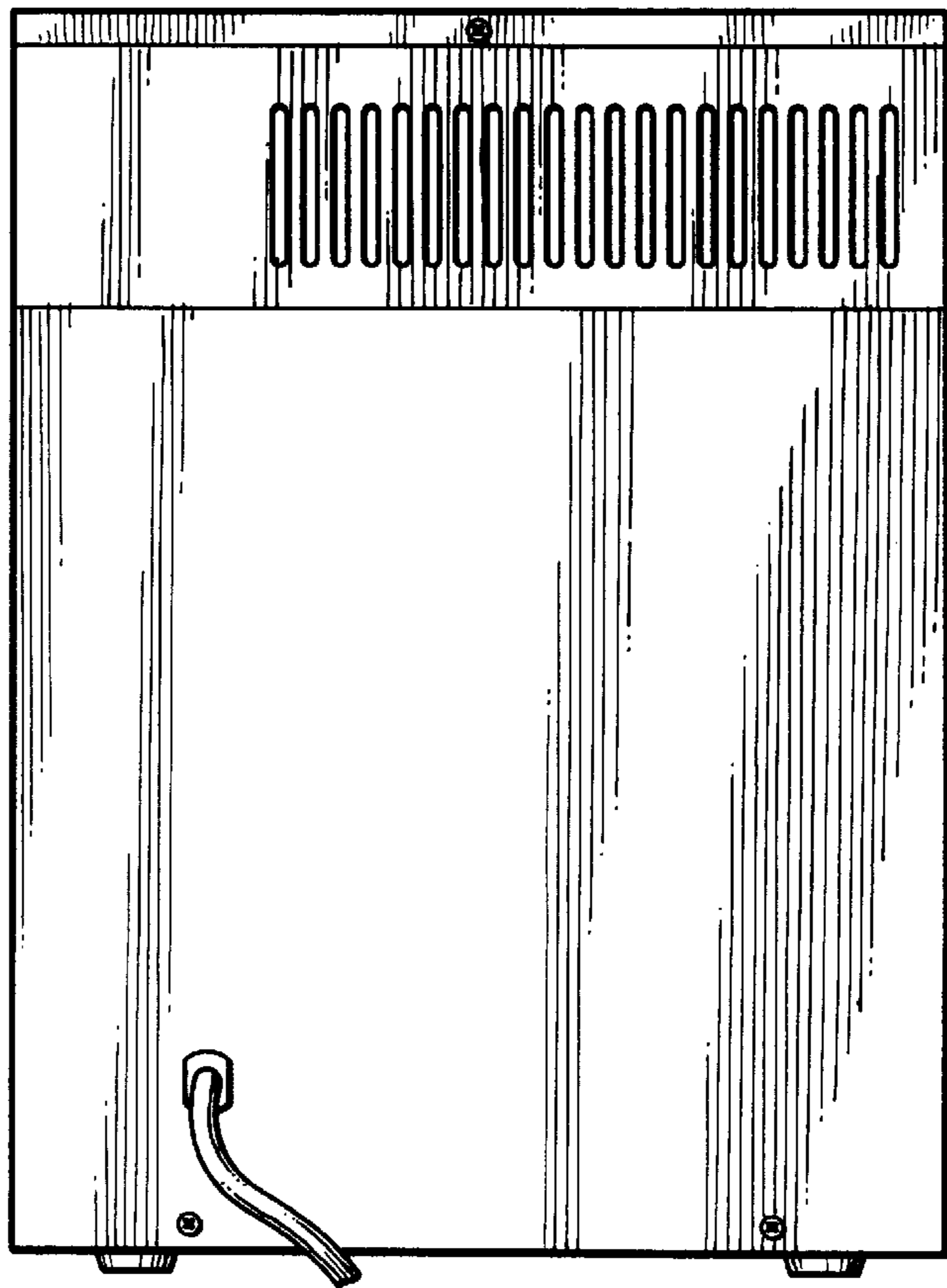

Fig. 12

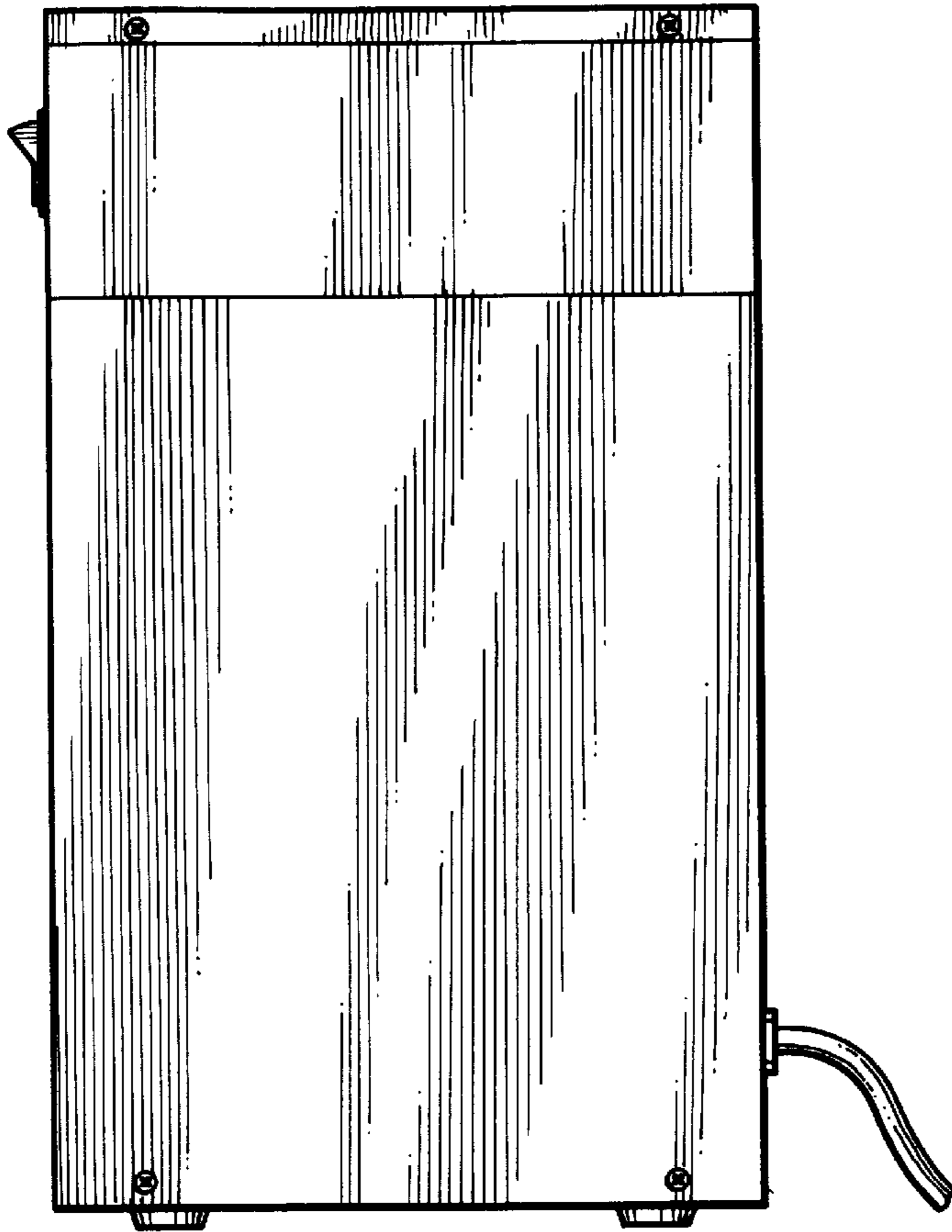

Fig. 13

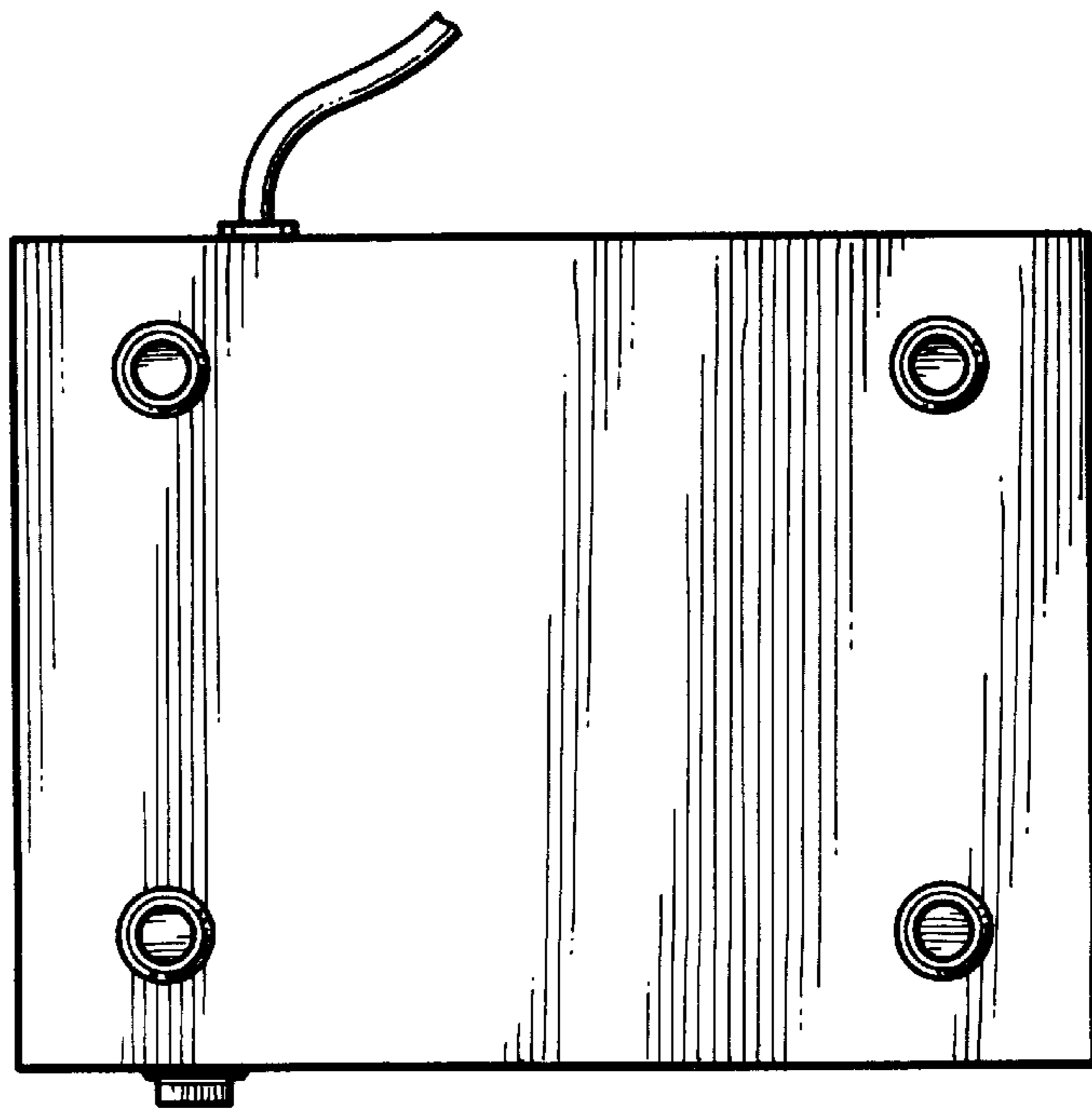

Fig. 14



UNITED STATES PATENT AND TRADEMARK OFFICE  
**CERTIFICATE OF CORRECTION**

PATENT NO. : Des. 412,550  
DATED : August 3, 1999  
INVENTOR(S) : Jeffrey Bell

It is certified that error appears in the above-identified patent and that said Letters Patent is hereby corrected as shown below:

On the title page 1, column 1:

Under section "[56], References Cited,"  
the following U.S. PATENT DOCUMENTS and  
other relevant information is missing:

--	D. 392,368	03/1998	Micoley .....	D23/207
	5,679,274	10/1997	Mahood .....	219/492
	5,609,732	03/1997	Magidson .....	202/83
	4,622,102	11/1986	Diebel .....	202/185.3

Prior art design of water distillation unit on sale more  
than one year before the filing date of this application. --

Signed and Sealed this  
Second Day of May, 2000

Attest:

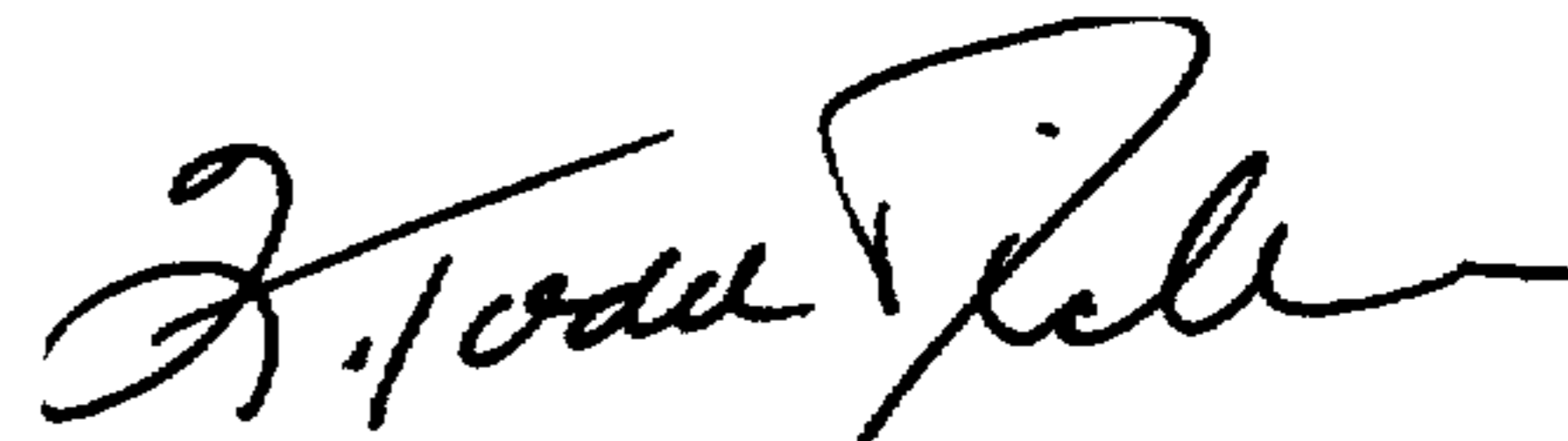

Q. TODD DICKINSON

Attesting Officer

Director of Patents and Trademarks