



US00D412483S

United States Patent [19]

Chintala et al.

[11] **Patent Number: Des. 412,483**

[45] **Date of Patent: ** Aug. 3, 1999**

[54] **BATTERY PACK**

[75] Inventors: **Thomas J. Chintala**, San Diego; **Dawn E. Beattie**, Carlsbad; **Paul E. Jacobs**, La Jolla; **Gina M. Lombardi**; **John E. Maloney**, both of San Diego; **Jeffrey J. Rhine**, Poway; **Stanley T. Scheufler**, Encinitas; **John J. Wendorff**, San Diego, all of Calif.; **Stephen G. Miggels**, Wyckoff; **David C. Stowers**, Nutley, both of N.J.

[73] Assignee: **Qualcomm Incorporated**, San Diego, Calif.

[**] Term: **14 Years**

[21] Appl. No.: **29/078,296**

[22] Filed: **Oct. 24, 1997**

[51] **LOC (6) Cl.** **13-02**

[52] **U.S. Cl.** **D13/103**

[58] **Field of Search** D13/103; 429/96-100, 429/163, 176

[56] **References Cited**

U.S. PATENT DOCUMENTS

D. 350,110	8/1994	Johnson	D13/103
D. 358,128	5/1995	Berry et al.	D13/103
D. 392,939	3/1998	Finke-Anlauff	D13/103
D. 395,277	6/1998	Finke-Anlauff	D13/103

Primary Examiner—Joel Sincavage
Attorney, Agent, or Firm—Russell B. Miller; Charles D. Brown; Roger W. Martin

[57] **CLAIM**

We claim the ornamental design for a battery pack, as shown.

DESCRIPTION

FIG. 1 is a front perspective view; FIG. 2 is a front plan view thereof; FIG. 3 is a left side view thereof; FIG. 4 is a bottom plan view thereof; FIG. 5 is a right side view thereof; FIG. 6 is a back plan view thereof; and, FIG. 7 is a top plan view thereof.

1 Claim, 2 Drawing Sheets

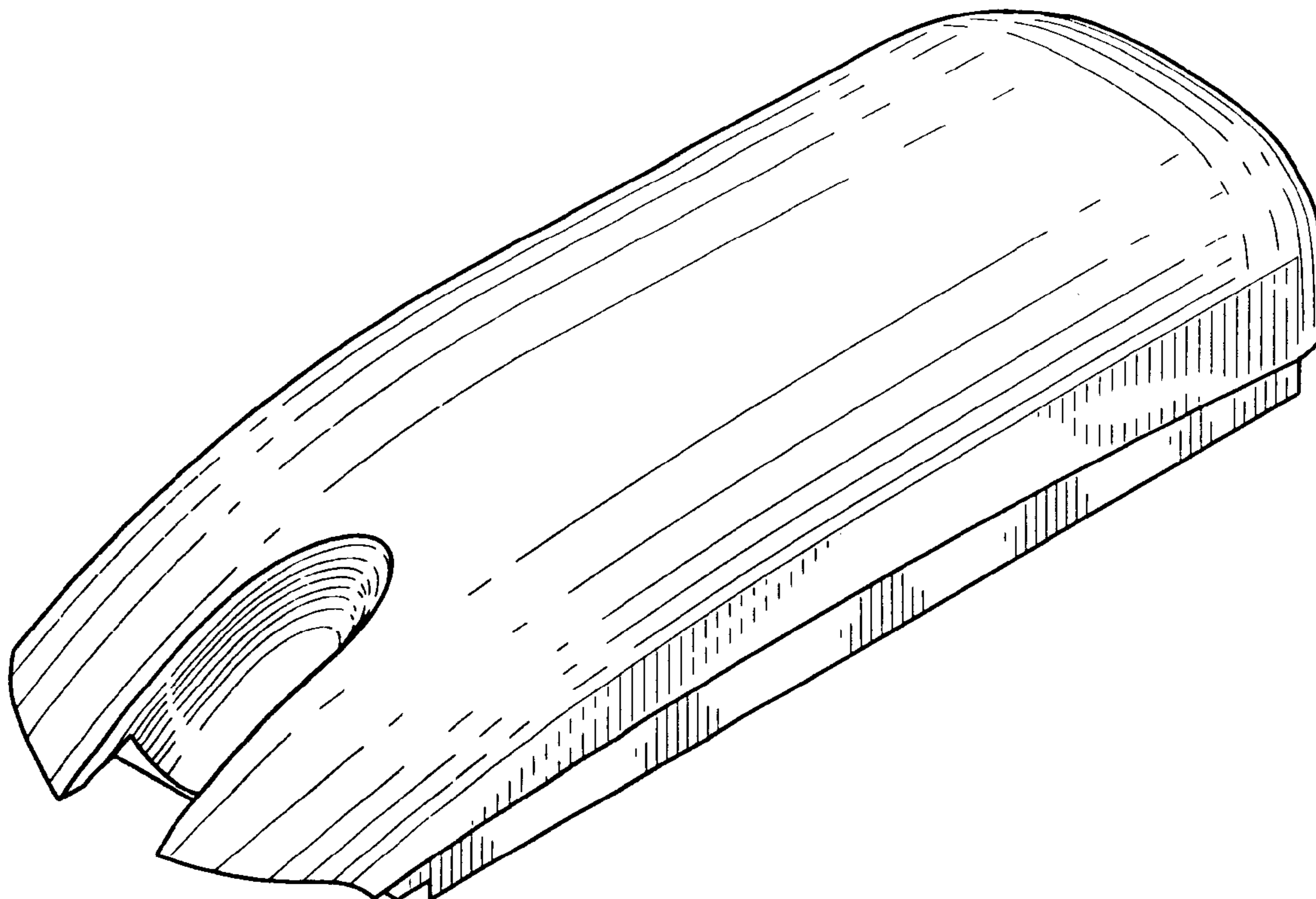

FIG. 1

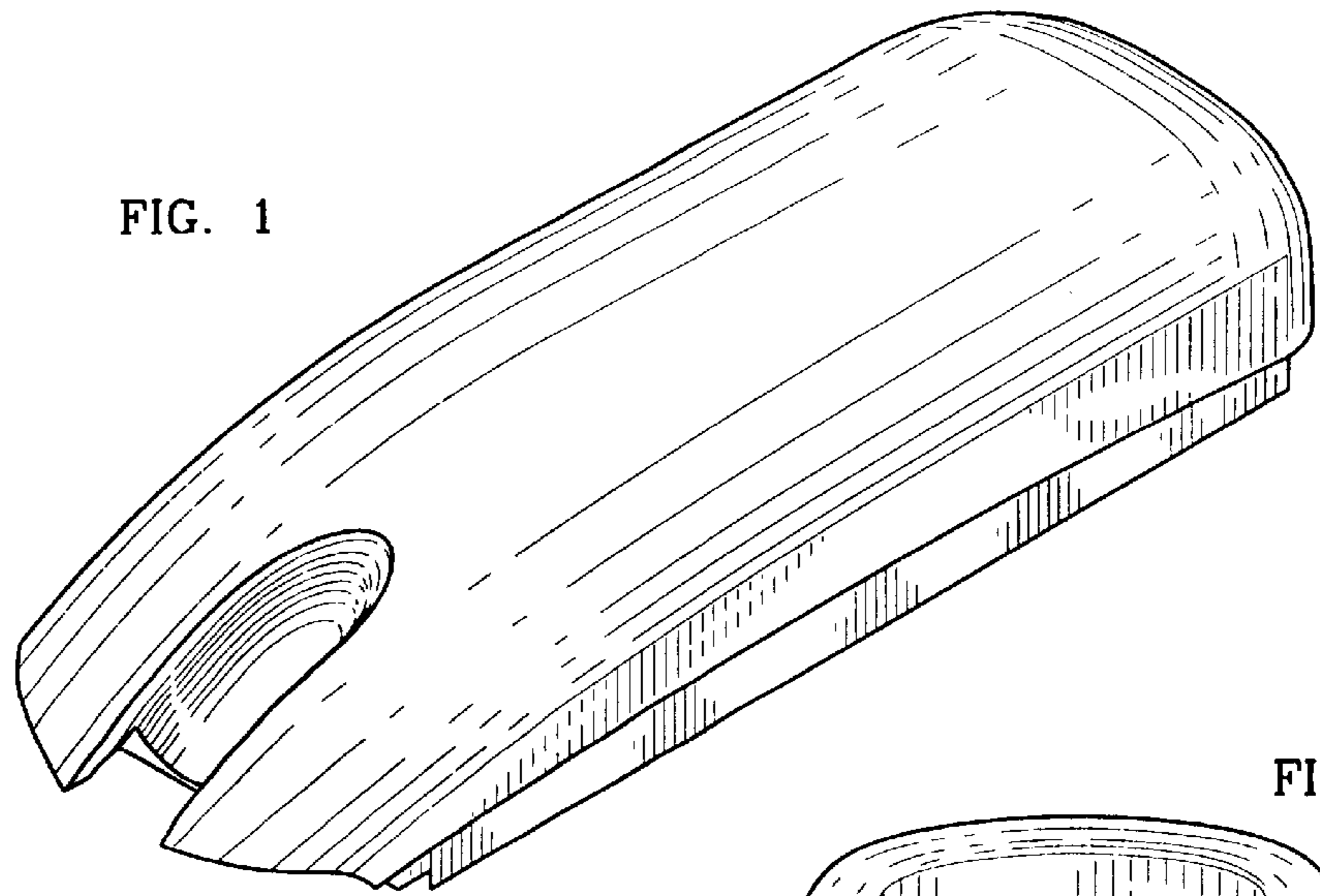

FIG. 4

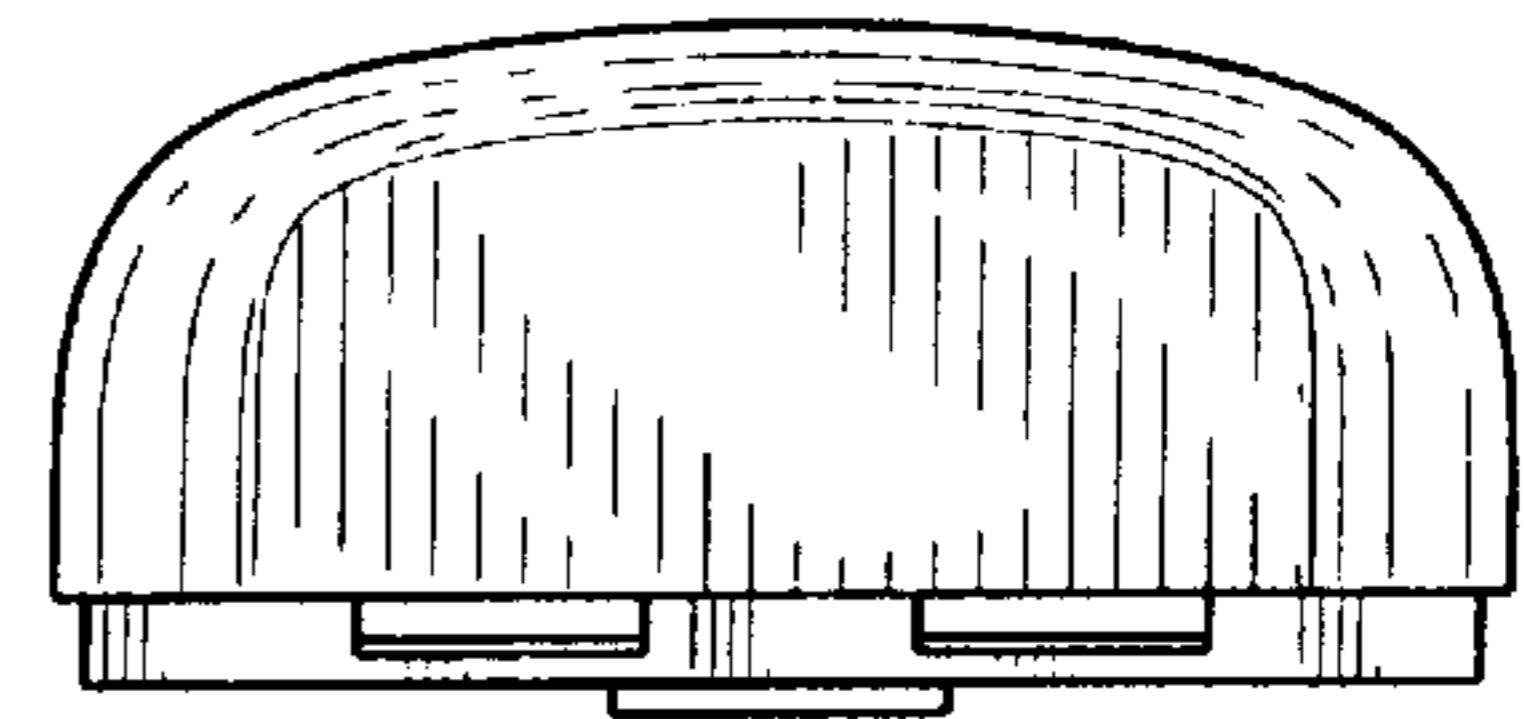

FIG. 2

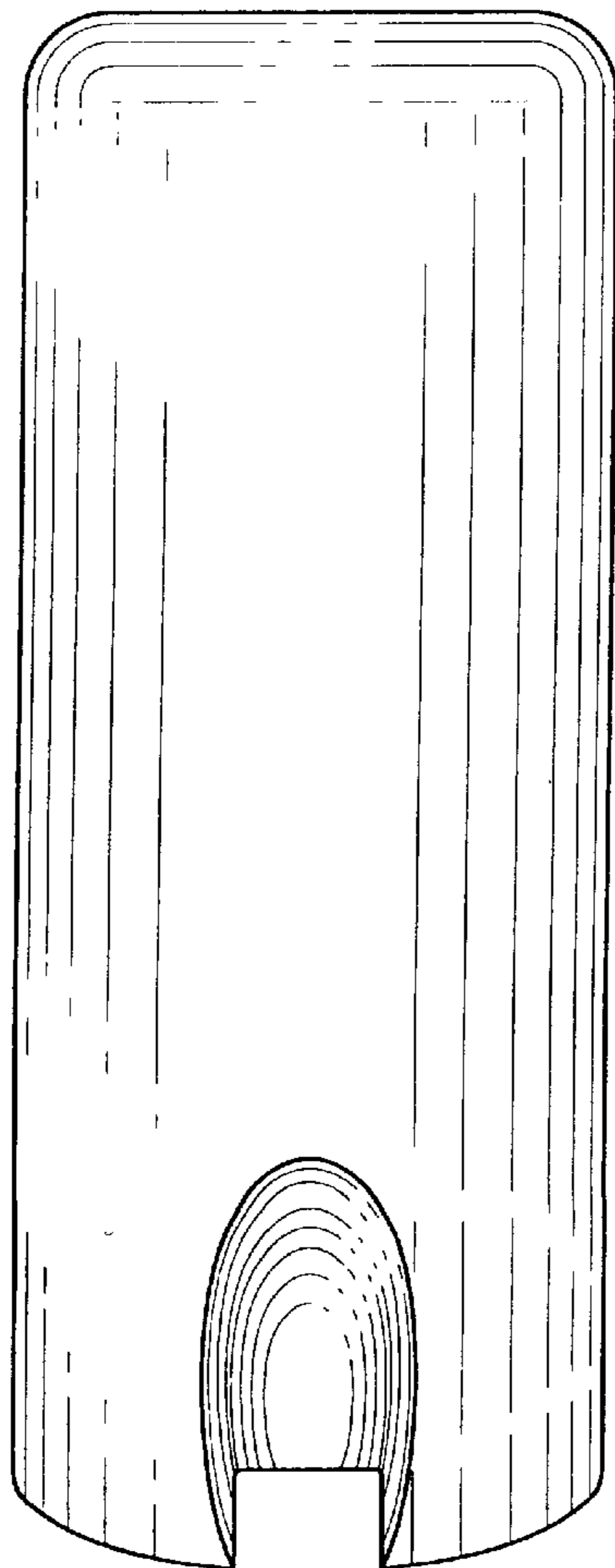

FIG. 3

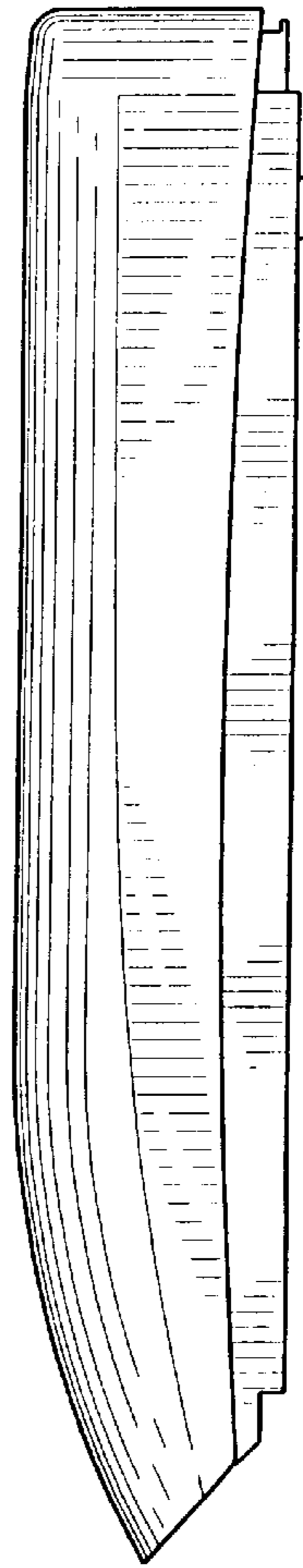

FIG. 6

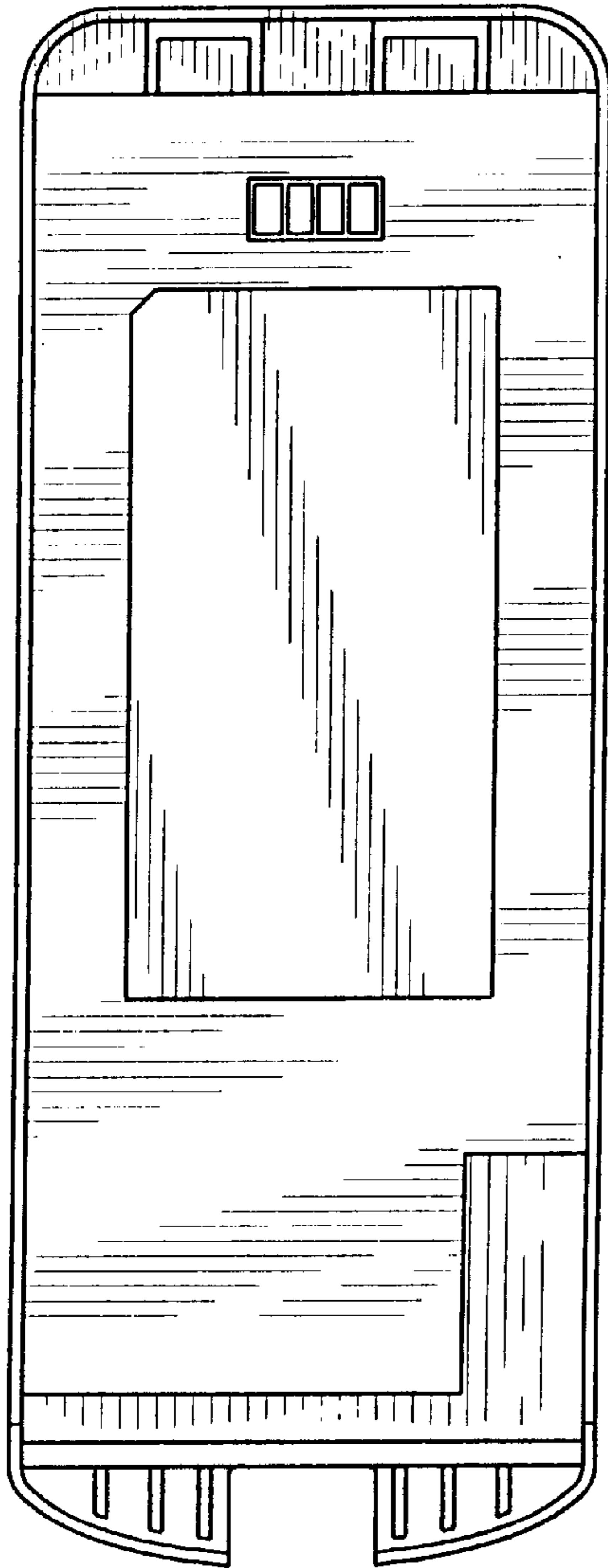

FIG. 5

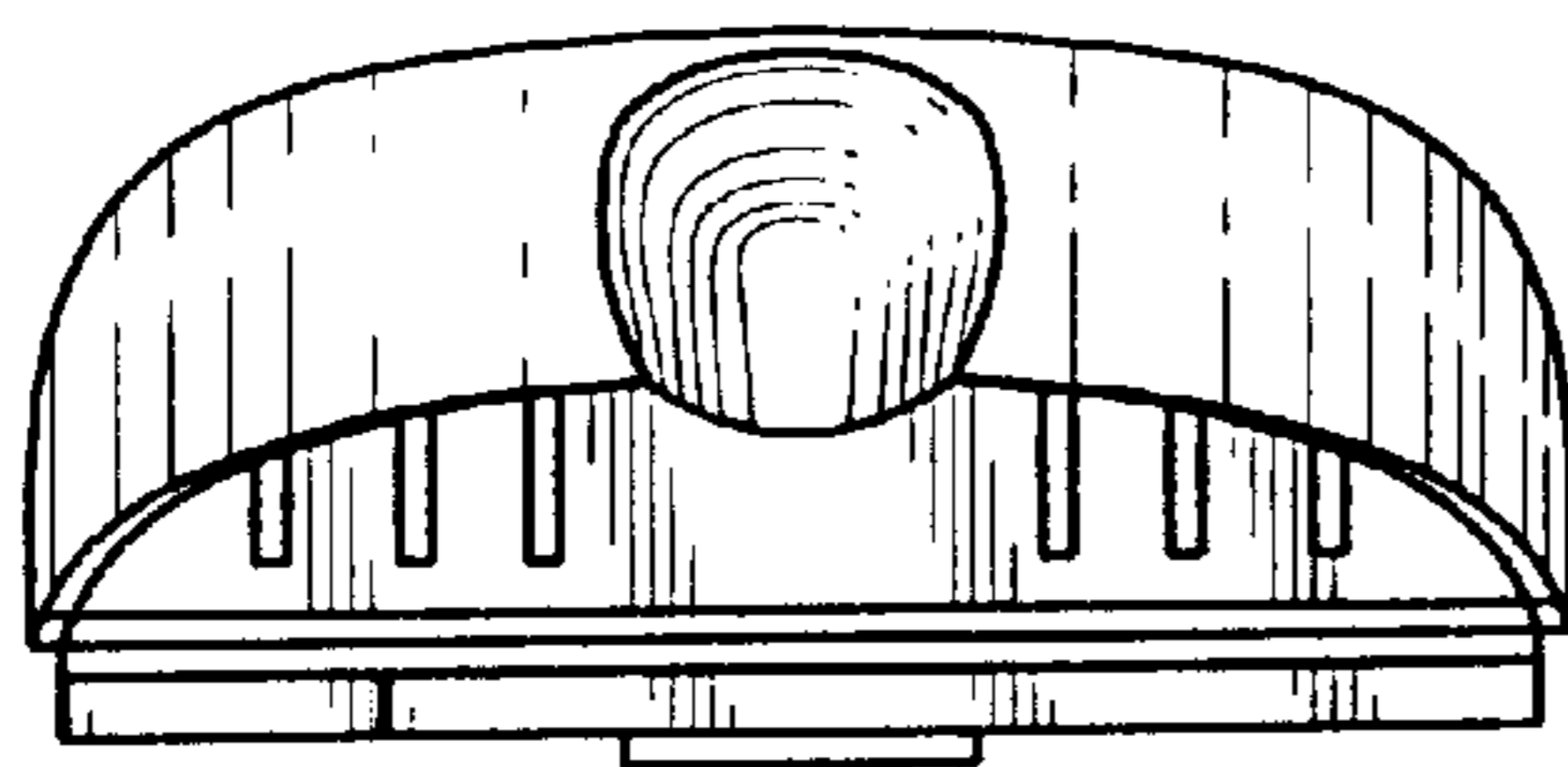
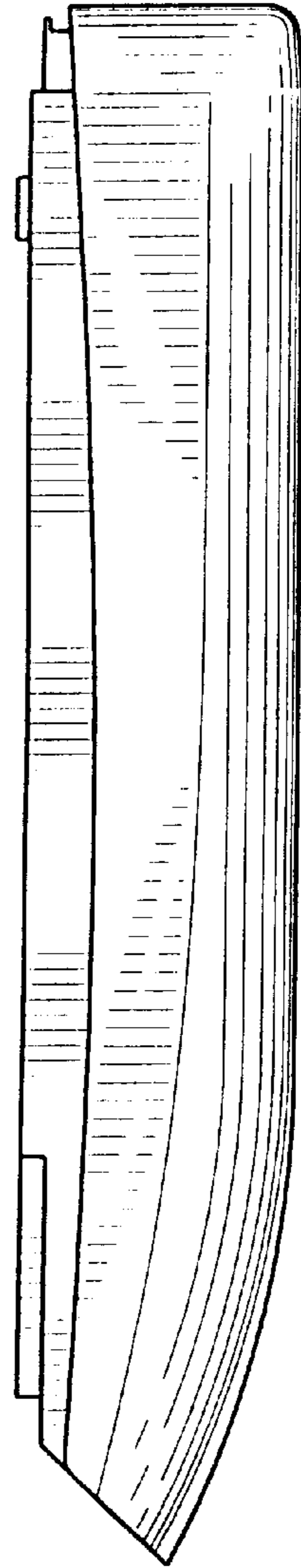

FIG. 7