



US00D412450S

United States Patent [19]
McCain

[11] **Patent Number: Des. 412,450**

[45] **Date of Patent: ** Aug. 3, 1999**

[54] **DIGITAL MULTIMETER**

[75] Inventor: **George L. McCain**, Seattle, Wash.

[73] Assignee: **Fluke Corporation**, Everett, Wash.

[**] Term: **14 Years**

[21] Appl. No.: **29/092,886**

[22] Filed: **Aug. 28, 1998**

[51] **LOC (6) Cl.** **10-04**

[52] **U.S. Cl.** **D10/78**

[58] **Field of Search** D10/78; 324/72.5,
324/110, 114, 115, 149, 151 A, 151 R,
156, 158 F

[56] **References Cited**

U.S. PATENT DOCUMENTS

D. 314,715	2/1991	Nelson et al.	D10/78
D. 332,227	1/1993	Kaneko	D10/78
D. 361,949	9/1995	Kim	D10/78
D. 381,280	7/1997	Tomiyama et al.	D10/78
D. 395,252	6/1998	Nelson et al.	D10/78
5,442,337	8/1995	Hwang	324/115 X
5,619,129	4/1997	Kamiya	324/115

Primary Examiner—Antoine Duval Davis

Attorney, Agent, or Firm—George T. Noe

[57] **CLAIM**

The ornamental design for a digital multimeter, as shown and described.

DESCRIPTION

FIG. 1 is a perspective view of a first embodiment of a digital multimeter showing my new design; FIG. 2 is a front elevation view thereof; FIG. 3 is a right side elevation view thereof; FIG. 4 is a rear elevation view thereof; FIG. 5 is a left side elevation view thereof; FIG. 6 is a top plan view thereof; FIG. 7 is a bottom plan view thereof; FIG. 8 is a perspective view of a second embodiment of a digital multimeter showing my new design; FIG. 9 is a front elevation view thereof; FIG. 10 is a right side elevation view thereof; FIG. 11 is a rear elevation view thereof; FIG. 12 is a left side elevation view thereof; FIG. 13 is a top plan view thereof; and, FIG. 14 is a bottom plan view thereof.

The broken lines showing in FIGS. 1-7 are for illustrative purposes only and forms no part of the claimed design.

1 Claim, 8 Drawing Sheets

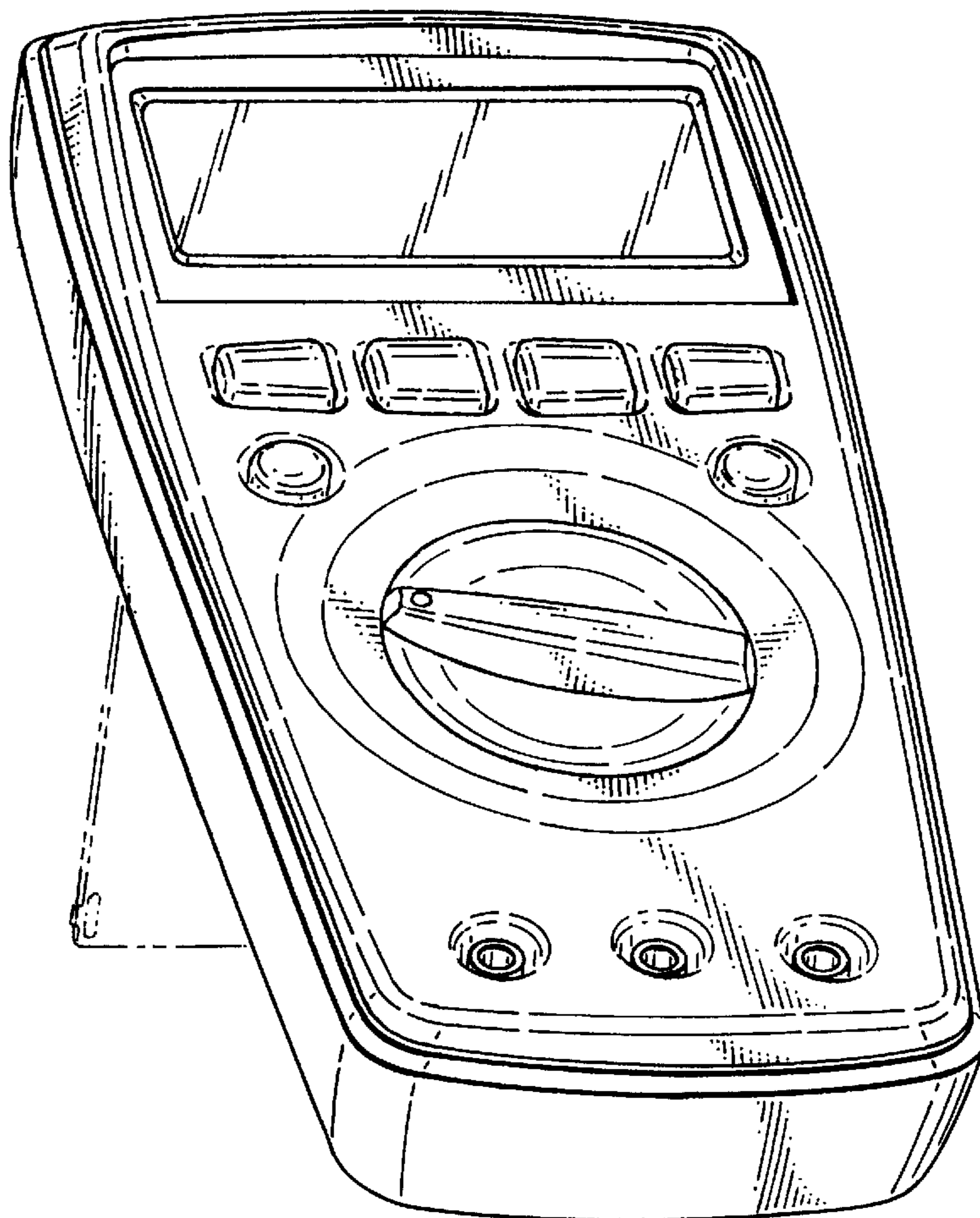

FIG. 1

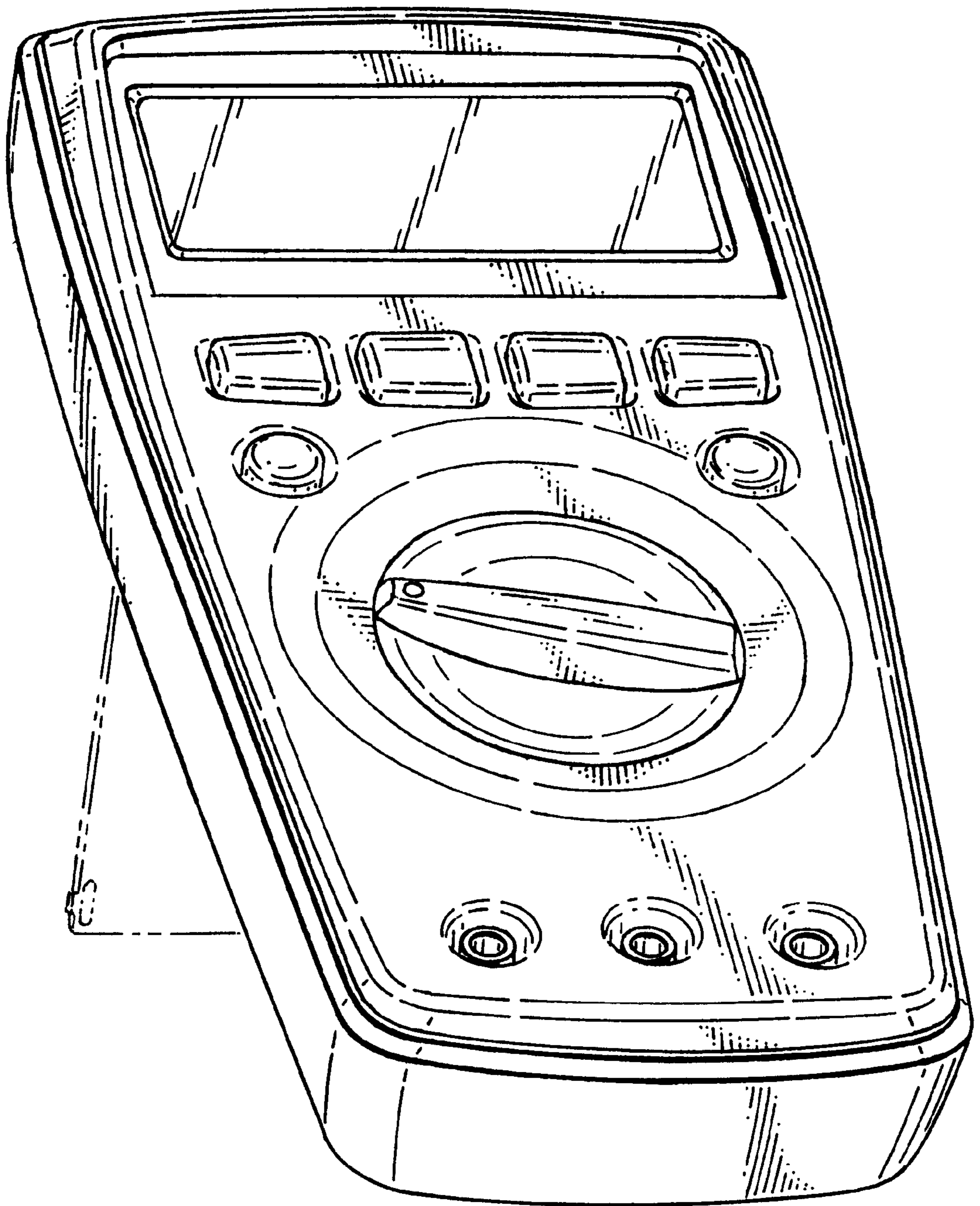

FIG. 2

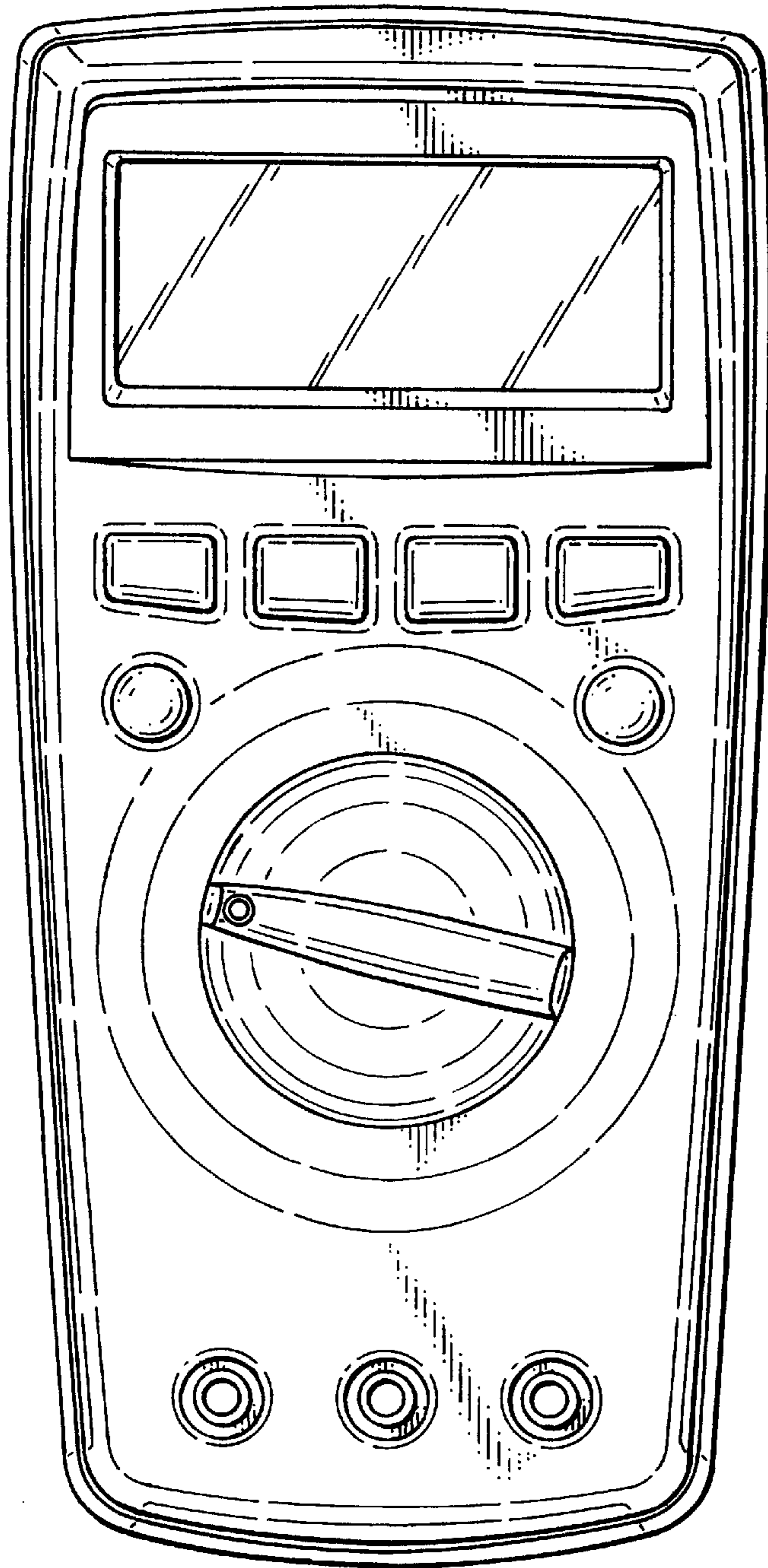

FIG. 3

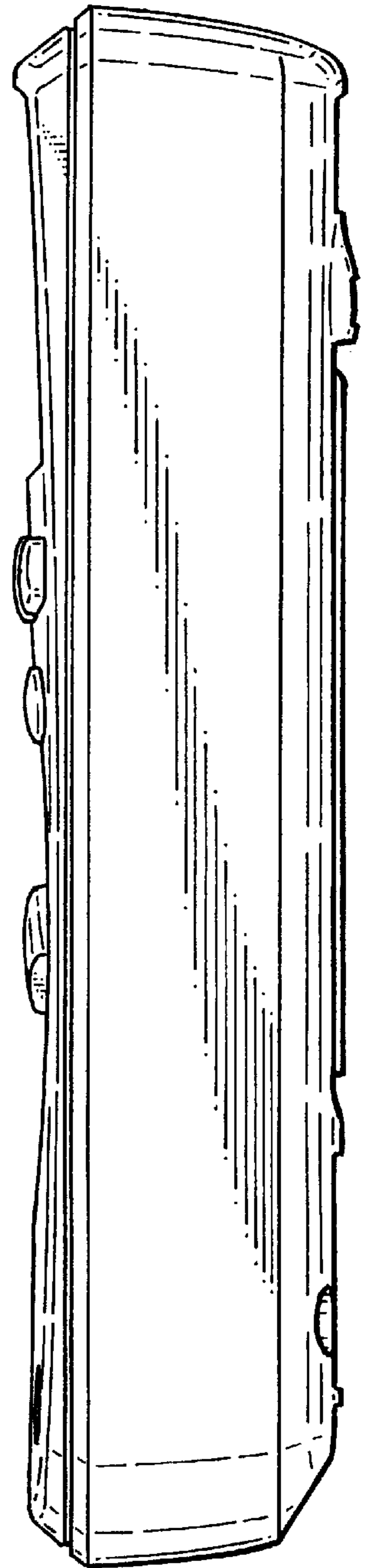

FIG. 4

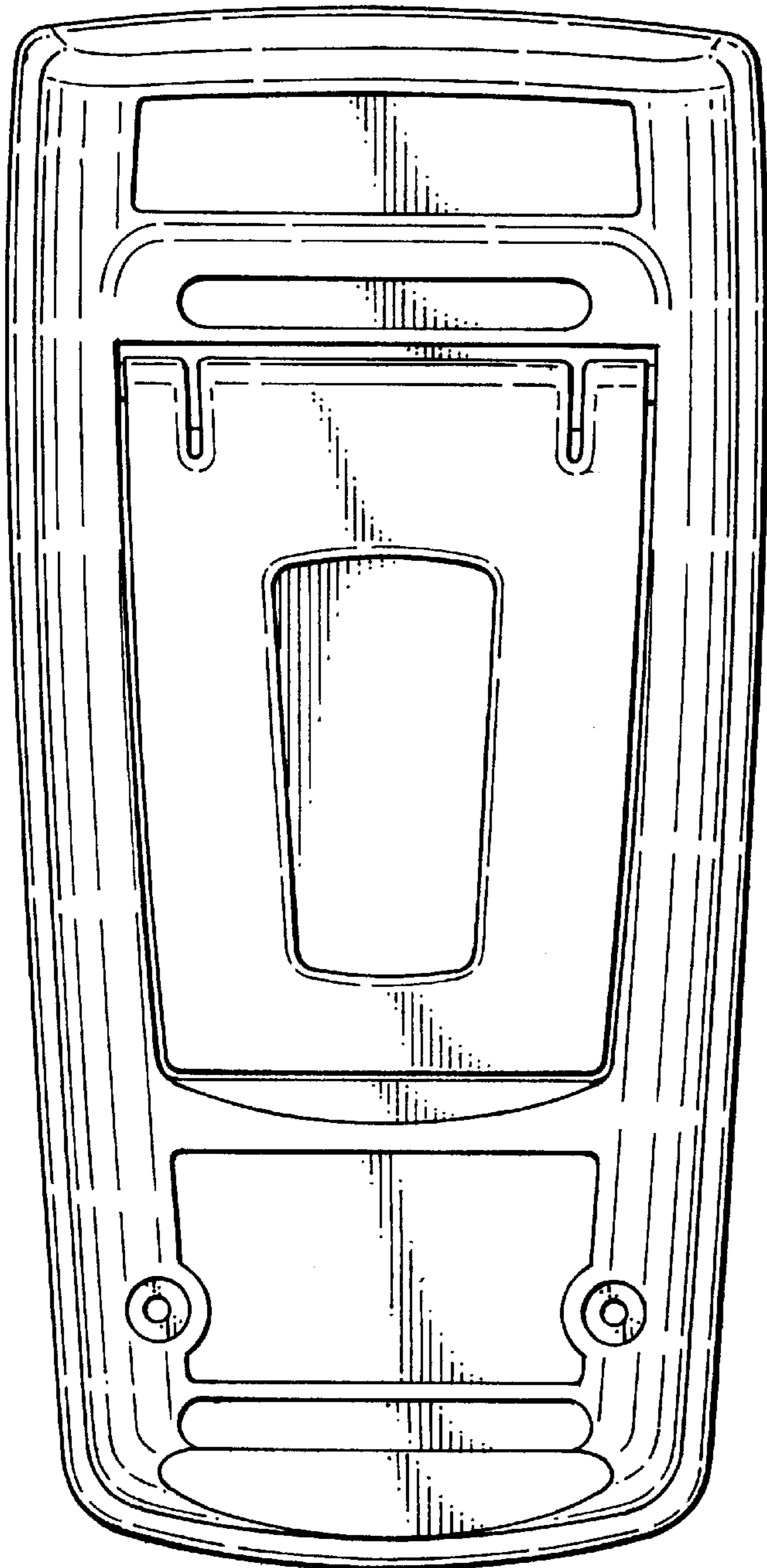

FIG. 5

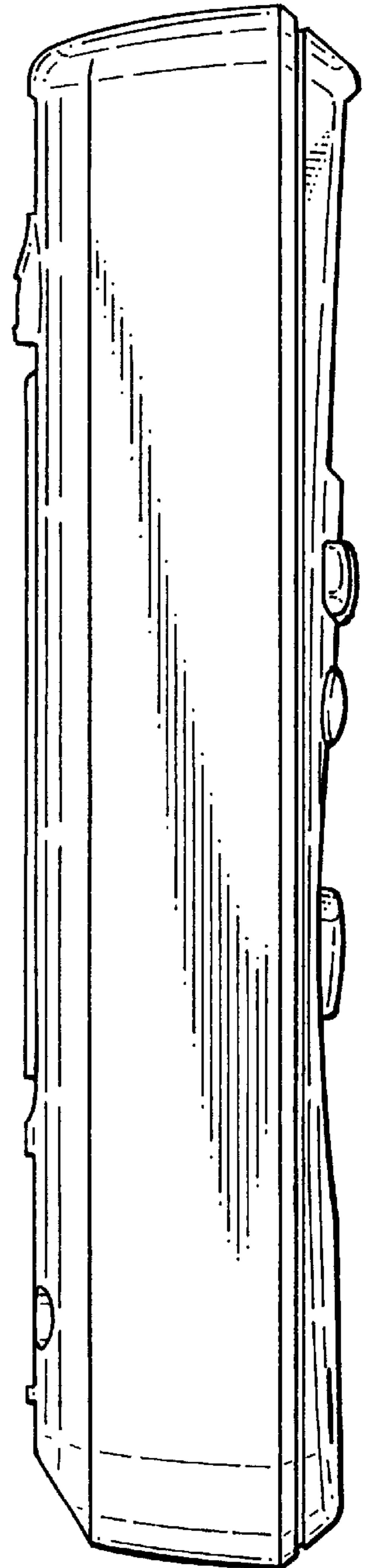

FIG. 6

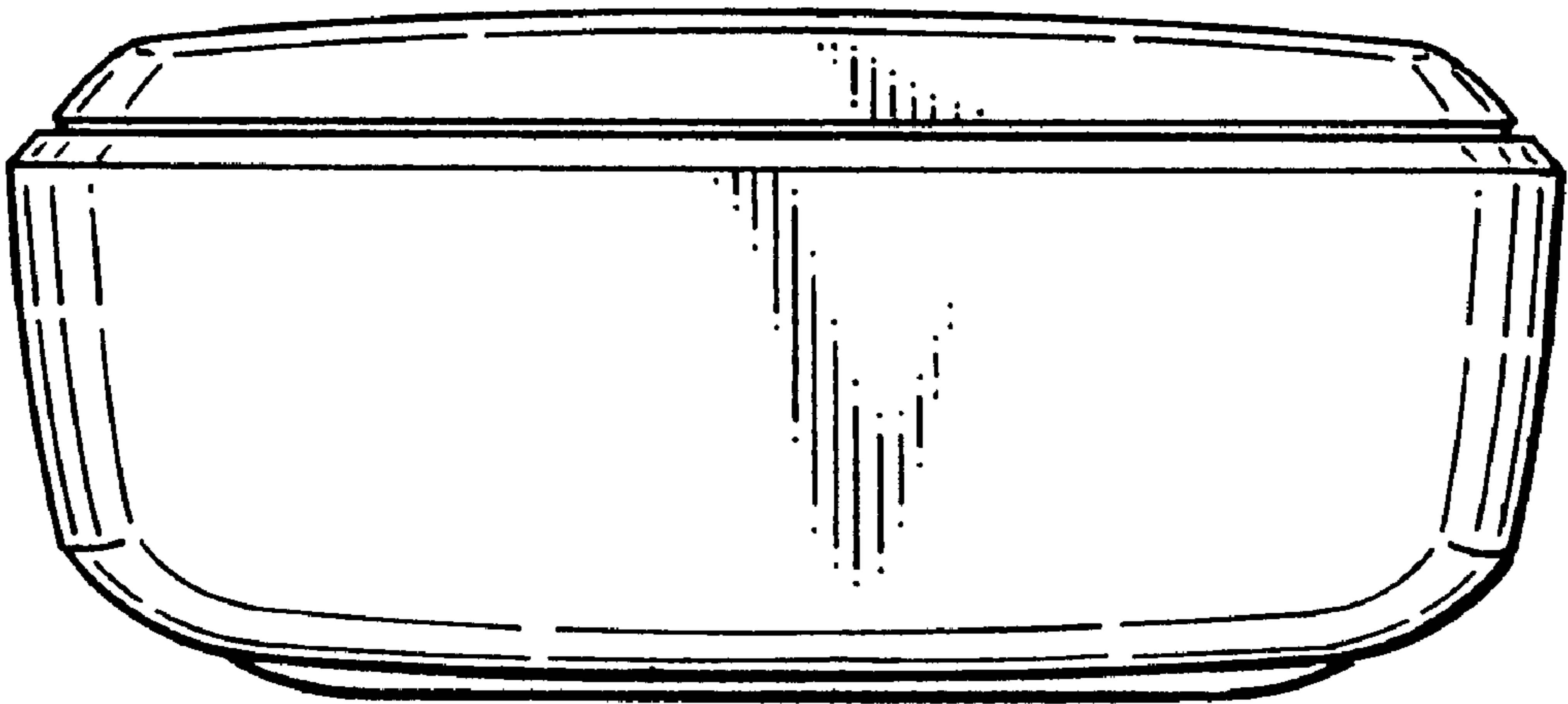

FIG. 7

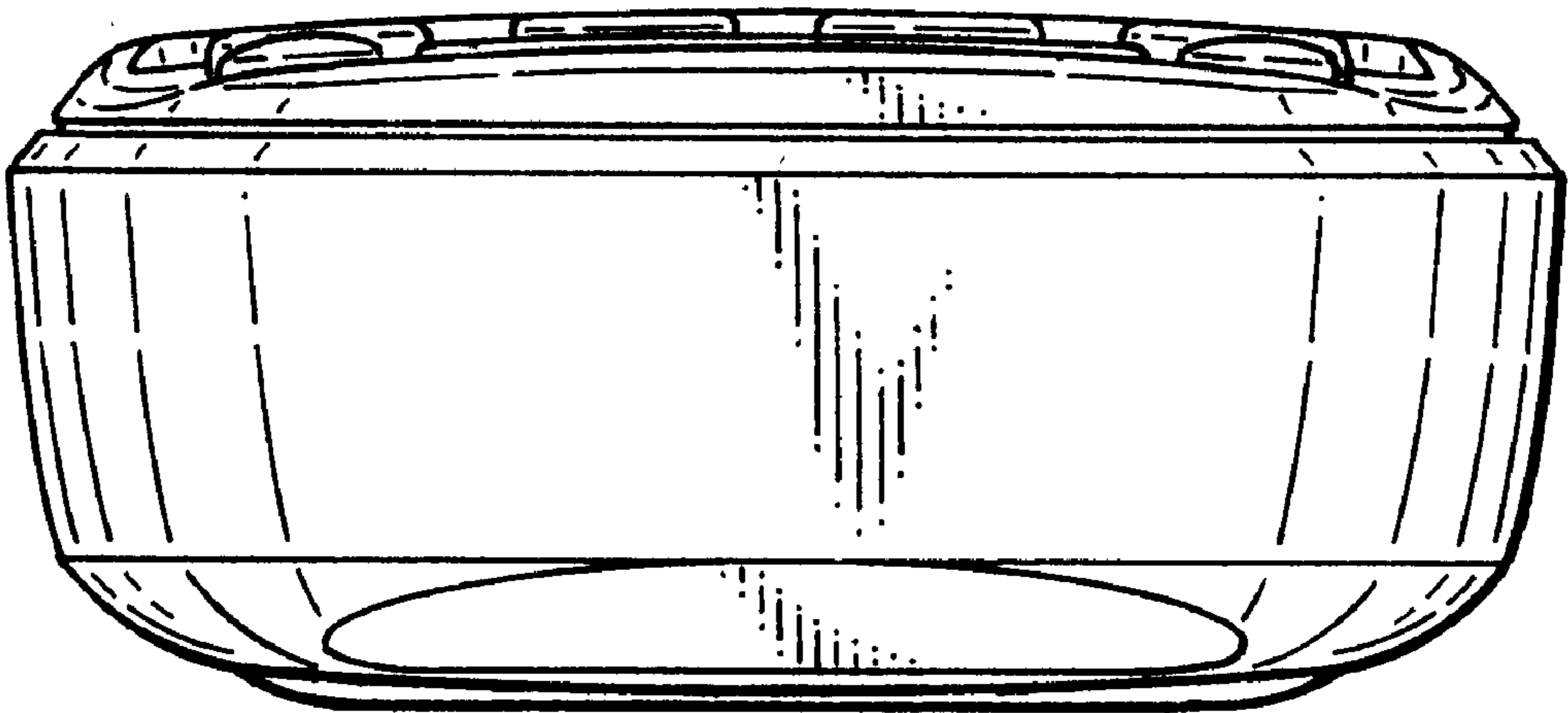

FIG. 8

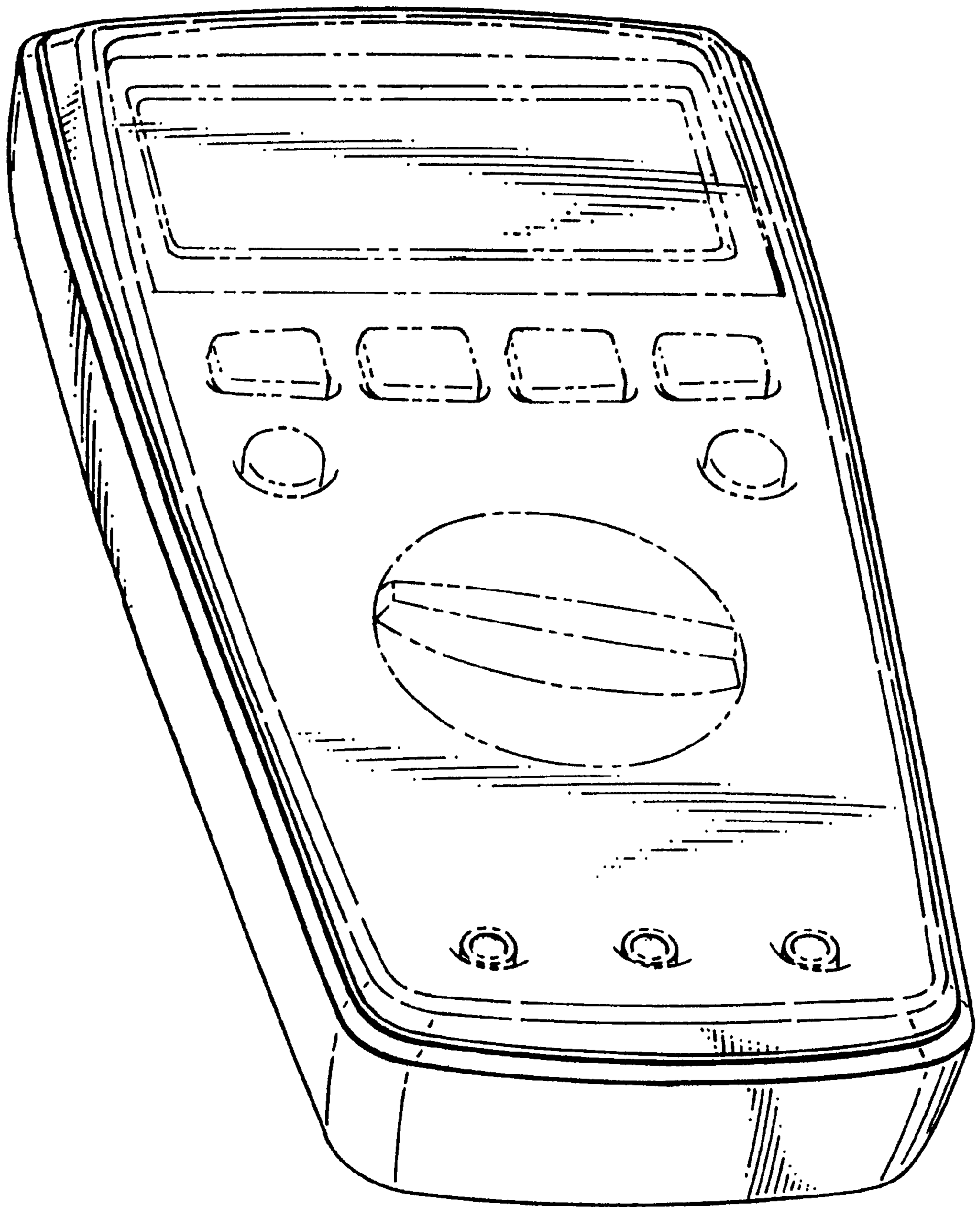

FIG. 9

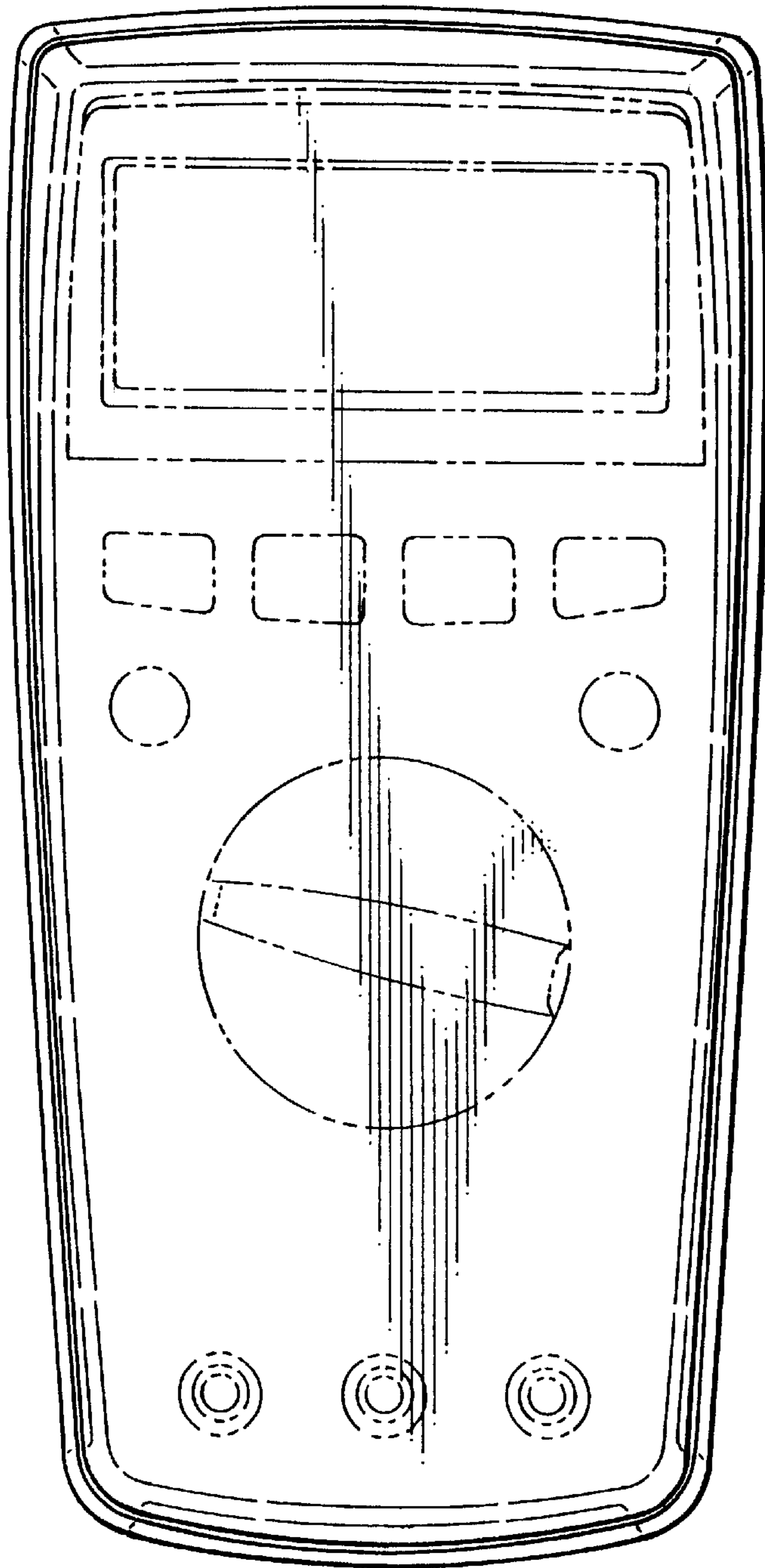

FIG. 10

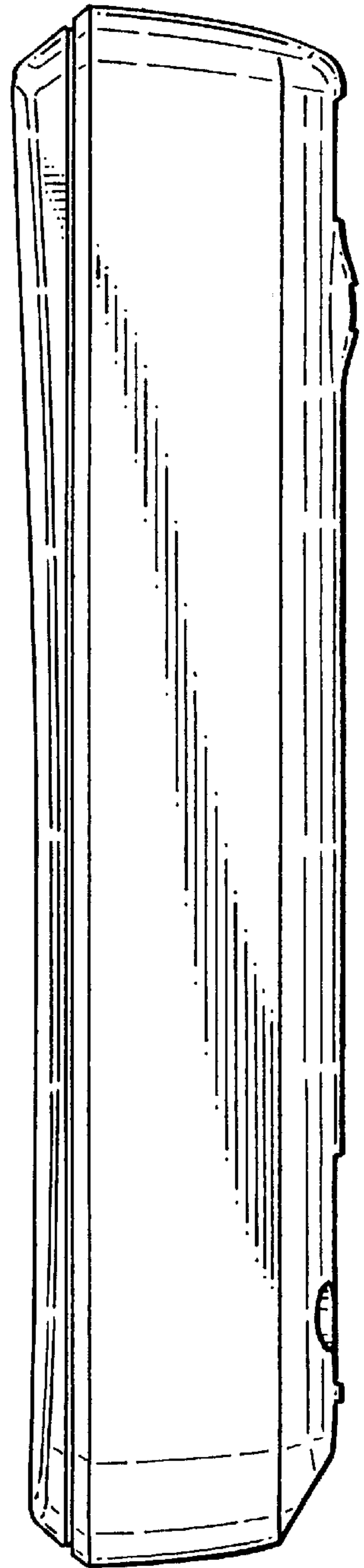

FIG. 11

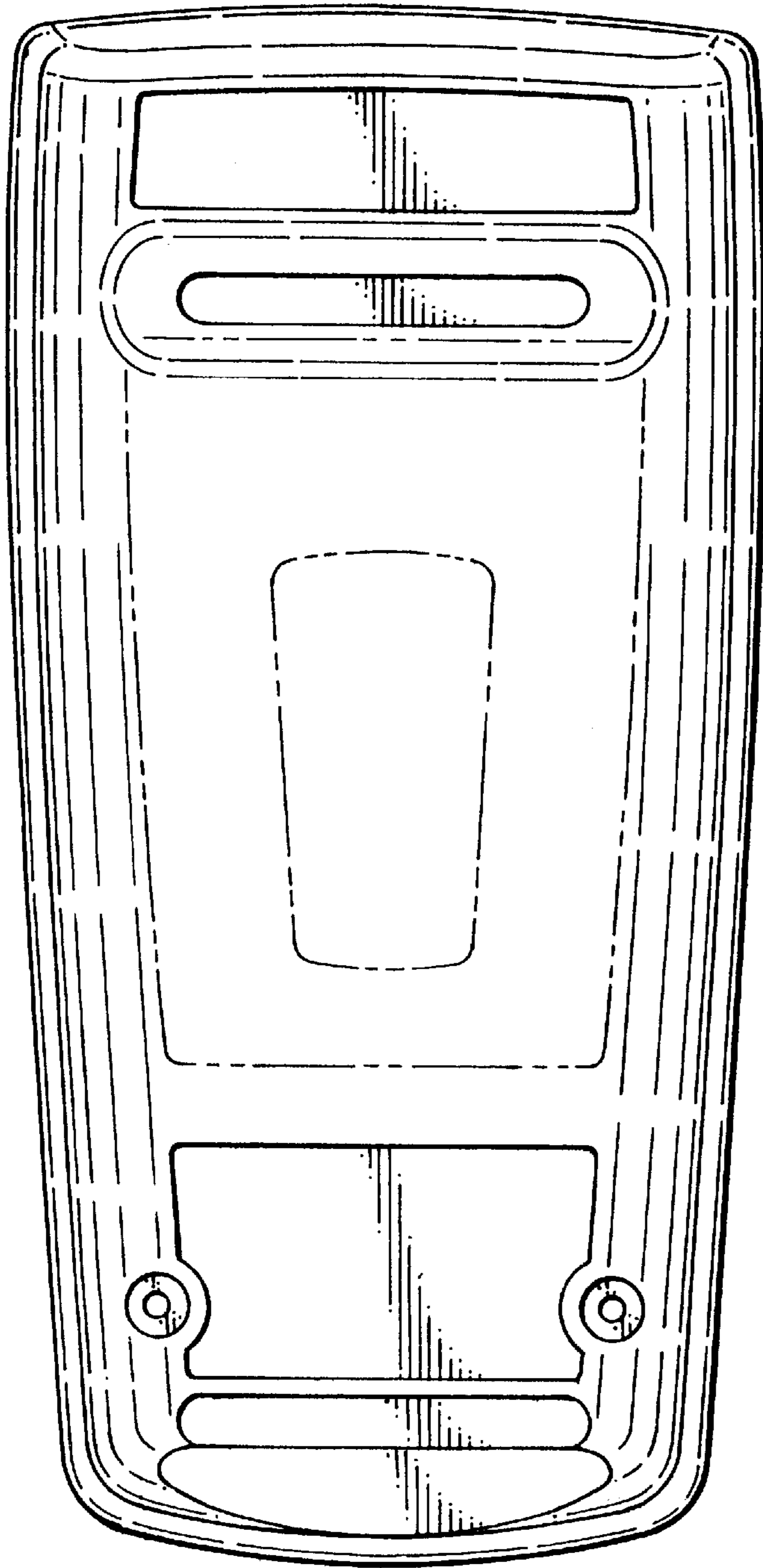

FIG. 12

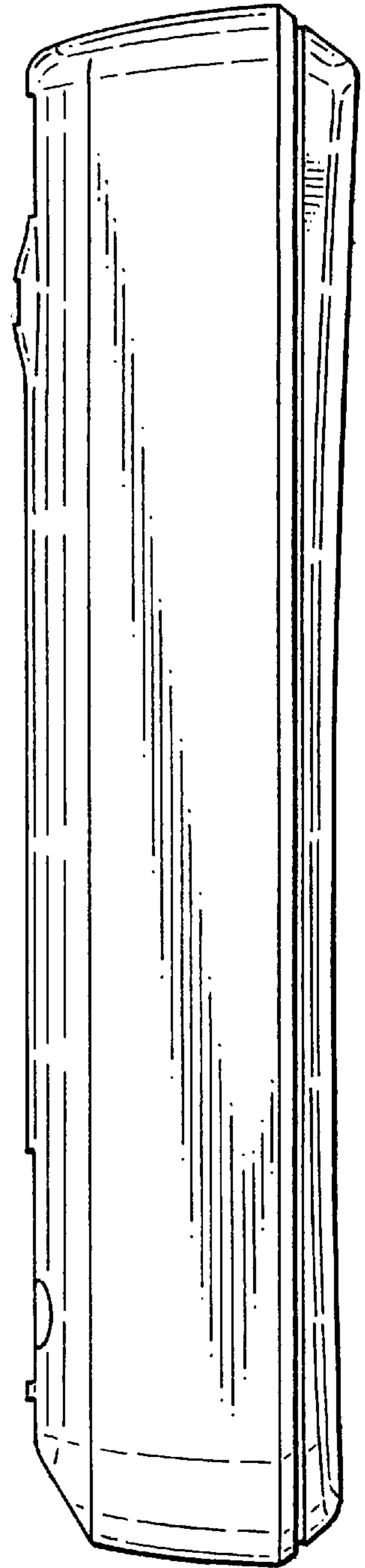

FIG. 13

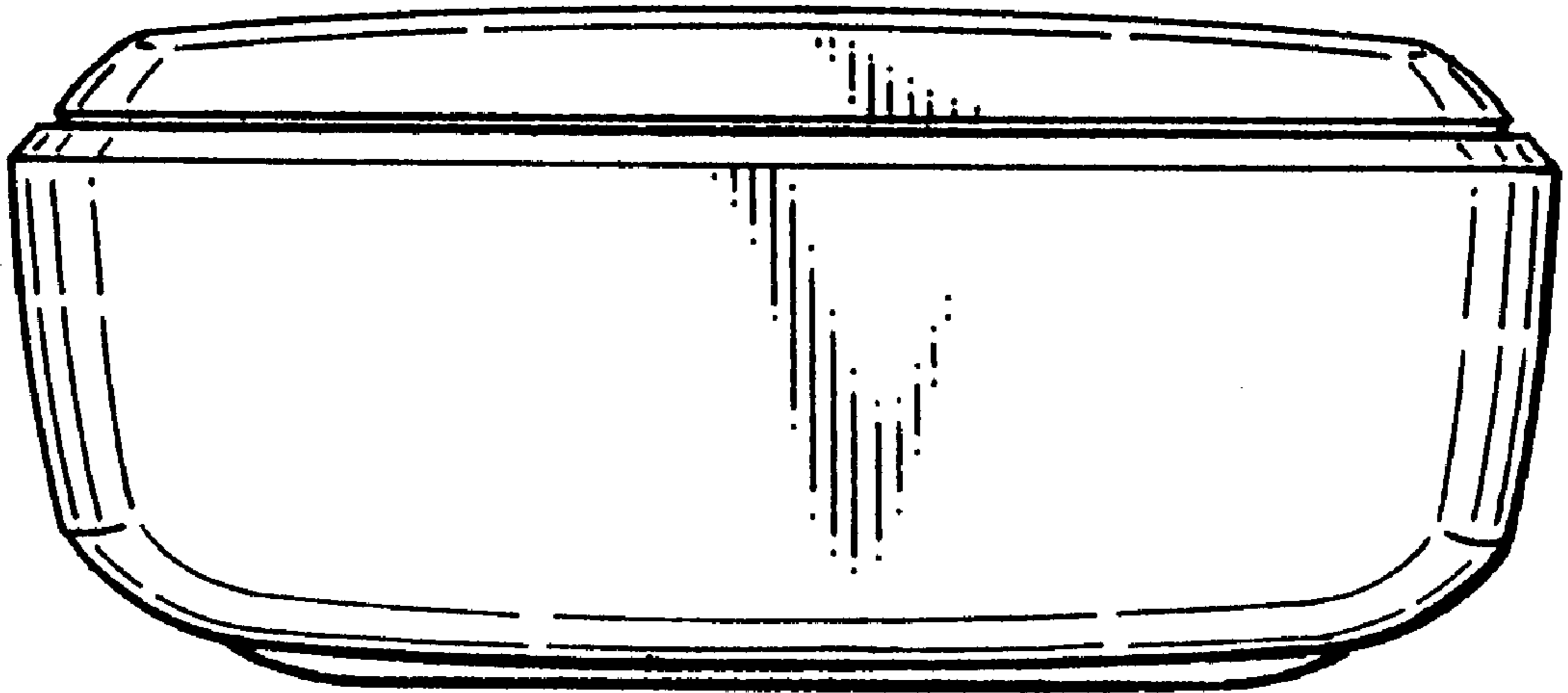

FIG. 14

