



US00D412397S

United States Patent [19]
Liu

[11] **Patent Number: Des. 412,397**

[45] **Date of Patent: ** Aug. 3, 1999**

[54] **PACKING BOX**

[76] Inventor: **Yung-Yuan Liu**, No. 9, Lane 1397,
Kuang Hsing Road, Taiping City,
Taichung Hsien, Taiwan

[**] Term: **14 Years**

[21] Appl. No.: **29/092,381**

[22] Filed: **Aug. 18, 1998**

[51] **LOC (6) Cl.** **03-01**

[52] **U.S. Cl.** **D3/282; D3/276**

[58] **Field of Search** D3/273, 274, 276,
D3/281, 282, 294, 905; 206/349, 372, 373;
190/110, 111, 112, 113

[56] **References Cited**

U.S. PATENT DOCUMENTS

D. 314,669	2/1991	Kunimune	D3/282
D. 321,985	12/1991	Ward	D3/282
D. 328,189	7/1992	Hillinger	D3/282
D. 351,504	10/1994	Tarozzi	D3/273
D. 351,727	10/1994	Tarozzi	D3/282
D. 357,117	4/1995	Huang	D3/282
D. 358,257	5/1995	Sidabras et al.	D3/282

D. 390,358	2/1998	Calmeise	D3/282
D. 399,652	10/1998	Fang	D3/282

Primary Examiner—Philip S. Hyder
Attorney, Agent, or Firm—Rosenberg, Klein & Bilker

[57] **CLAIM**

The ornamental design for packing box, as shown and described.

DESCRIPTION

FIG. 1 is a front view of a packing box showing my present design;
FIG. 2 is a rear view thereof;
FIG. 3 is a top plan view thereof;
FIG. 4 is a bottom plan view thereof;
FIG. 5 is a left view thereof;
FIG. 6 is a right view thereof;
FIG. 7 is a perspective view thereof;
FIG. 8 is a front view of the open status thereof;
FIG. 9 is a rear view of the open status thereof;
FIG. 10 is a top plan view of the open status thereof;
FIG. 11 is a bottom plan view of the open status thereof;
FIG. 12 is a left view of the open status thereof; and,
FIG. 13 is a right view of the open status.

1 Claim, 8 Drawing Sheets

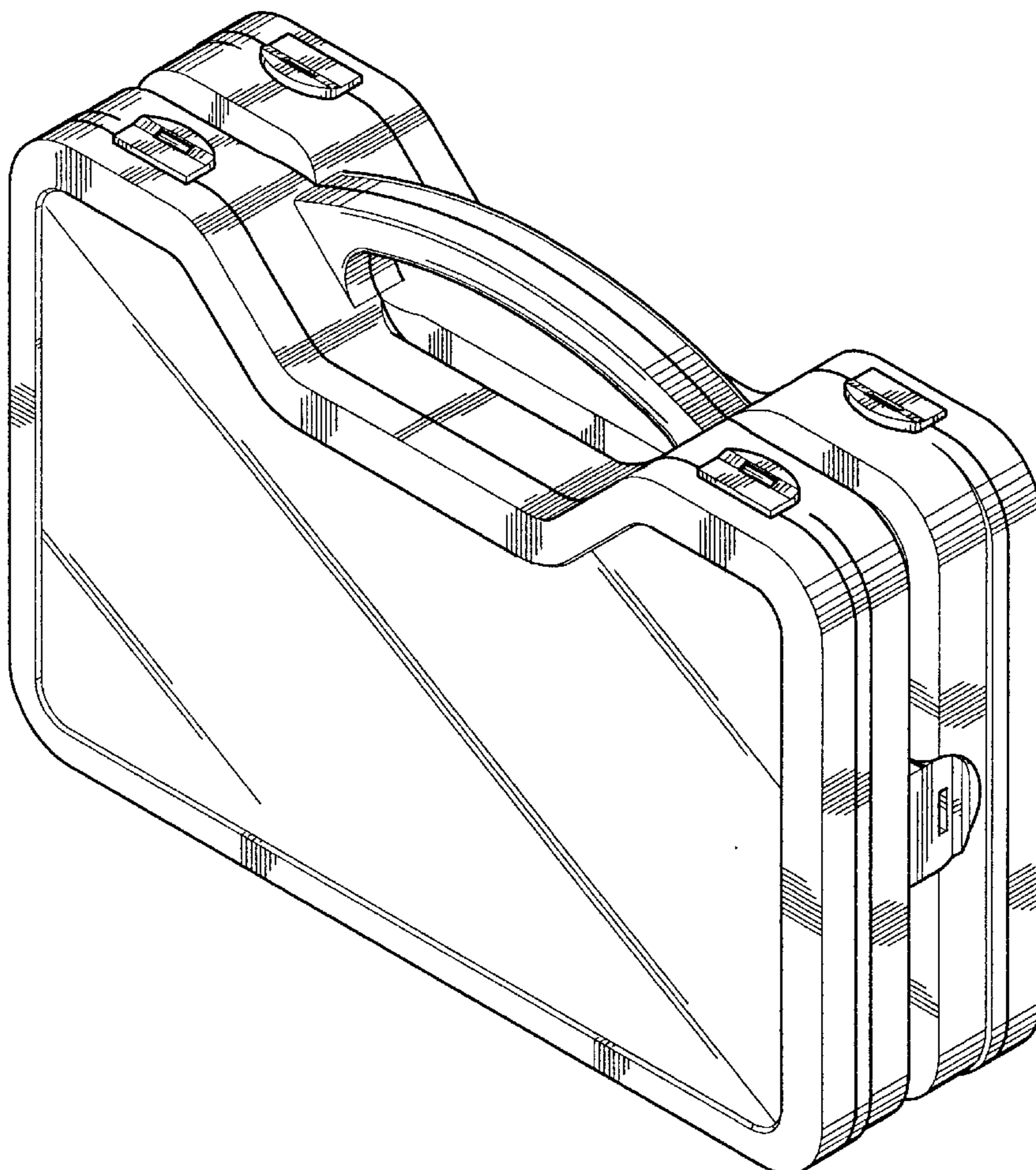

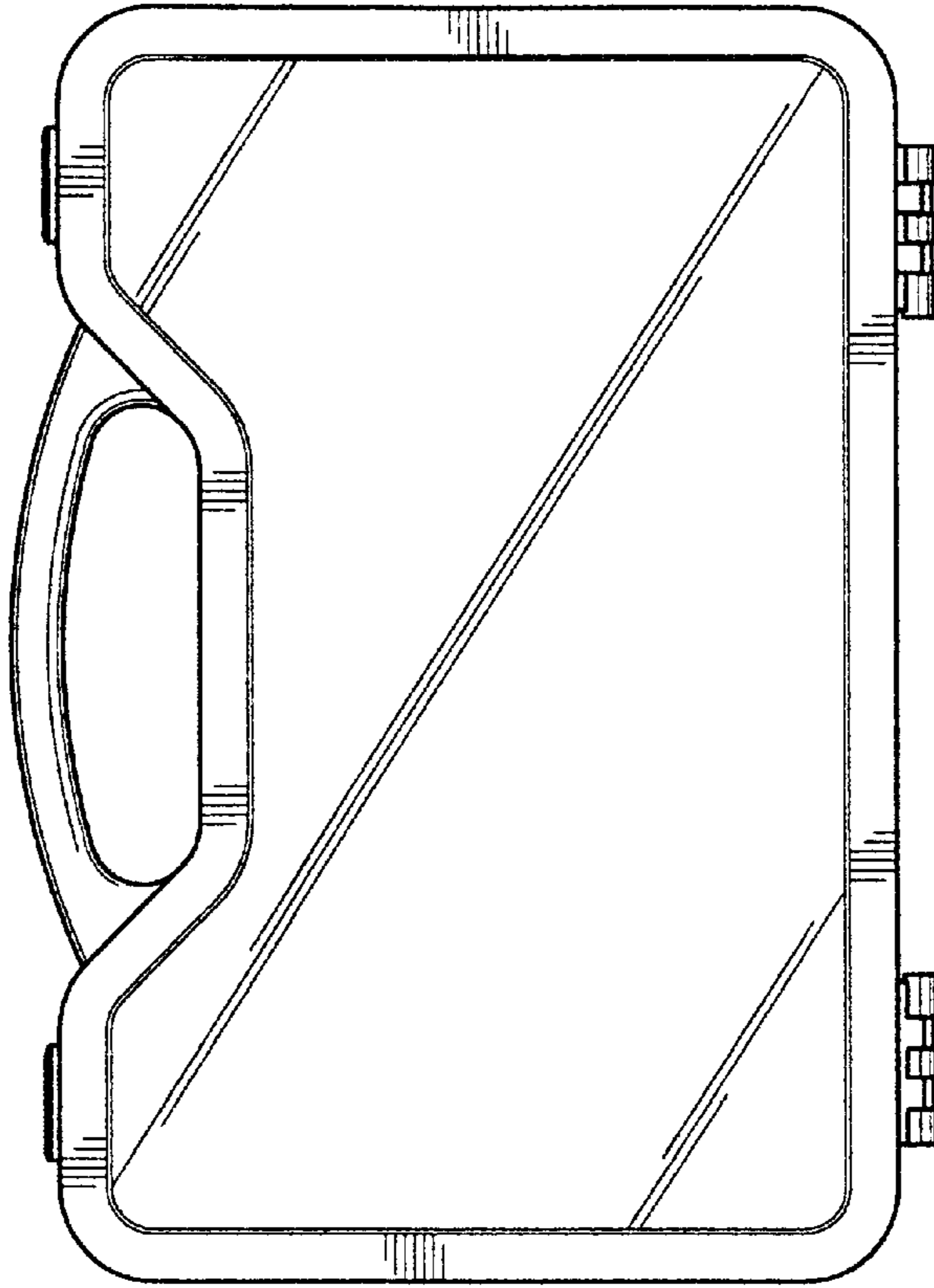

Fig. 2

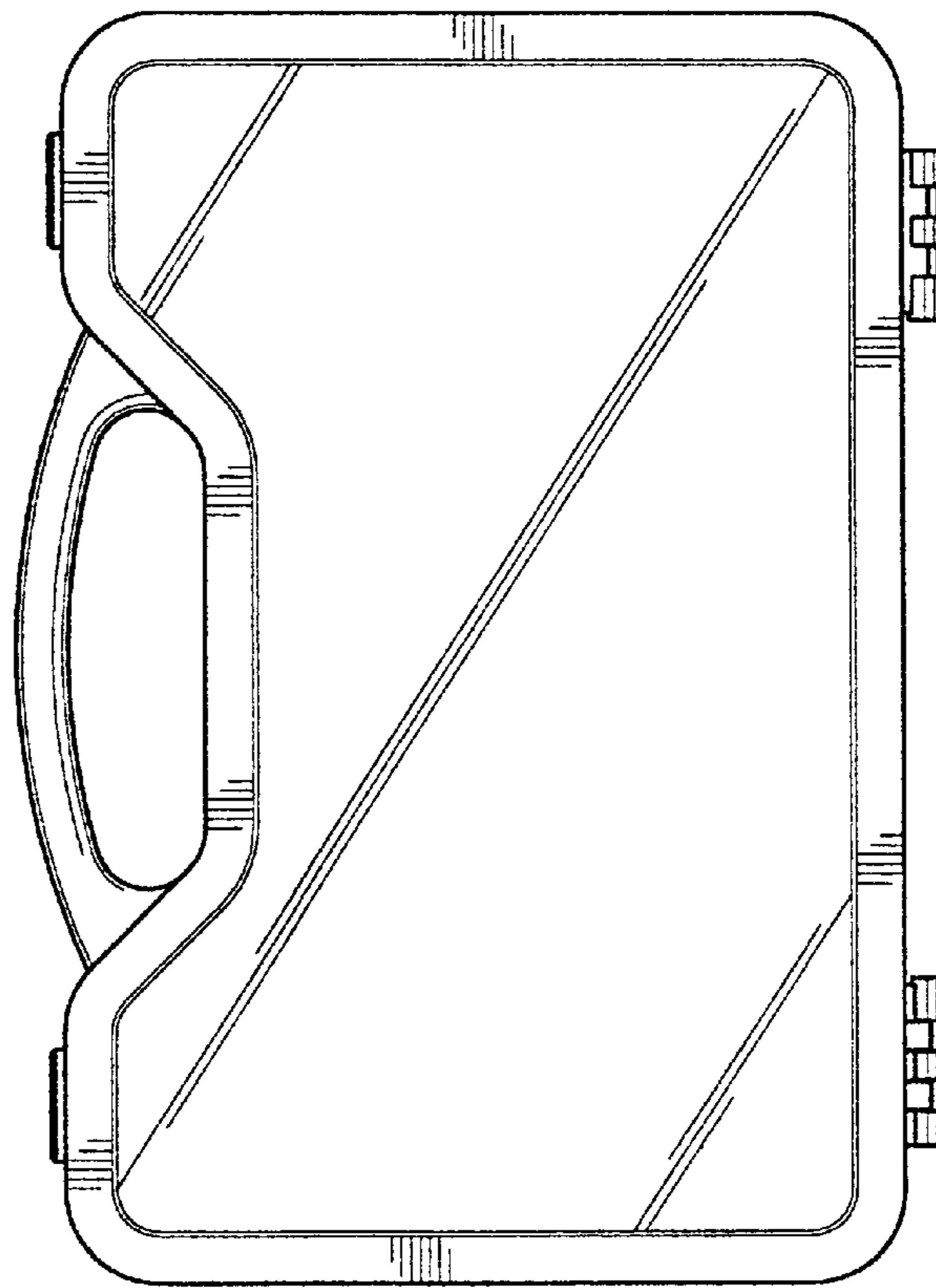

Fig. 1

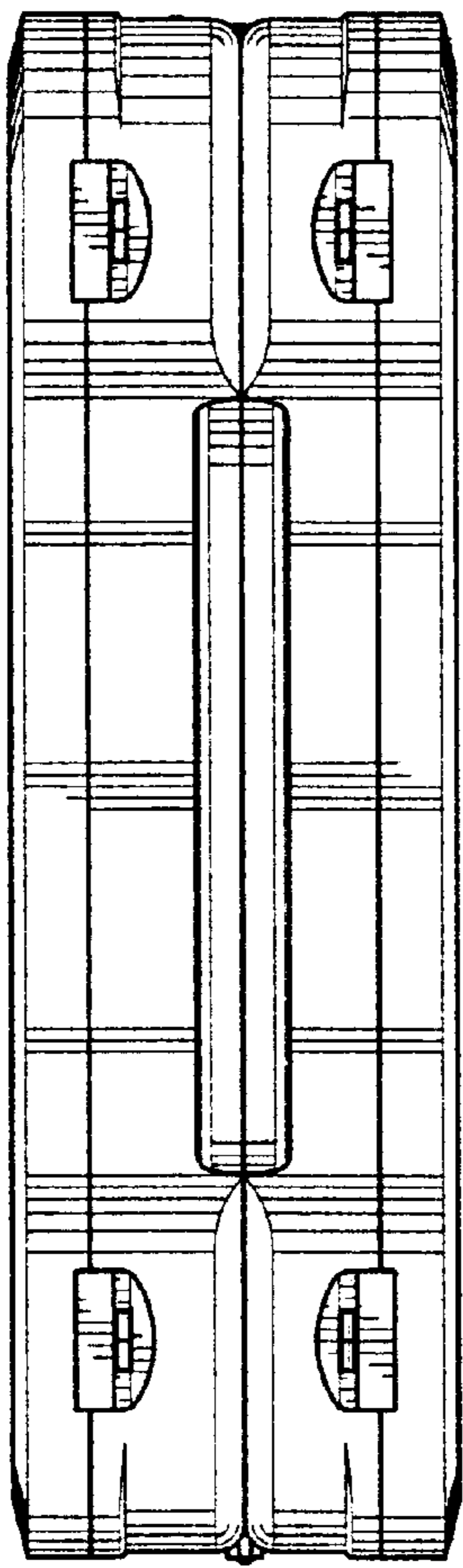

Fig. 3

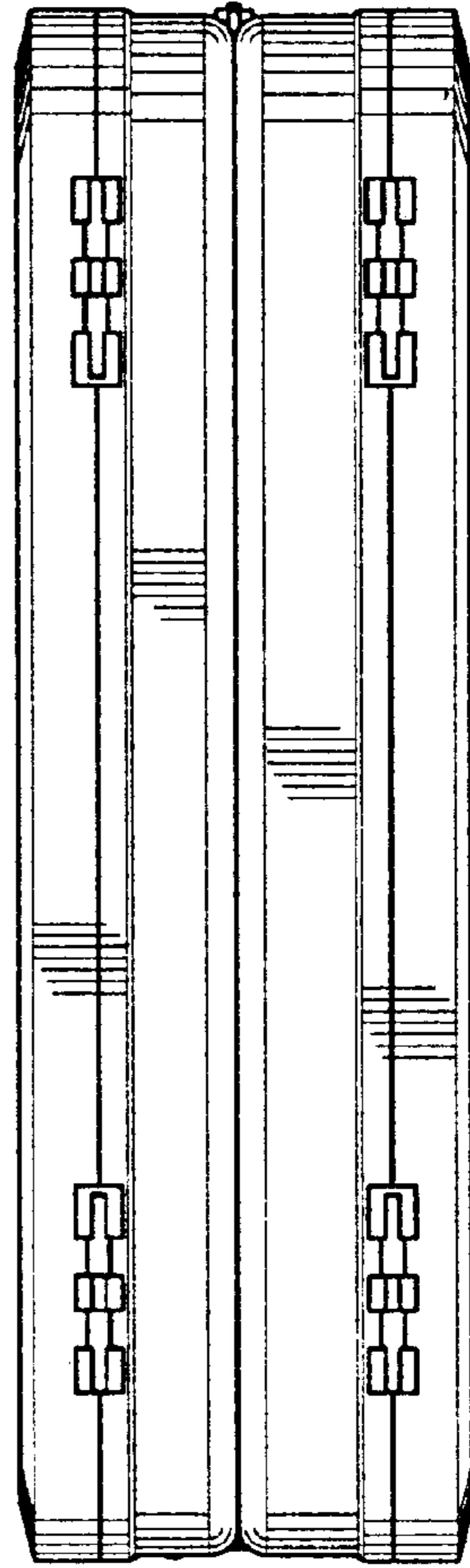

Fig. 4

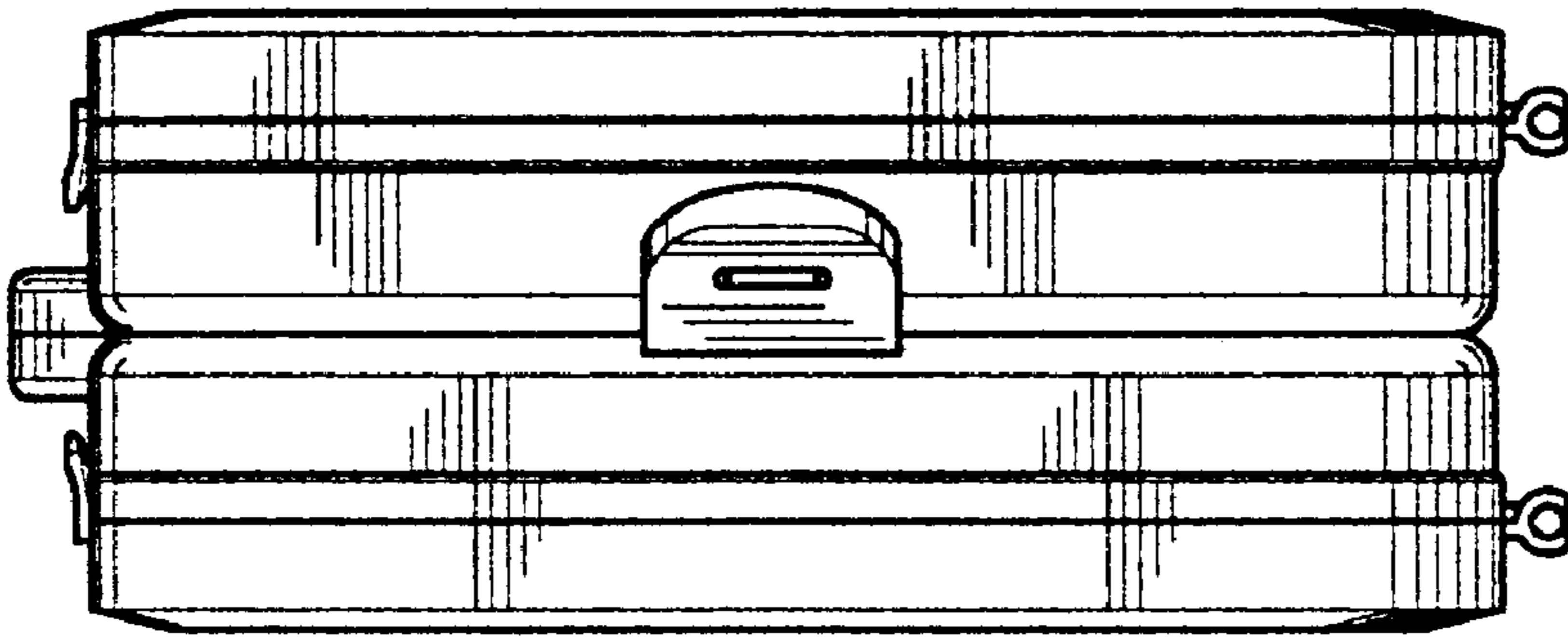

Fig. 6

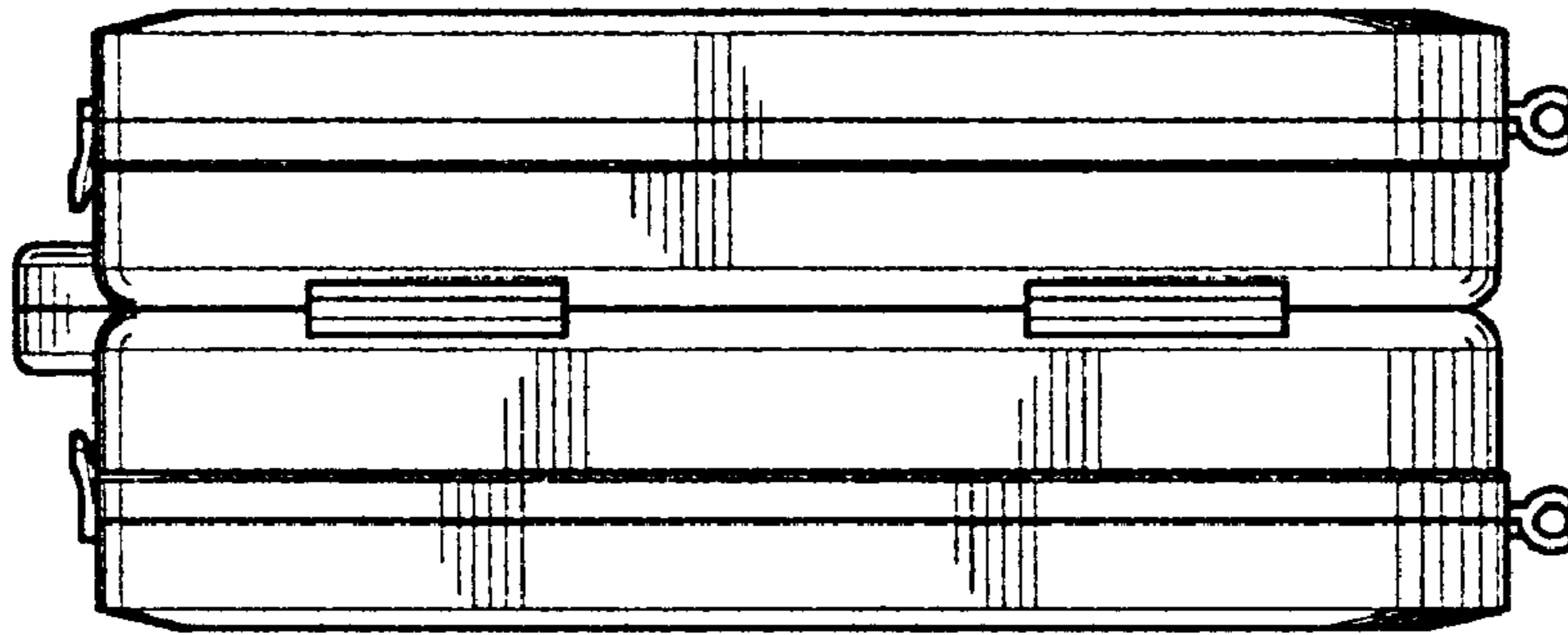

Fig. 5

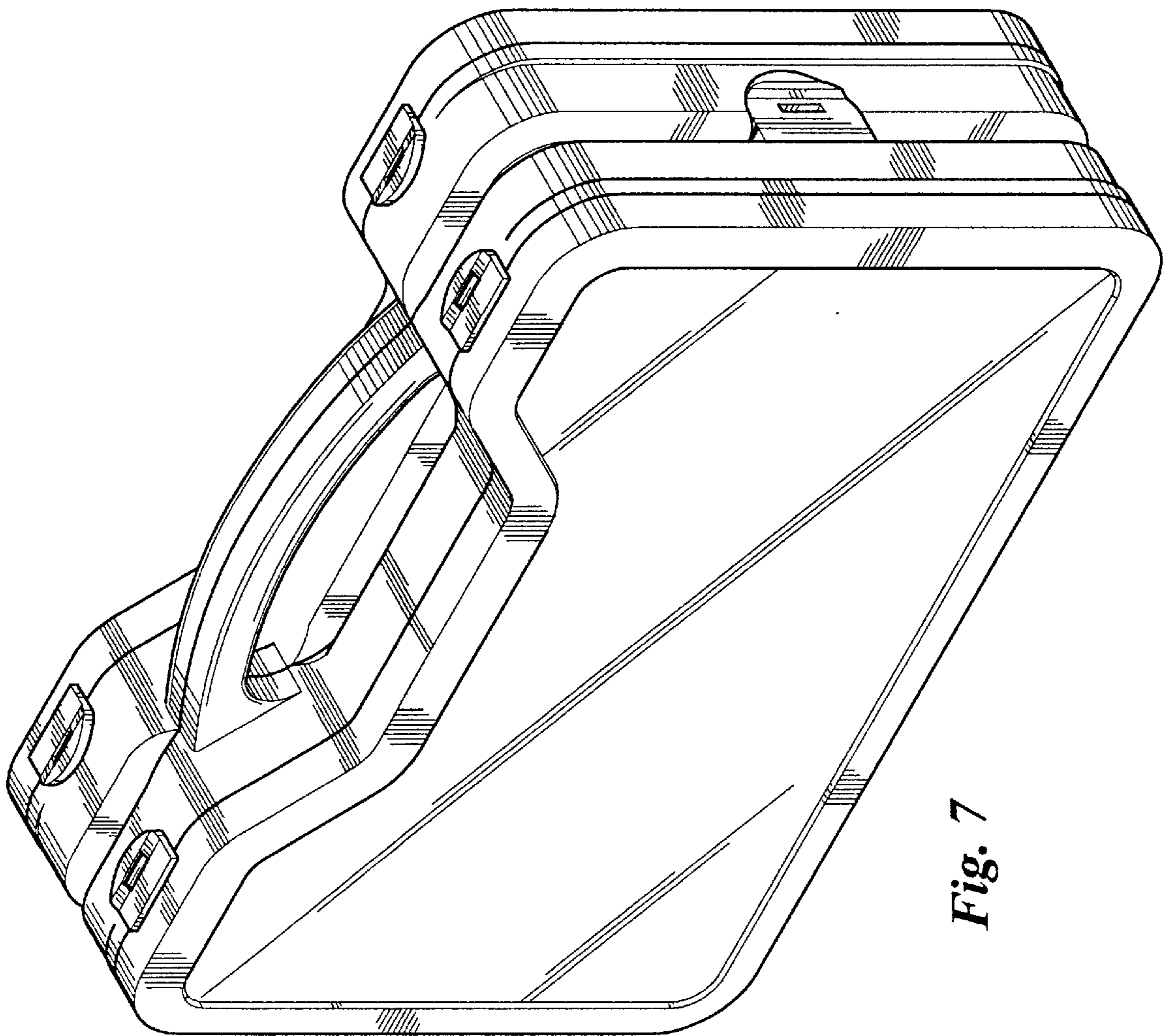

Fig. 7

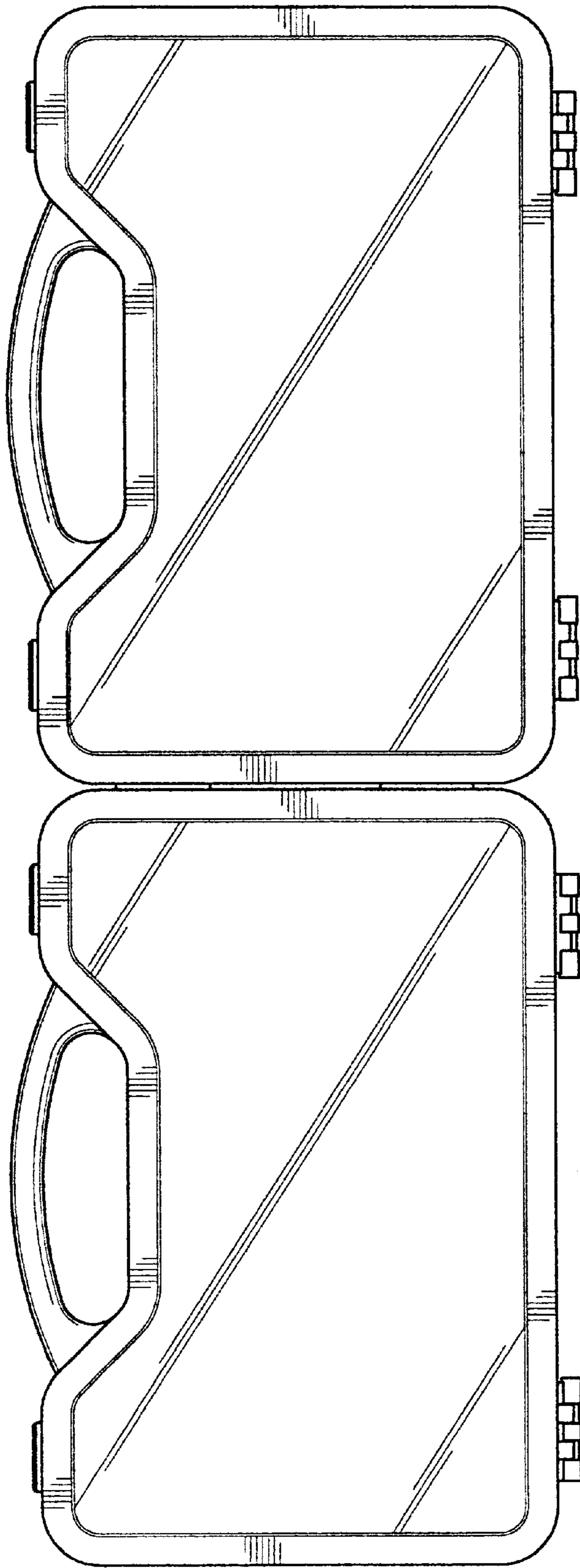

Fig. 8

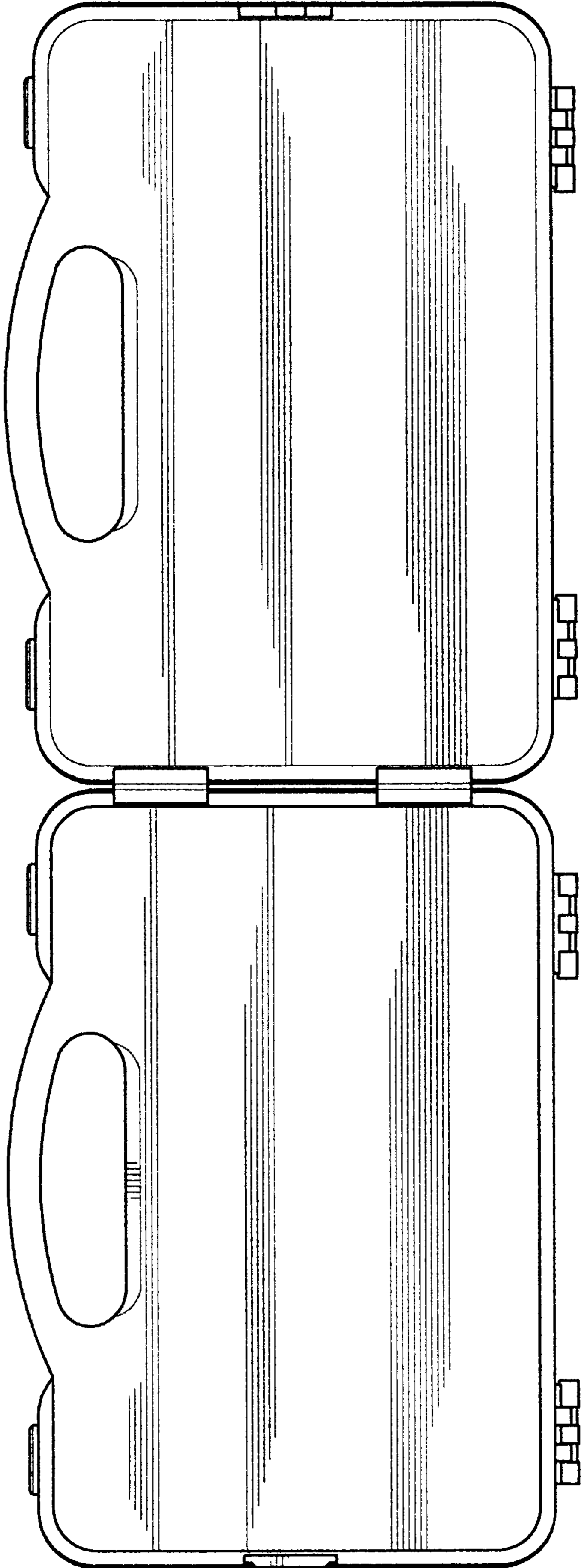

Fig. 9

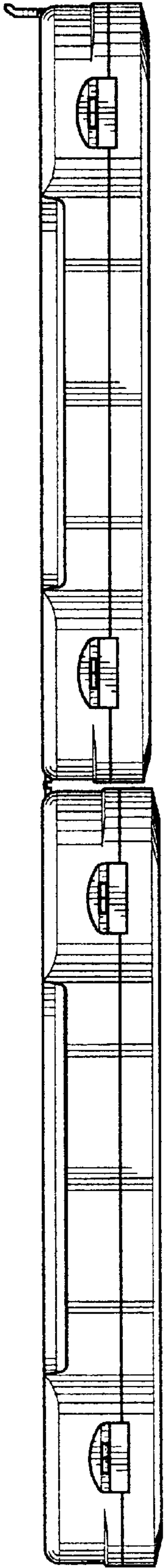

Fig. 10

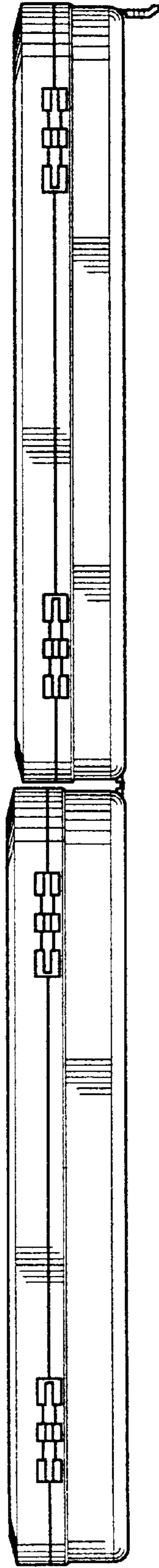

Fig. 11

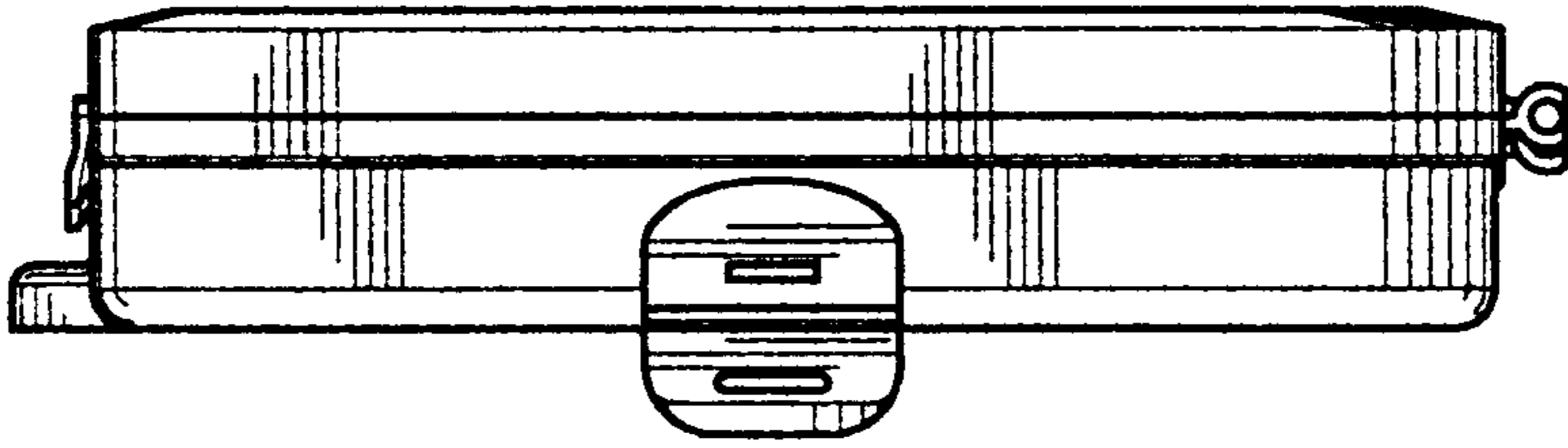

Fig. 13

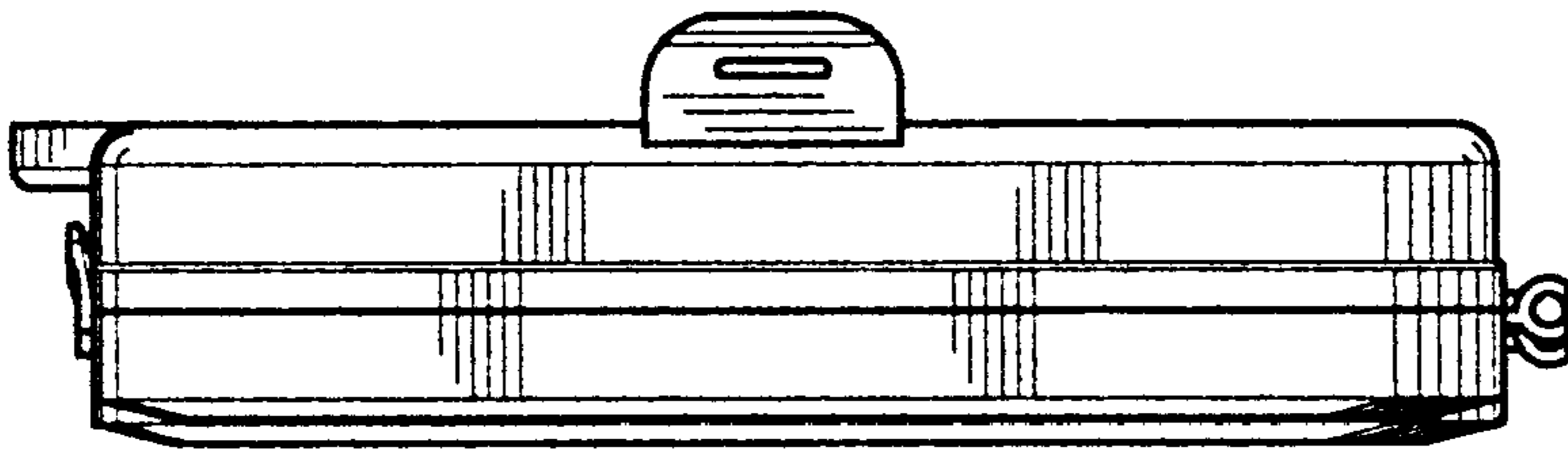

Fig. 12