



US00D412381S

**United States Patent** [19]  
**Peet**

[11] **Patent Number: Des. 412,381**

[45] **Date of Patent: \*\* Jul. 27, 1999**

[54] **FOOT PIECE FOR SHOE DRYERS**

5,632,099 5/1997 Seifert et al. .... 34/106

[76] Inventor: **Gene W. Peet**, P.O. Box 618, St. Maries, Id. 83861

**OTHER PUBLICATIONS**

Photographs of a foot piece for shoe dryers on sale prior to Aug. 31, 1997.

[\*\*] Term: **14 Years**

*Primary Examiner*—Susan J. Lucas  
*Assistant Examiner*—Cynthia E. Ramirez  
*Attorney, Agent, or Firm*—Wells, St. John, Roberts, Gregory & Matkin P.S.

[21] Appl. No.: **29/093,005**

[22] Filed: **Aug. 31, 1998**

[51] **LOC (6) Cl.** ..... **07-05**

[57] **CLAIM**

[52] **U.S. Cl.** ..... **D32/58**

The ornamental design for a foot piece for shoe dryers, as shown and described.

[58] **Field of Search** ..... D32/58, 59; D2/642, D2/641; 34/104, 106, 105, 239; 211/34, 35, 37; 223/113, 114, 120

**DESCRIPTION**

[56] **References Cited**

FIG. 1 is a perspective view of a foot piece for shoe dryers showing my new design;  
FIG. 2 is a left side elevation view thereof, the opposed right side elevation being a mirror image thereof;  
FIG. 3 is a front elevation view thereof;  
FIG. 4 is a rear elevation view thereof;  
FIG. 5 is a top plan elevation view thereof; and,  
FIG. 6 is a bottom plan view thereof.

**U.S. PATENT DOCUMENTS**

D. 310,742	9/1990	Johnson	.....	D32/58
D. 347,094	5/1994	Christensen, Jr.	.....	D32/58
D. 350,633	9/1994	Wong	.....	D32/59
1,281,927	10/1918	Felton	.....	34/106
2,076,735	4/1937	Leindorf	.....	34/104
3,417,482	12/1968	Peet .		
3,805,405	4/1974	Ambos	.....	34/104

**1 Claim, 4 Drawing Sheets**

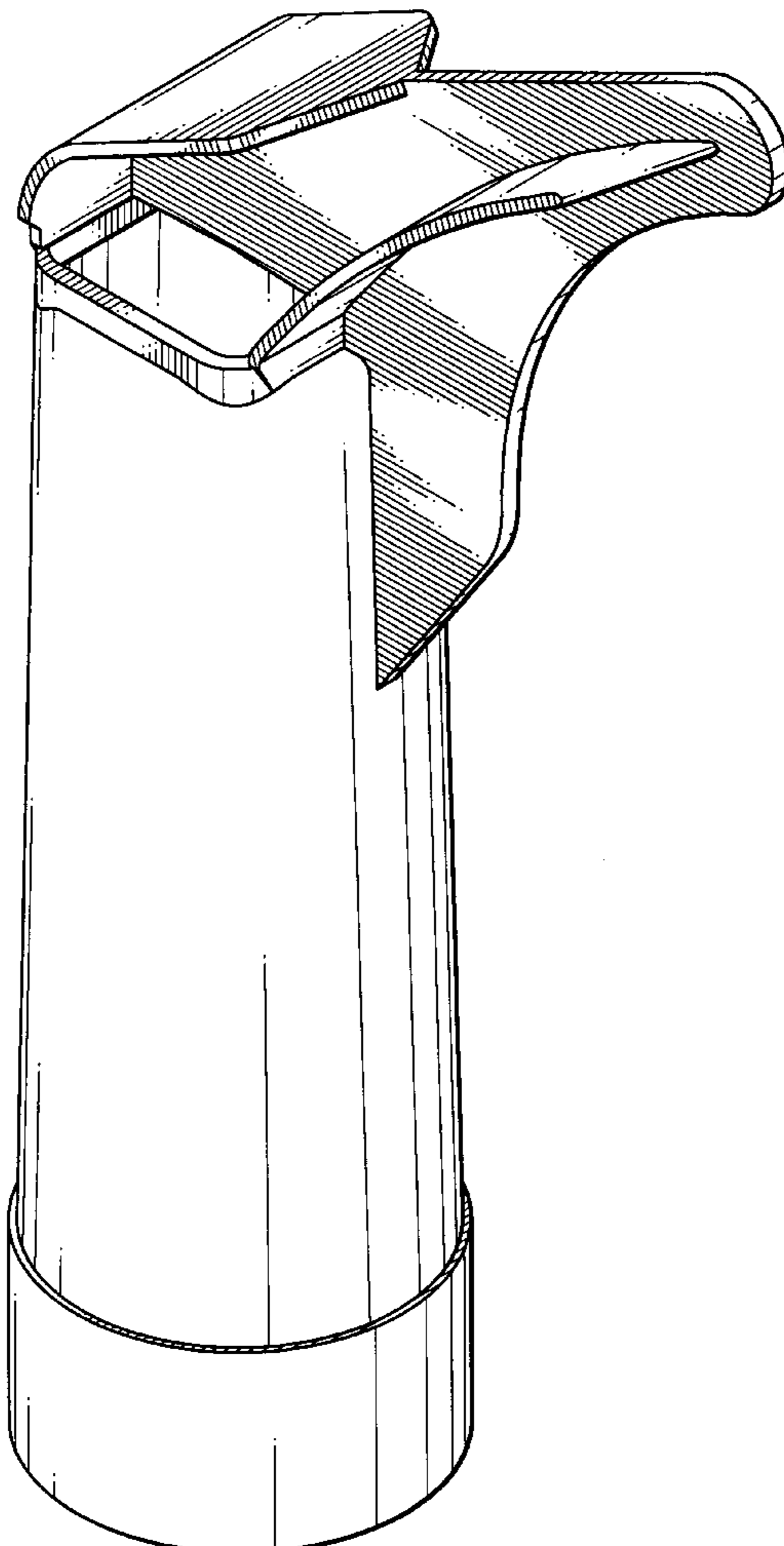

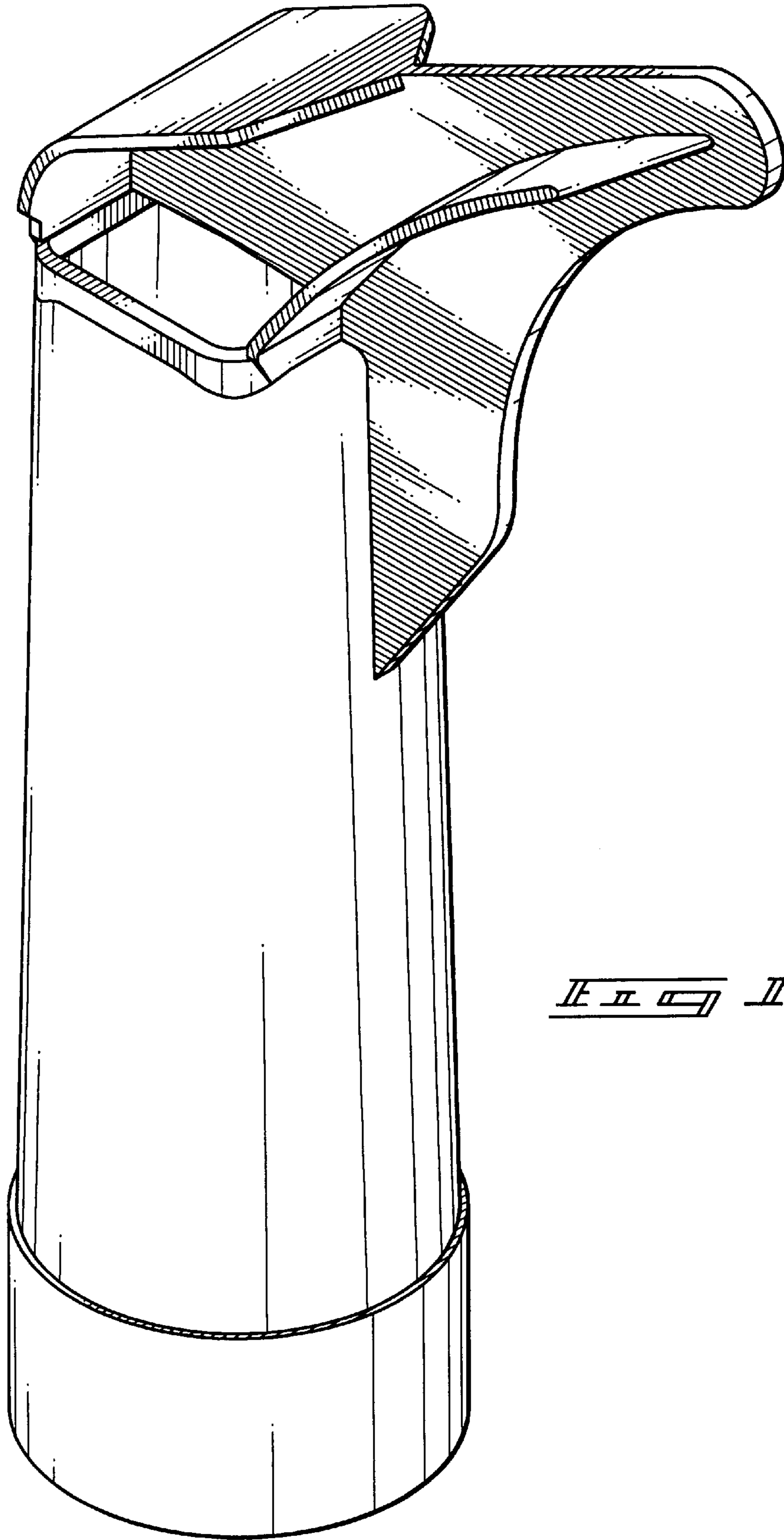

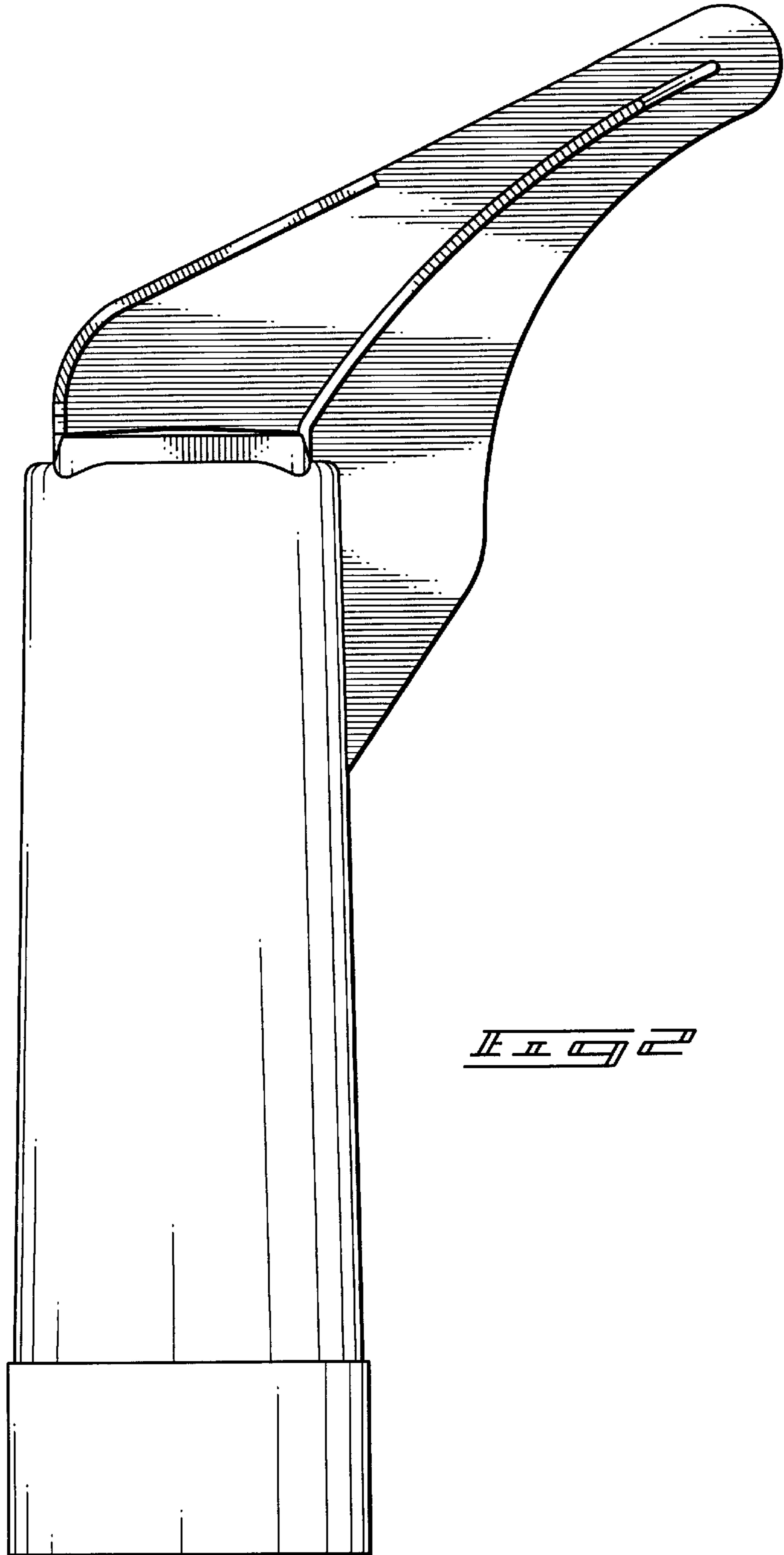

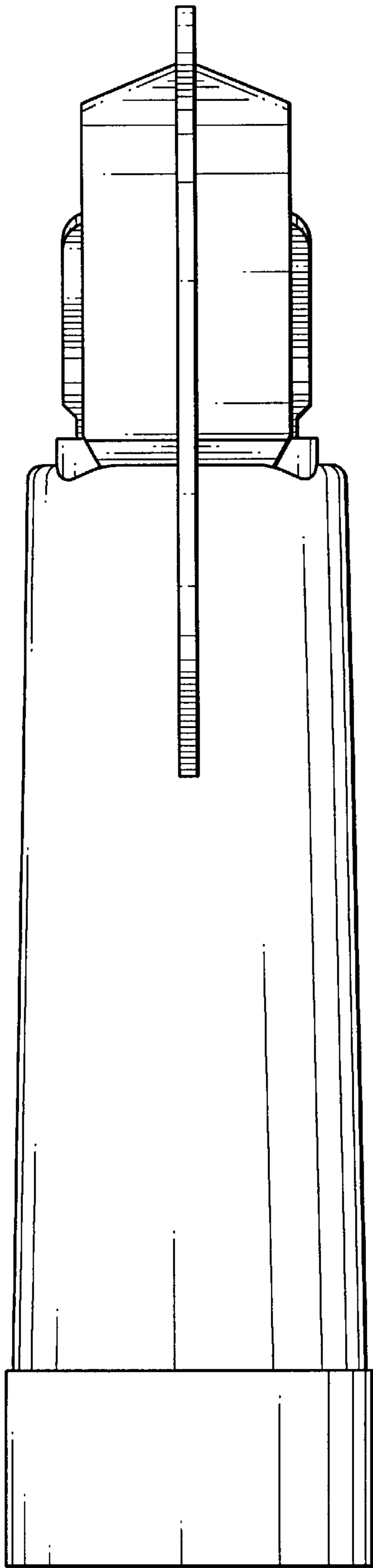

Fig. 1

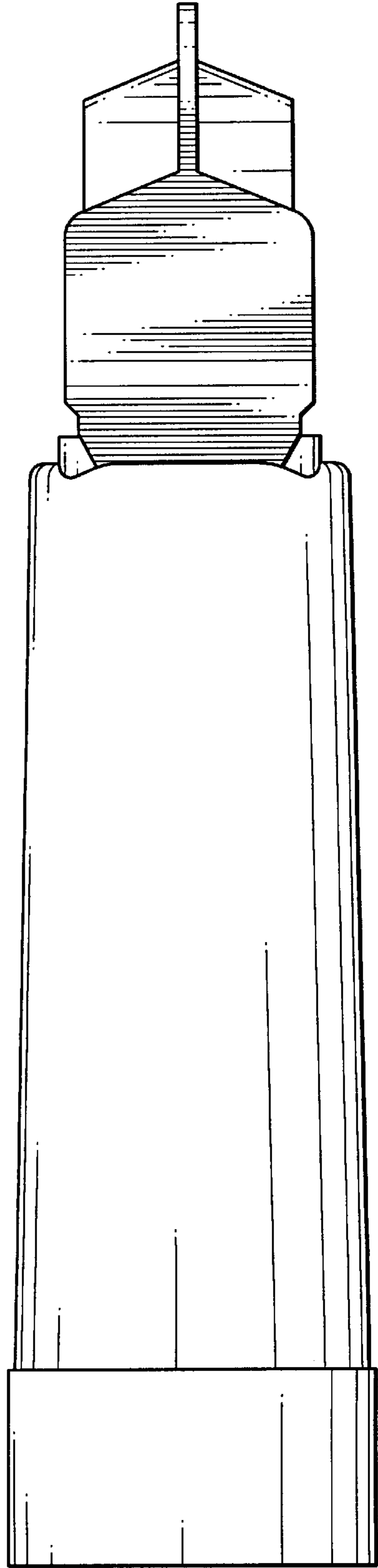

Fig. 2

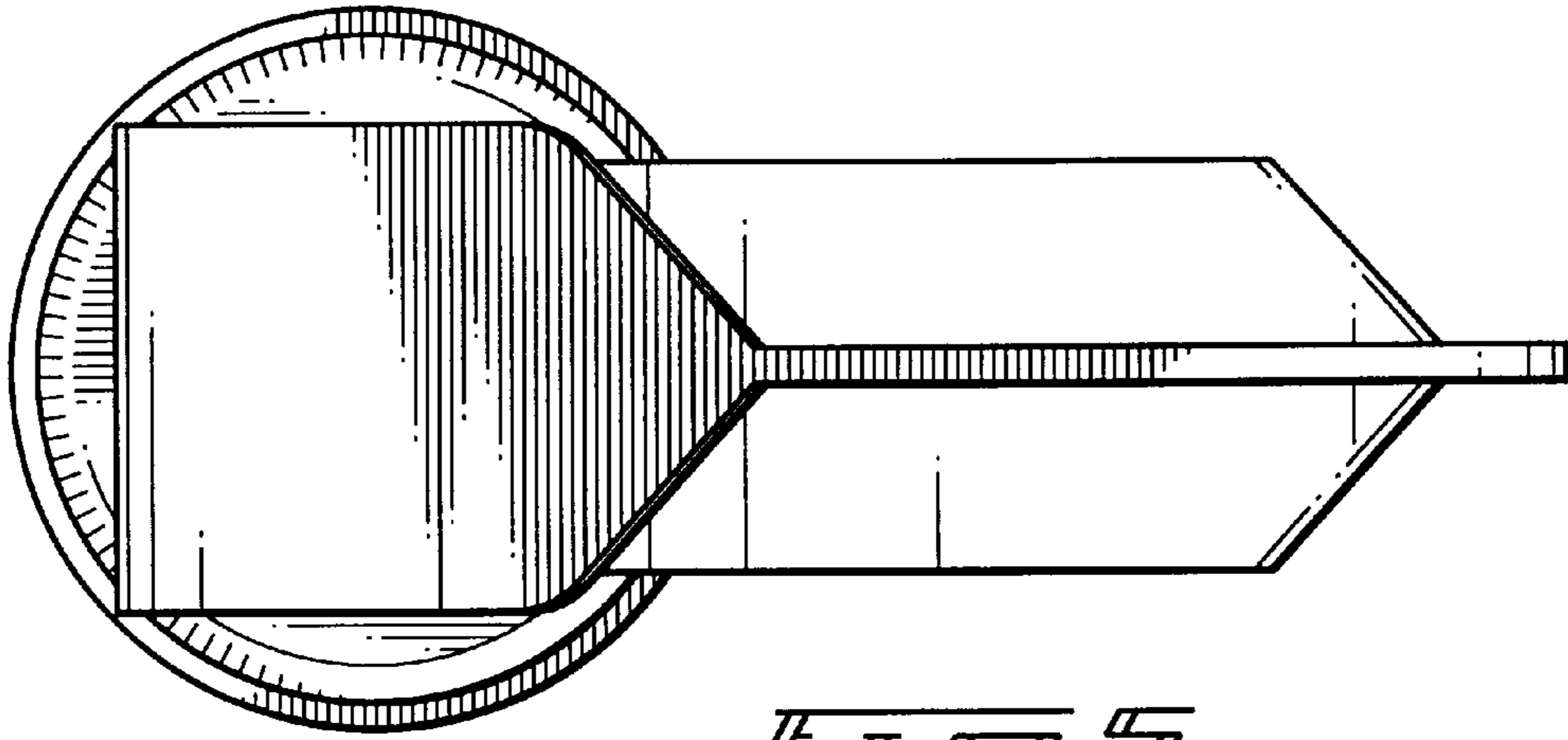

Fig. 5

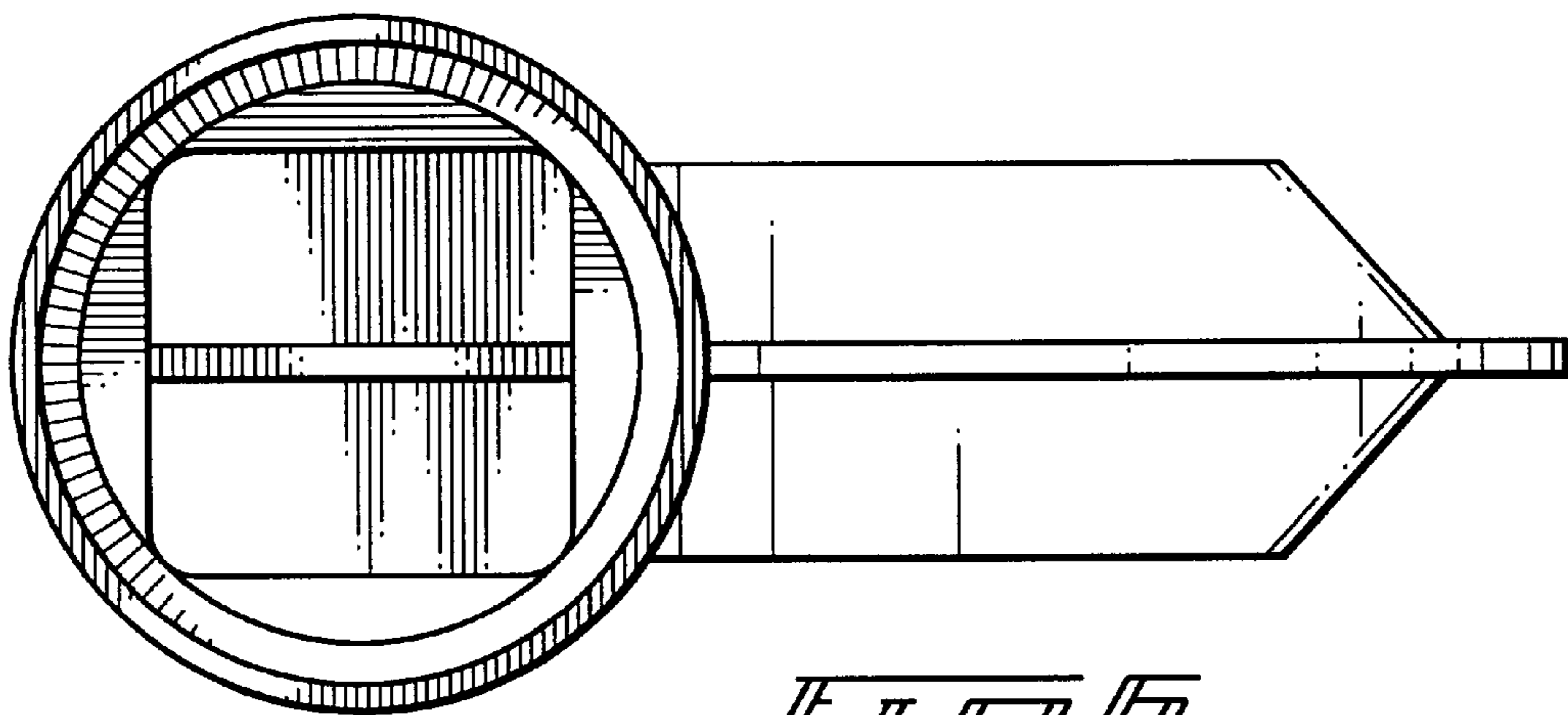

Fig. 6