



US00D412248S

United States Patent [19] Berti

[11] **Patent Number: Des. 412,248**

[45] **Date of Patent: ** Jul. 27, 1999**

[54] **BROOM HEAD**

[75] Inventor: **Enzo Berti**, Dolo/Venice, Italy

[73] Assignee: **The Libman Company**, Arcola, Ill.

[**] Term: **14 Years**

[21] Appl. No.: **29/085,849**

[22] Filed: **Mar. 31, 1998**

[51] **LOC (6) Cl.** **04-01**

[52] **U.S. Cl.** **D4/199; D4/118; D32/50**

[58] **Field of Search** D4/130, 132, 135,
D4/138, 199, 118; D32/50, 51; 15/111,
115, 146, 159.1, 160, 171, 176.1, 186,
187

[56] **References Cited**

U.S. PATENT DOCUMENTS

D. 206,571	1/1967	Herman et al.	D32/50
D. 211,197	5/1968	Malmo	D32/50
774,689	11/1904	McDermott	15/111

OTHER PUBLICATIONS

Home Trends, The Fuller Brush Company Scub Brush—
Item No. SFB109, p. 70, ©1997.

Primary Examiner—Alan P. Douglas
Assistant Examiner—Lavone D. Tabor
Attorney, Agent, or Firm—Marshall, O’Toole, Gerstein,
Murray & Borun

[57] **CLAIM**

The ornamental design for a broom head, as shown and described.

DESCRIPTION

FIG. 1 is a perspective view of a broom head in accordance with the present invention;
FIG. 2 is a top view;
FIG. 3 is a back-end view;
FIG. 4 is a bottom view;
FIG. 5 is a front-end view;
FIG. 6 is a right-side view, the left-side view being a mirror image thereof; and,
FIG. 7 is a perspective view of an alternate embodiment with the only difference residing in the length of the broom head.
The broken lines in the figures show the placement of bristles, and form no part of the design as claimed.

1 Claim, 2 Drawing Sheets

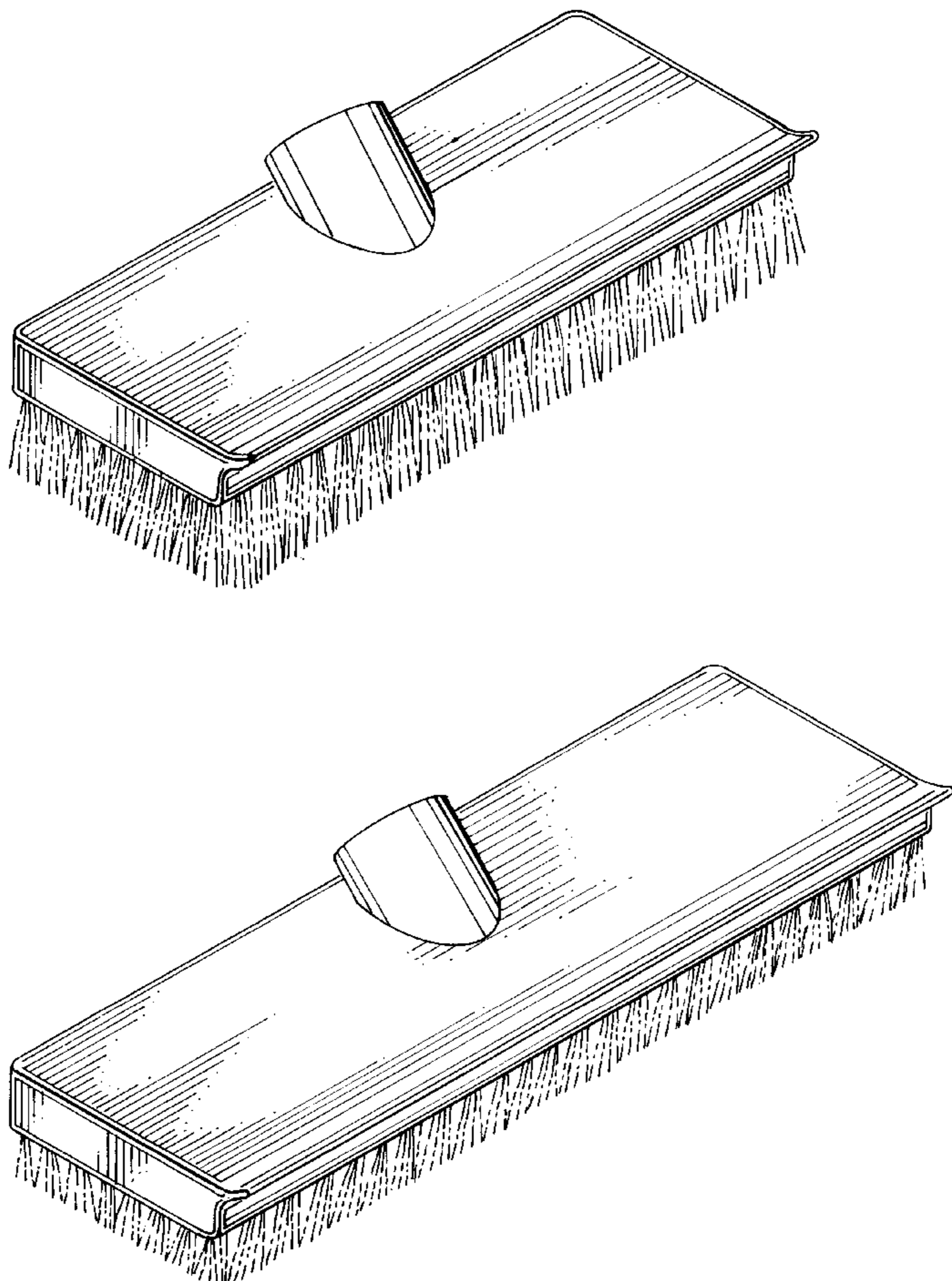

FIG. 1

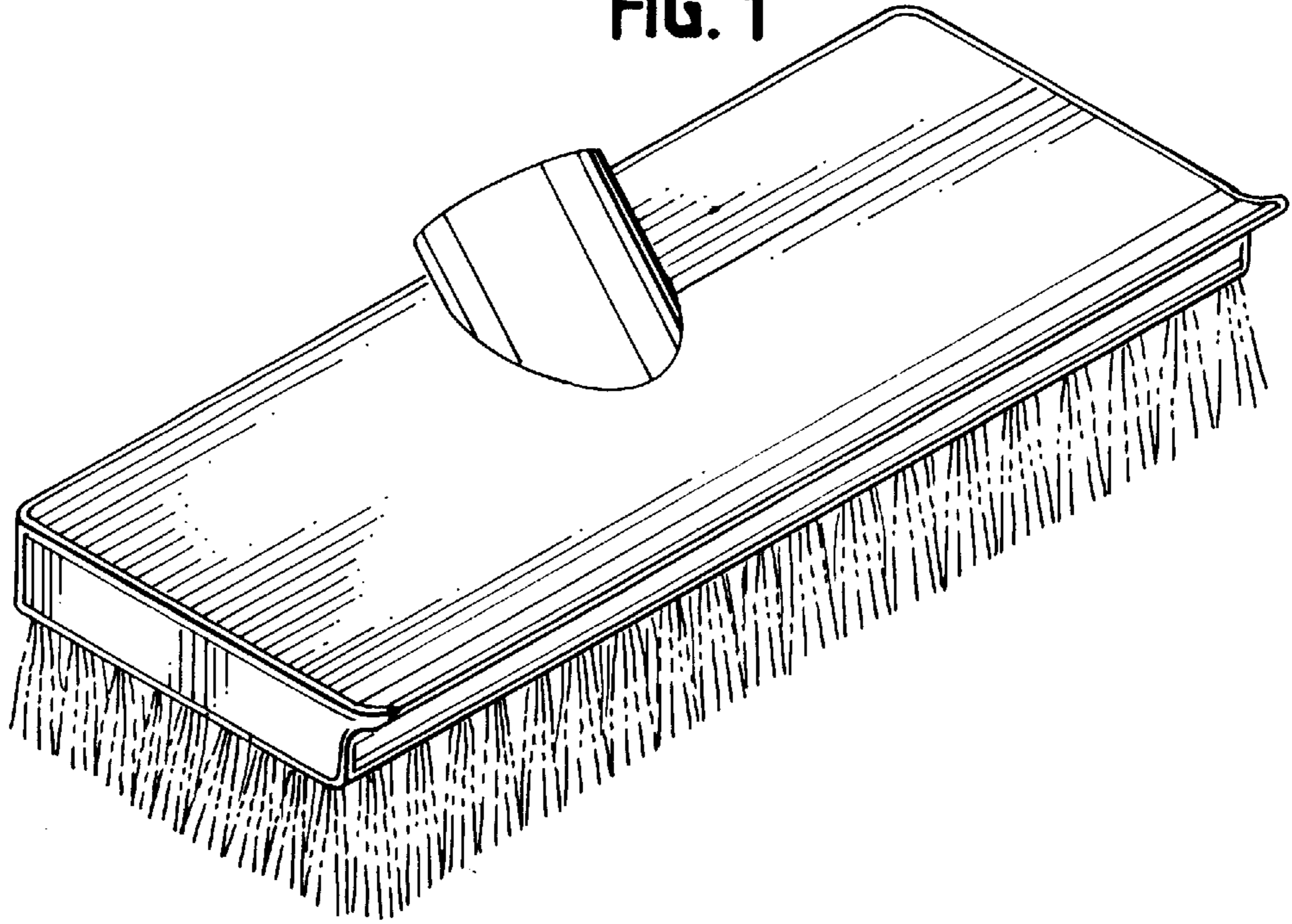

FIG. 2

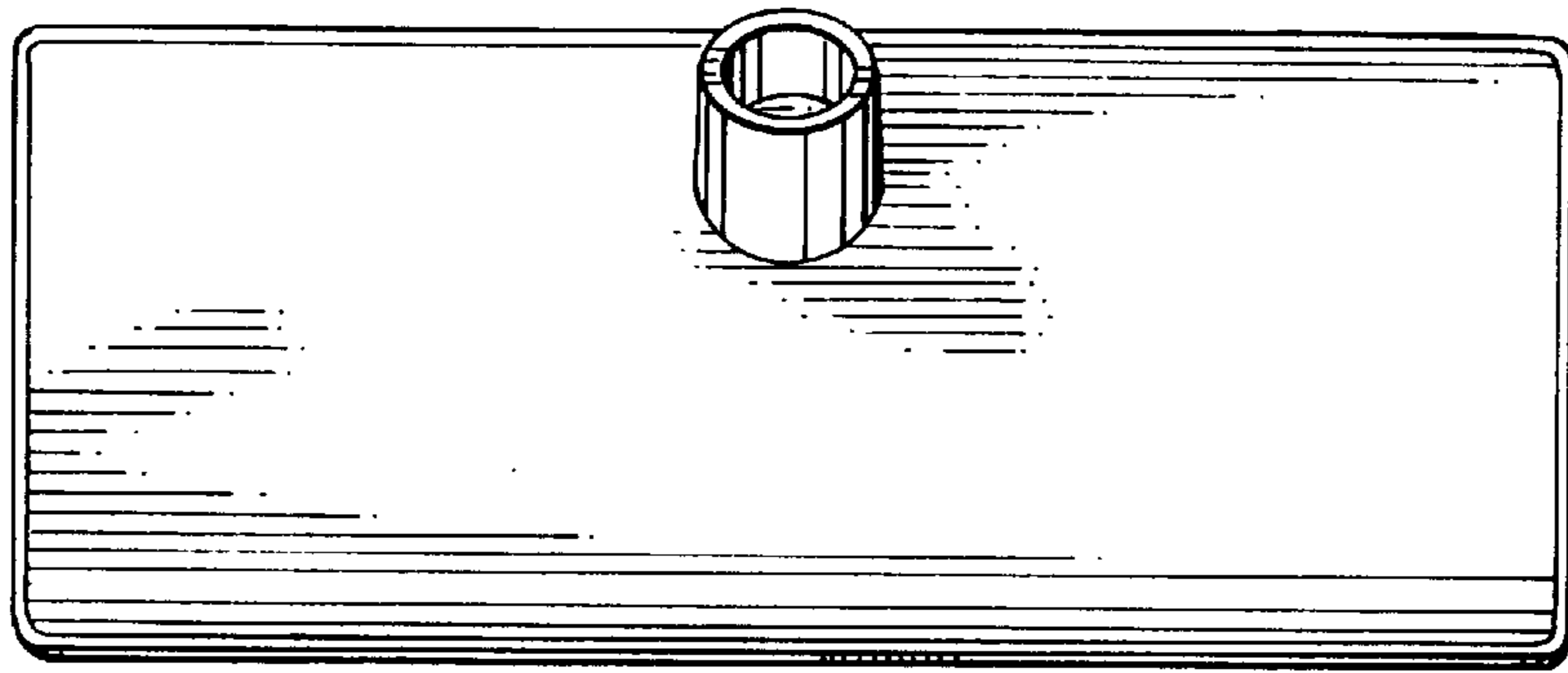

FIG. 3

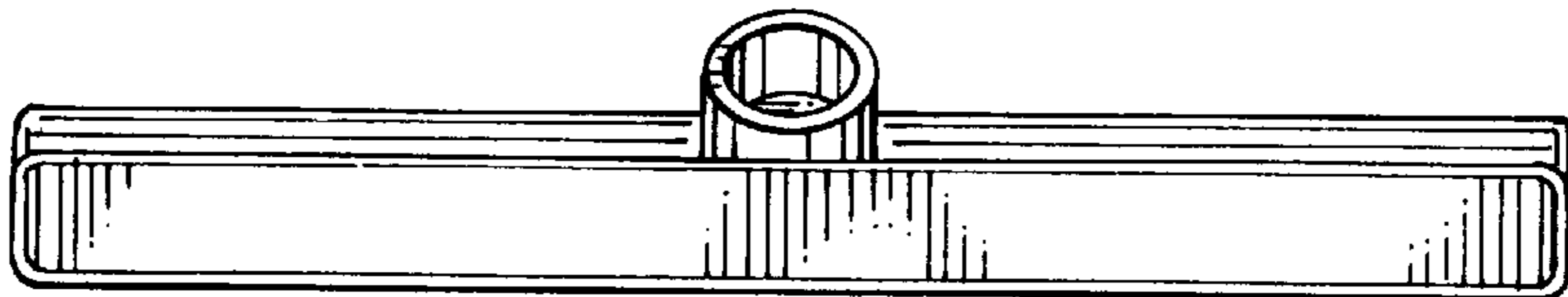

FIG. 4

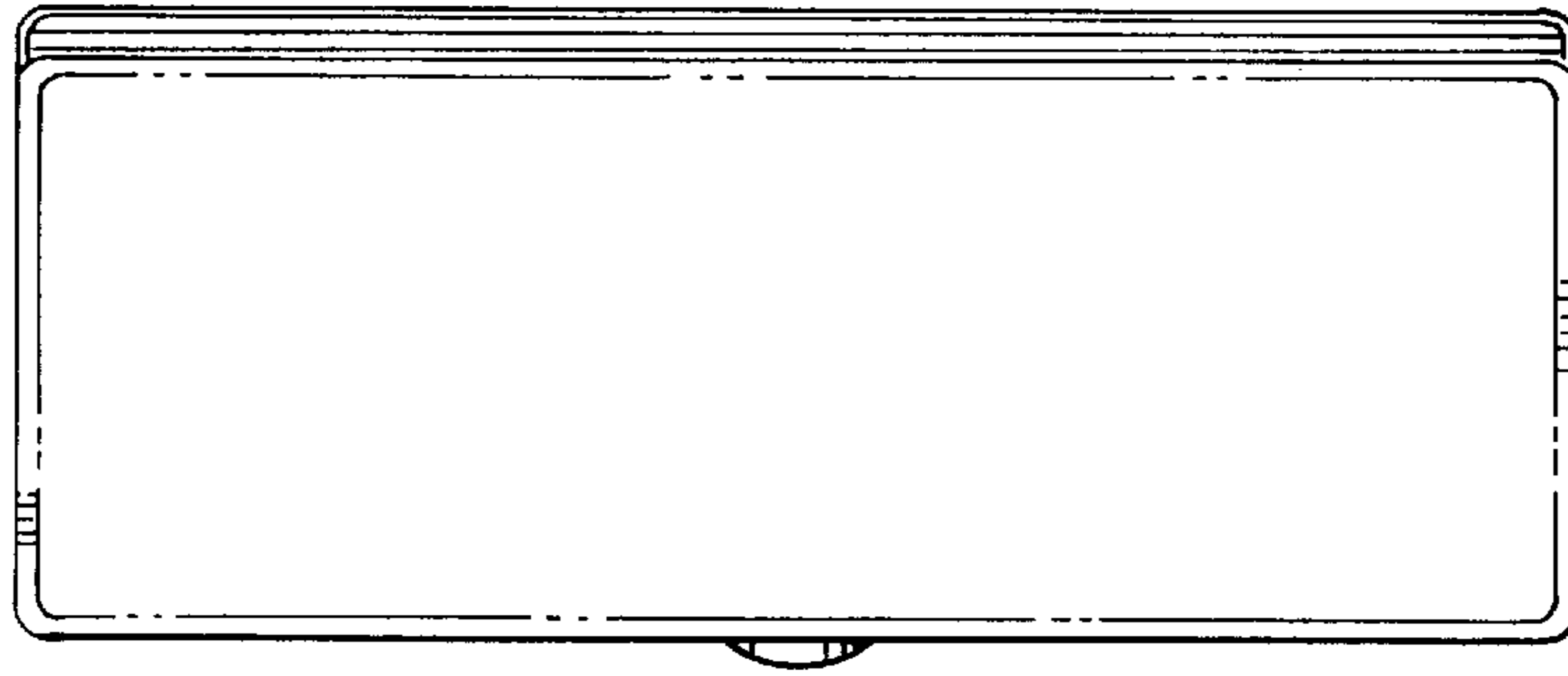

FIG. 5

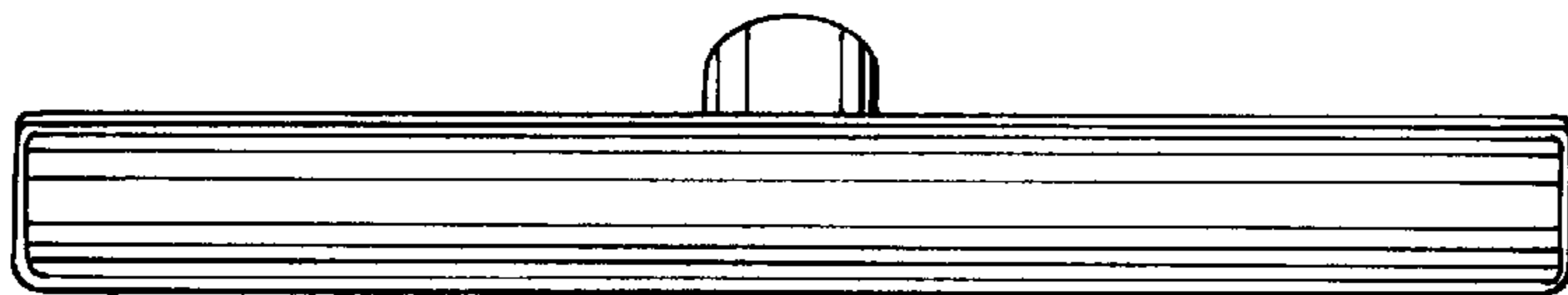

FIG. 6

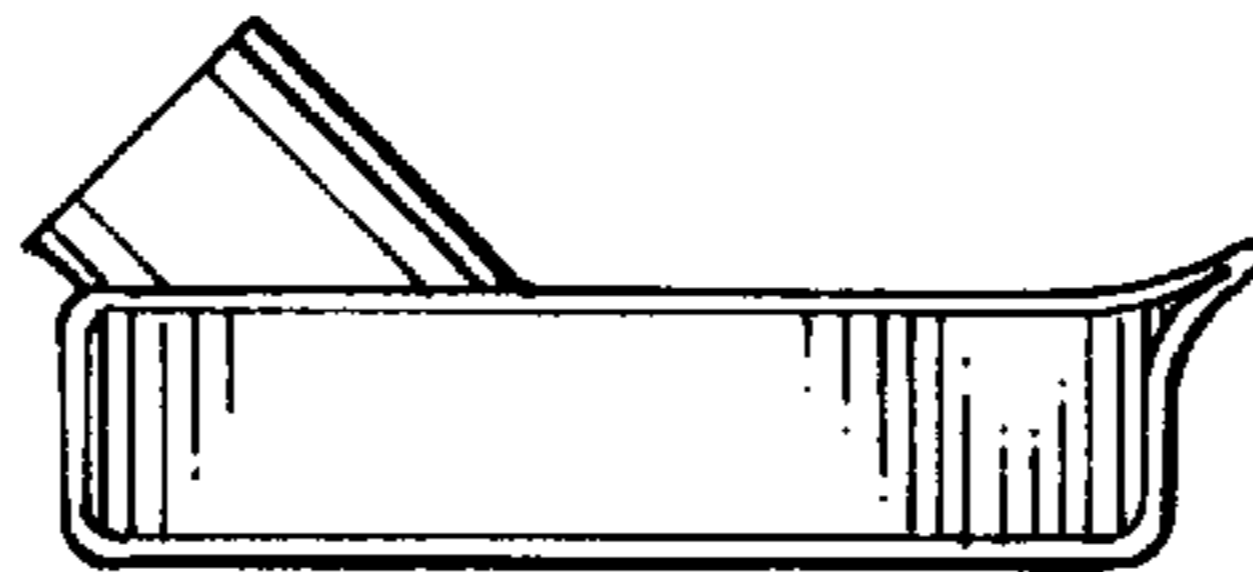

FIG. 7

