



US00D412196S

United States Patent [19]

Asano et al.

[11] Patent Number: Des. 412,196

[45] Date of Patent: ** Jul. 20, 1999

[54] ROTOR FOR SPINNING FISHING REEL

[75] Inventors: **Shinichi Asano**, Musashino; **Akira Yamaguchi**, Higashikurume, both of Japan

[73] Assignee: **Daiwa Seiko, Inc.**, Tokyo, Japan

[**] Term: **14 Years**

[21] Appl. No.: **29/072,825**

[22] Filed: **Jun. 25, 1997**

[51] LOC (6) Cl. **22-05**

[52] U.S. Cl. **D22/141**

[58] Field of Search D22/134, 137, D22/138, 140, 141, 142; 43/4, 18.1, 19, 19.2, 20, 22, 23, 25, 1; 242/224, 230, 232, 233, 311

[56] References Cited

U.S. PATENT DOCUMENTS

D. 246,049	10/1977	Nakamura	D22/138
D. 273,975	5/1984	Sakumoto et al.	D22/141
D. 285,823	9/1986	Iinuma et al.	D22/141
D. 309,936	8/1990	Hiraishi et al.	..	
D. 355,014	1/1995	Furomoto	D22/141
D. 355,015	1/1995	Furomoto	D22/141
D. 355,016	1/1995	Furomoto	D22/141
D. 355,017	1/1995	Furomoto	D22/141
D. 355,018	1/1995	Furomoto	D22/141

D. 356,621	3/1995	Furomoto	D22/141
D. 357,726	4/1995	Furomoto	D22/141
D. 374,060	9/1996	Asano et al.	D22/141
D. 374,269	10/1996	Asano et al.	D22/141
D. 375,301	11/1996	Furomoto	D22/141
4,426,045	1/1984	Gifford	242/232
5,333,811	8/1994	Hitomi	242/232
5,379,957	1/1995	Furomoto et al.	242/230
5,765,781	6/1998	Tsutsumi	242/232

FOREIGN PATENT DOCUMENTS

652505 6/1985 Japan .

Primary Examiner—Louis S. Zarfaz
Assistant Examiner—Inga-Maria Hyttinen
Attorney, Agent, or Firm—Longacre & White

[57] CLAIM

The ornamental design for a rotor for spinning fishing reel, as shown and described.

DESCRIPTION

FIG. 1 is a top, front and right side perspective view of a rotor for spinning fishing reel showing our new design; FIG. 2 is a left side elevational view thereof; FIG. 3 is a front elevational view thereof; FIG. 4 is a right side elevational view thereof; FIG. 5 is a rear elevational view thereof; FIG. 6 is a top plan view thereof; and, FIG. 7 is a bottom view thereof.

1 Claim, 2 Drawing Sheets

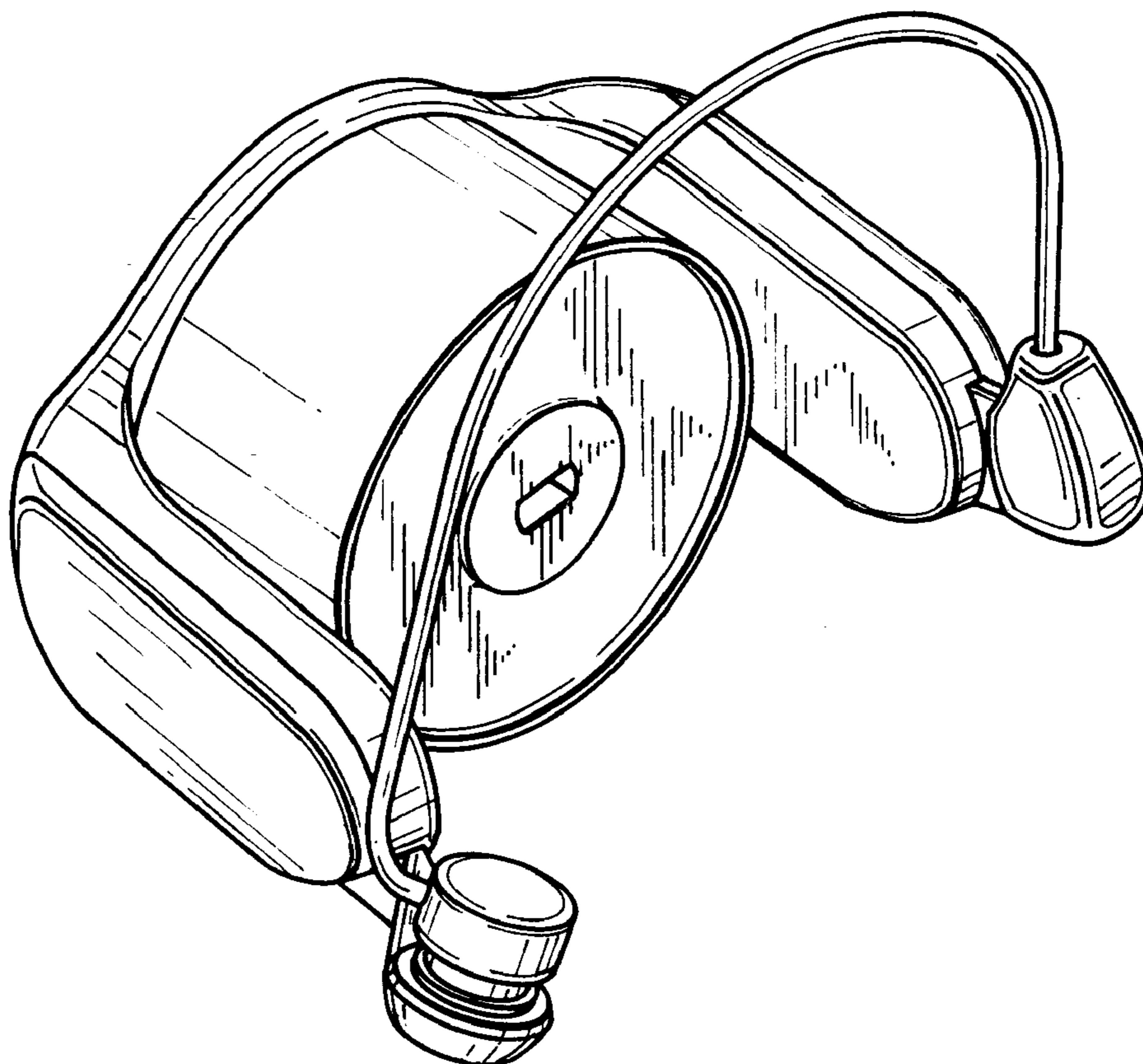

FIG. 1

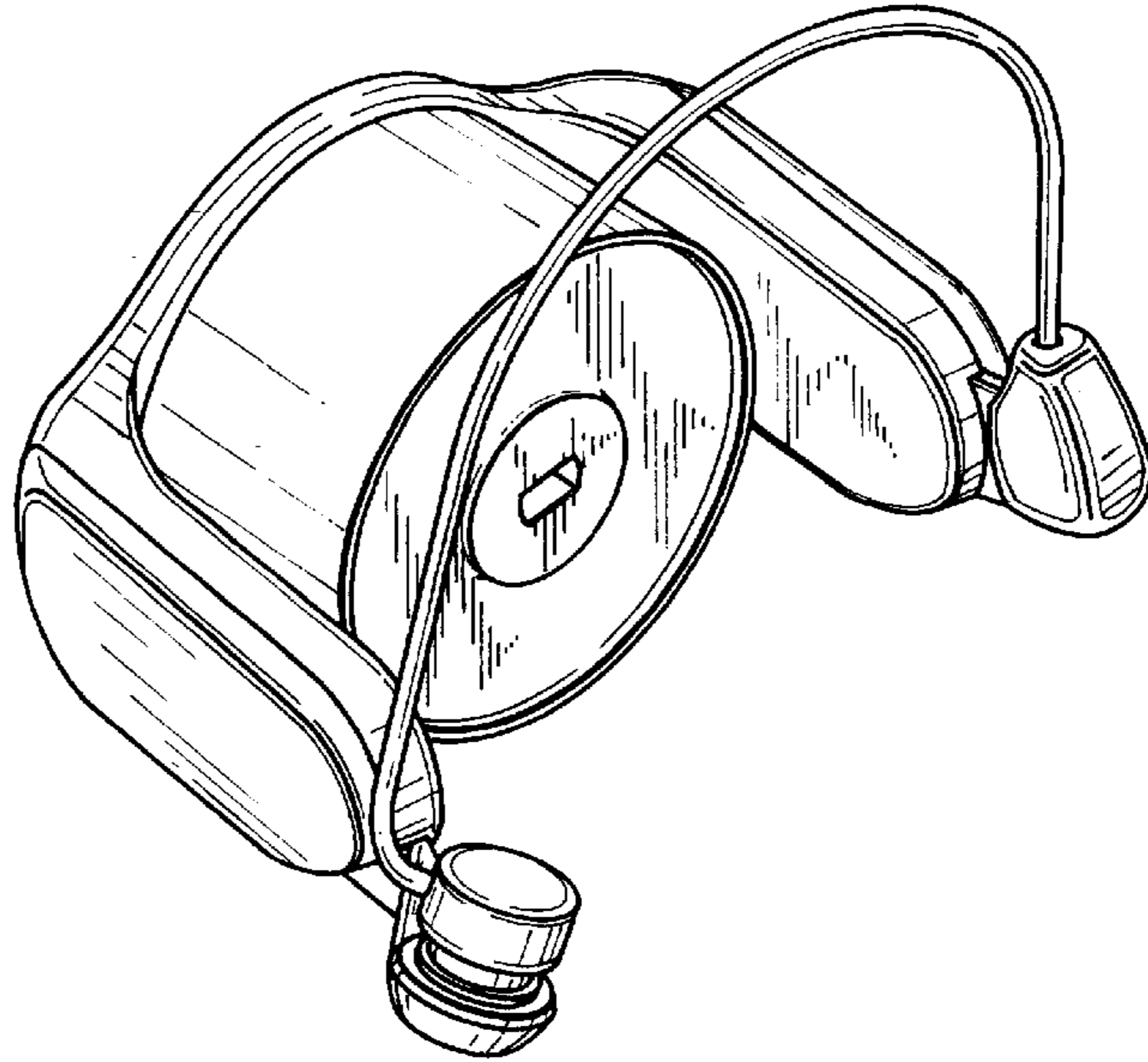

FIG. 2

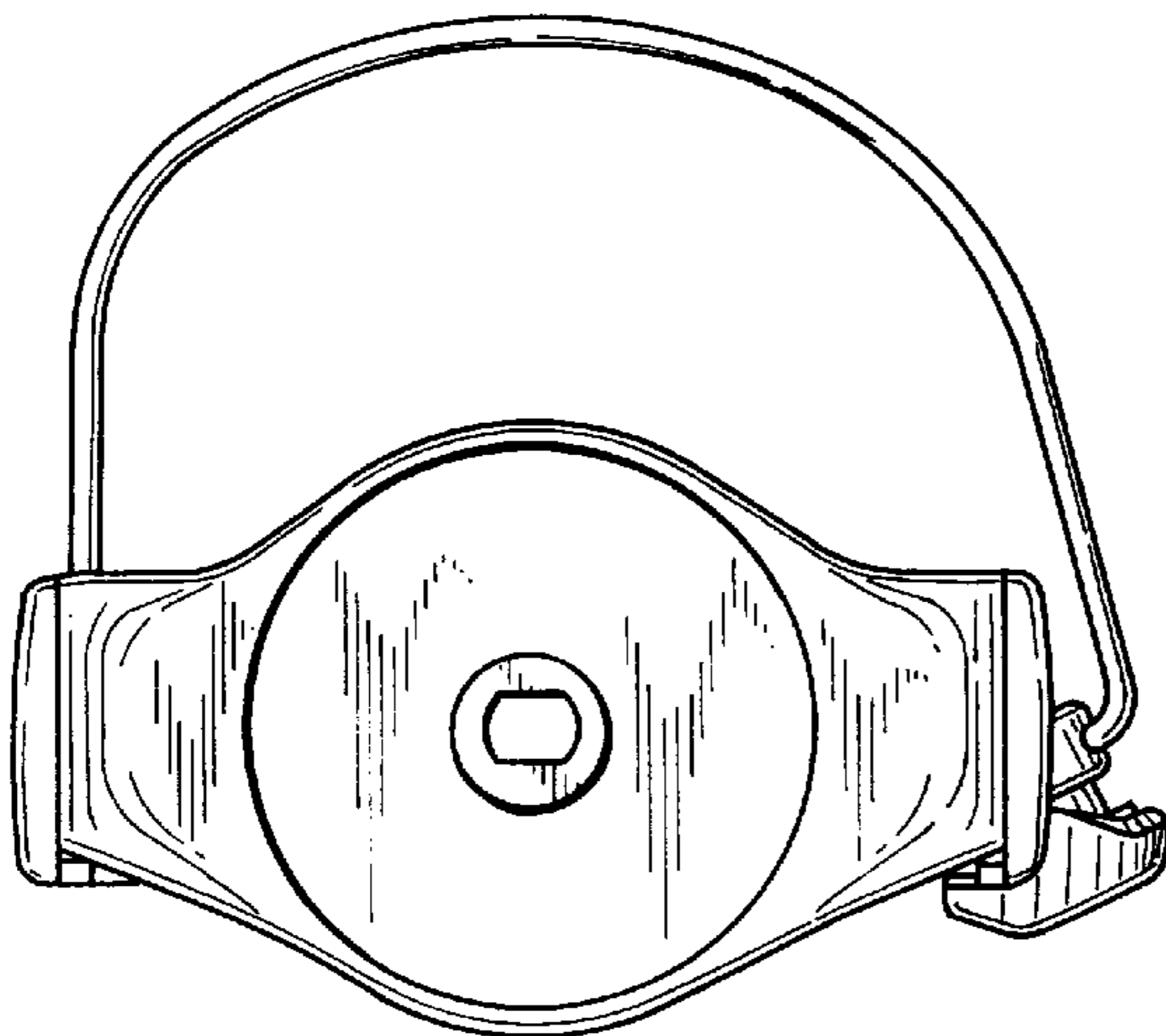

FIG. 3

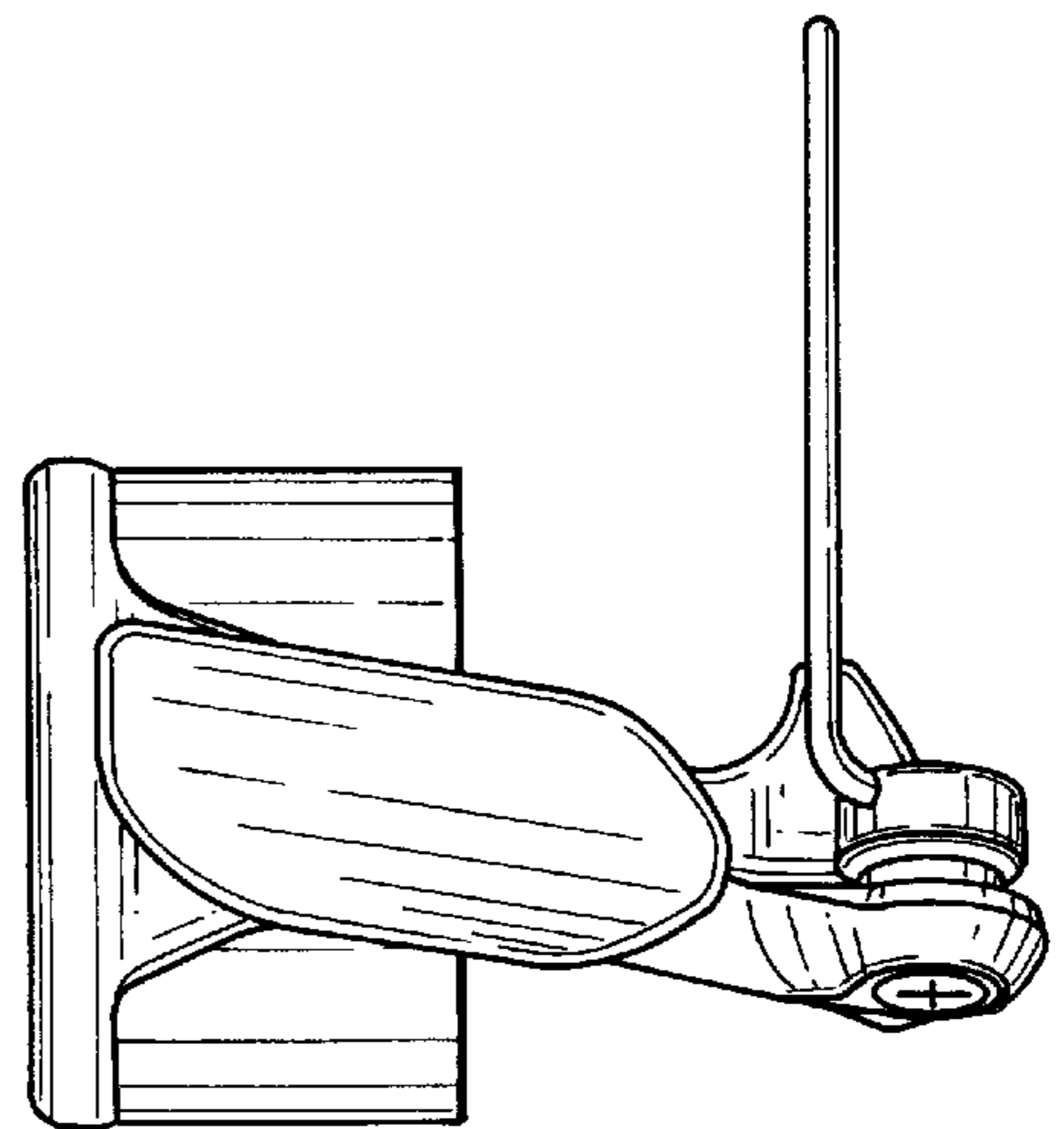

FIG. 4

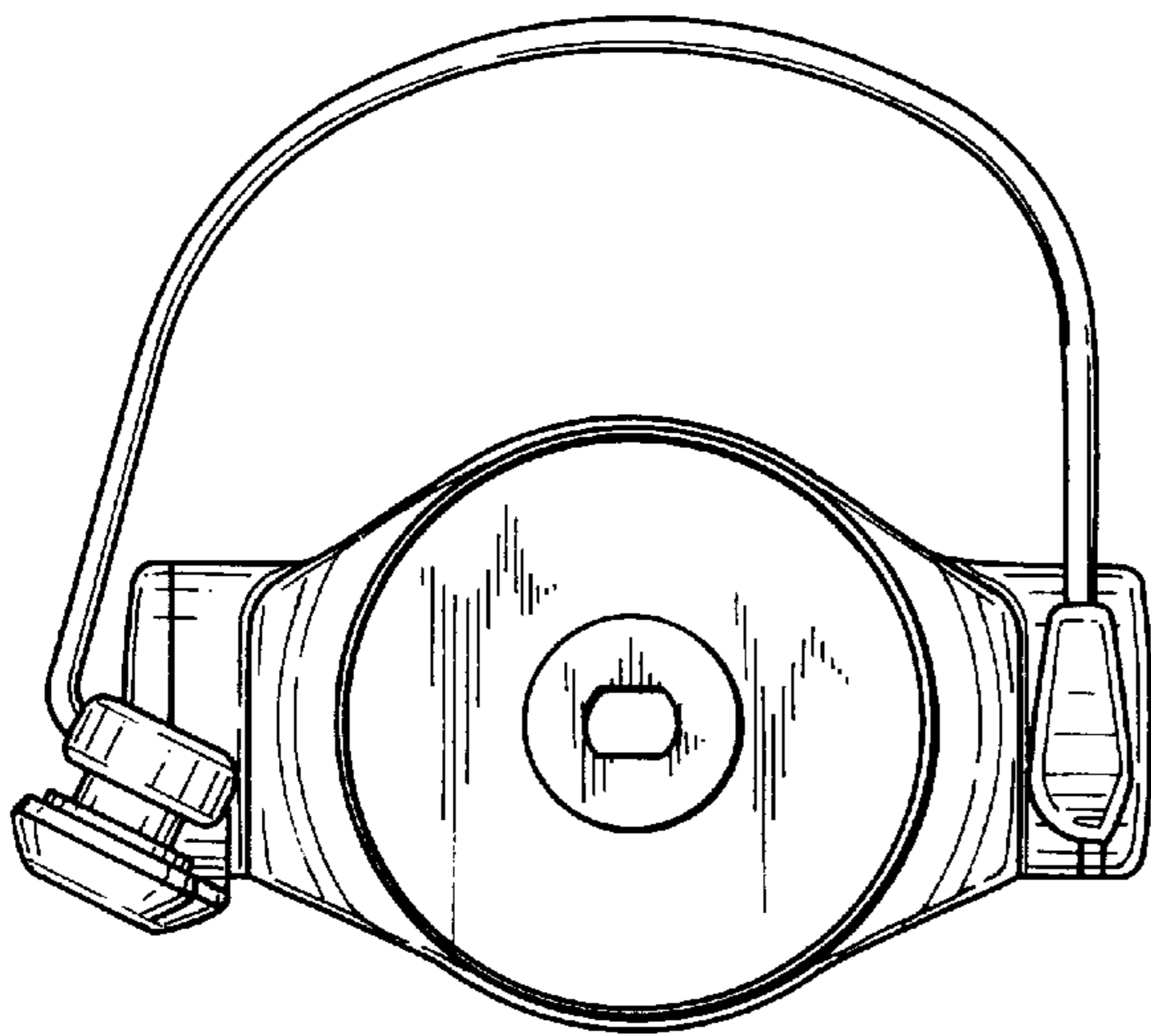

FIG. 5

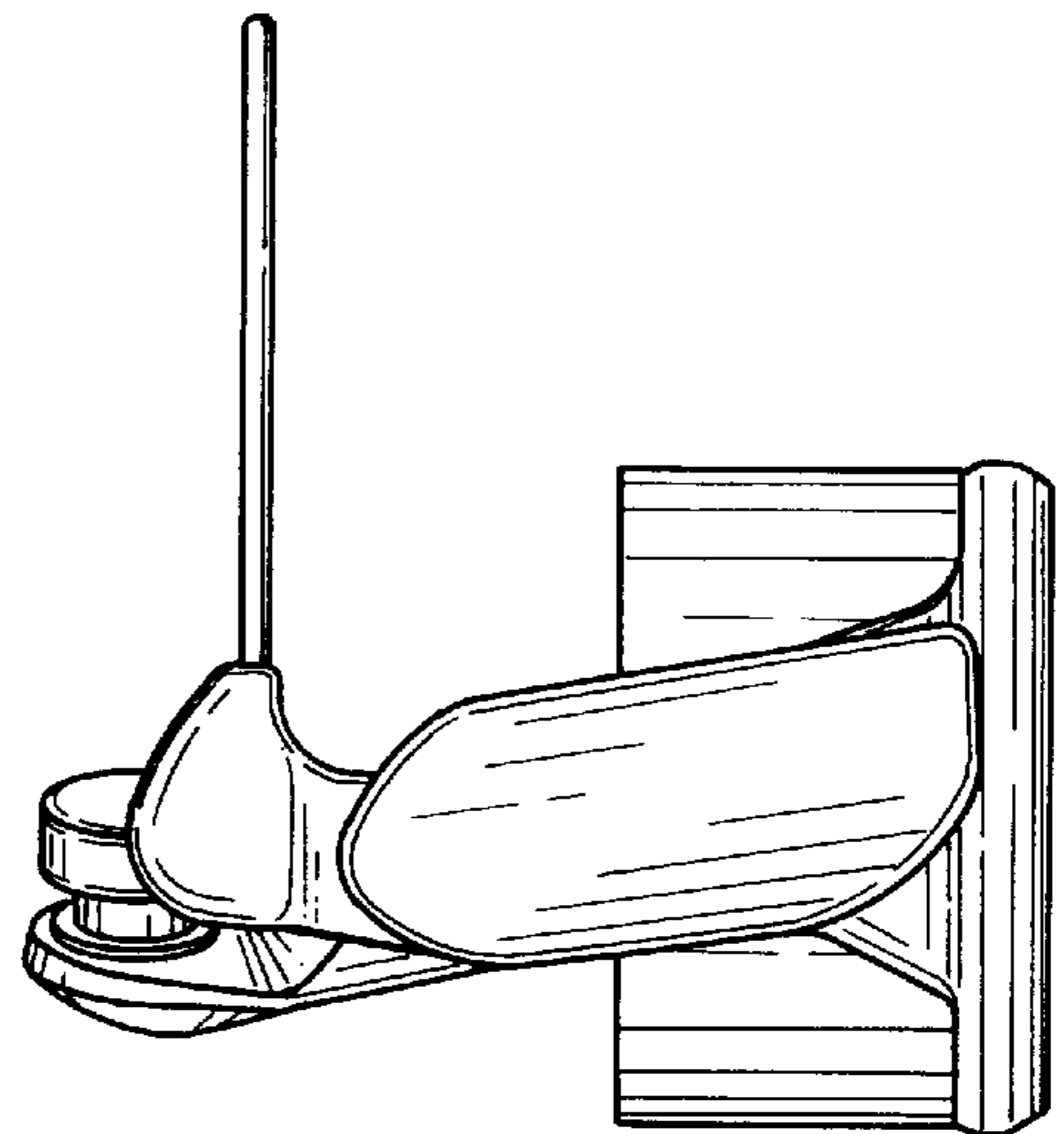

FIG. 6

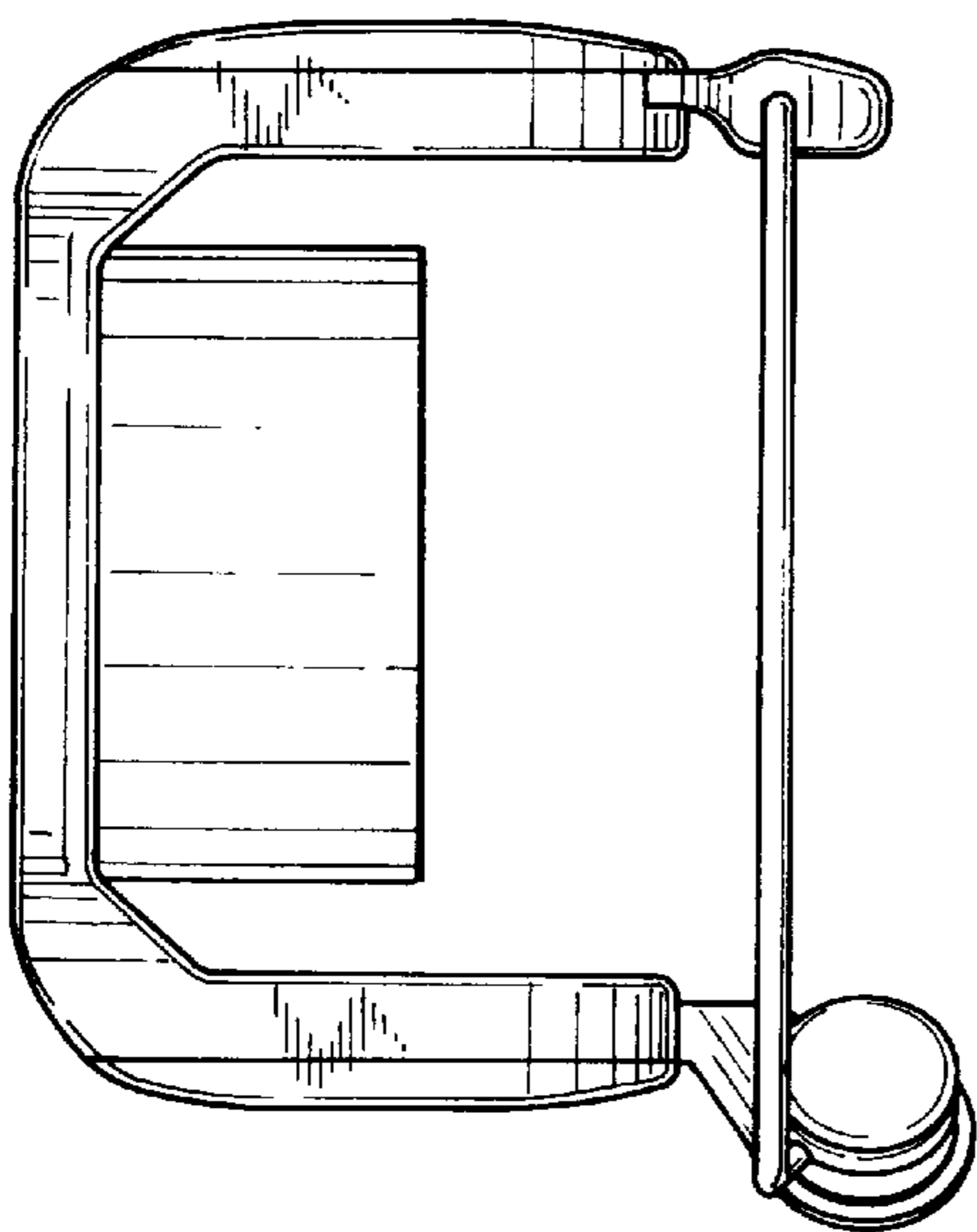

FIG. 7

