



US00D412176S

**United States Patent** [19]  
**Larson**

[11] **Patent Number: Des. 412,176**  
[45] **Date of Patent: \*\* Jul. 20, 1999**

[54] **FUEL SPILL COLLECTOR**  
[75] Inventor: **David K. Larson**, Sharonville, Ohio  
[73] Assignee: **Dover Corporation**, New York, N.Y.  
[\*\*] Term: **14 Years**  
[21] Appl. No.: **29/075,106**  
[22] Filed: **Aug. 8, 1997**

5,074,343 12/1991 Tyree, Jr. .  
5,103,877 4/1992 Sherwood et al. .  
5,168,908 12/1992 Boyum .  
5,186,358 2/1993 McVay .  
5,277,234 1/1994 Warstler .  
5,322,099 6/1994 Langlois .  
5,327,946 7/1994 Perkins .  
5,385,180 1/1995 Wittman .  
5,507,324 4/1996 Whitley, II et al. .  
5,590,698 1/1997 Whitley et al. .  
5,634,502 6/1997 Pierce .  
5,713,401 2/1998 Weeks ..... 141/202 X

**Related U.S. Application Data**

[30] **Foreign Application Priority Data**

Apr. 3, 1997 [CA] Canada ..... 1997-0819

[51] **LOC (6) Cl.** ..... **15-09**  
[52] **U.S. Cl.** ..... **D15/150**  
[58] **Field of Search** ..... D15/150-152;  
141/98, 384, 331, 340, 206

[56] **References Cited**

**U.S. PATENT DOCUMENTS**

D. 340,468 10/1993 Pollack et al. .  
D. 377,031 12/1996 Didier .  
D. 389,498 1/1998 Larson ..... D15/150  
4,003,415 1/1977 Lasater .  
4,166,485 9/1979 Wokas .

*Primary Examiner*—Antoine Duval Davis  
*Attorney, Agent, or Firm*—Dinsmore & Shohl LLP

[57] **CLAIM**

The ornamental design for a fuel spill collector, as shown and described.

**DESCRIPTION**

FIG. 1 is a side perspective view thereof;  
FIG. 2 is a front view thereof;  
FIG. 3 is a bottom view thereof;  
FIG. 4 is a top view thereof;  
FIG. 5 is a side view thereof, the opposite side view thereof being the mirror image of FIG. 5; and,  
FIG. 6 is a back view thereof.

**1 Claim, 2 Drawing Sheets**

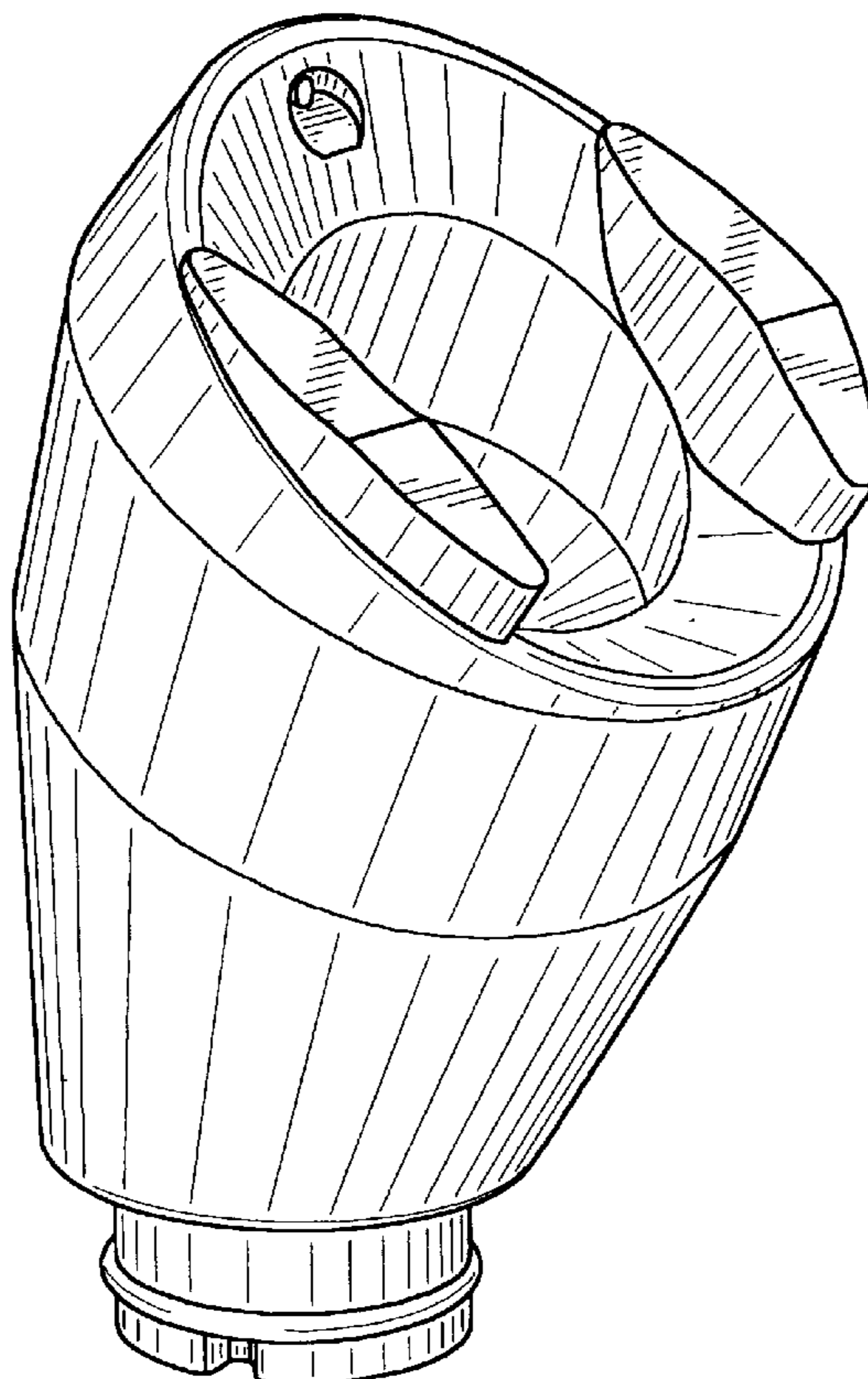

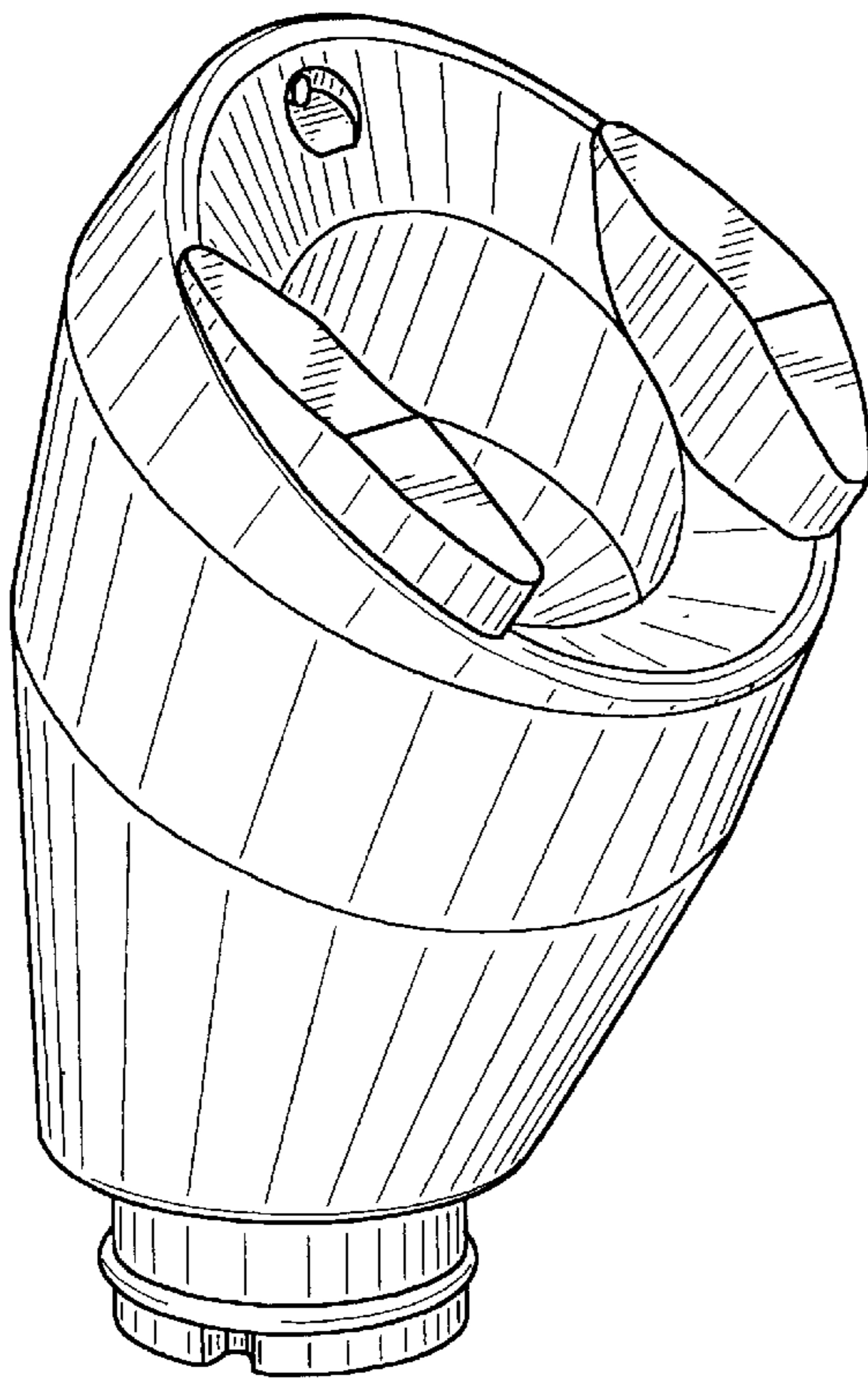

FIG. 1

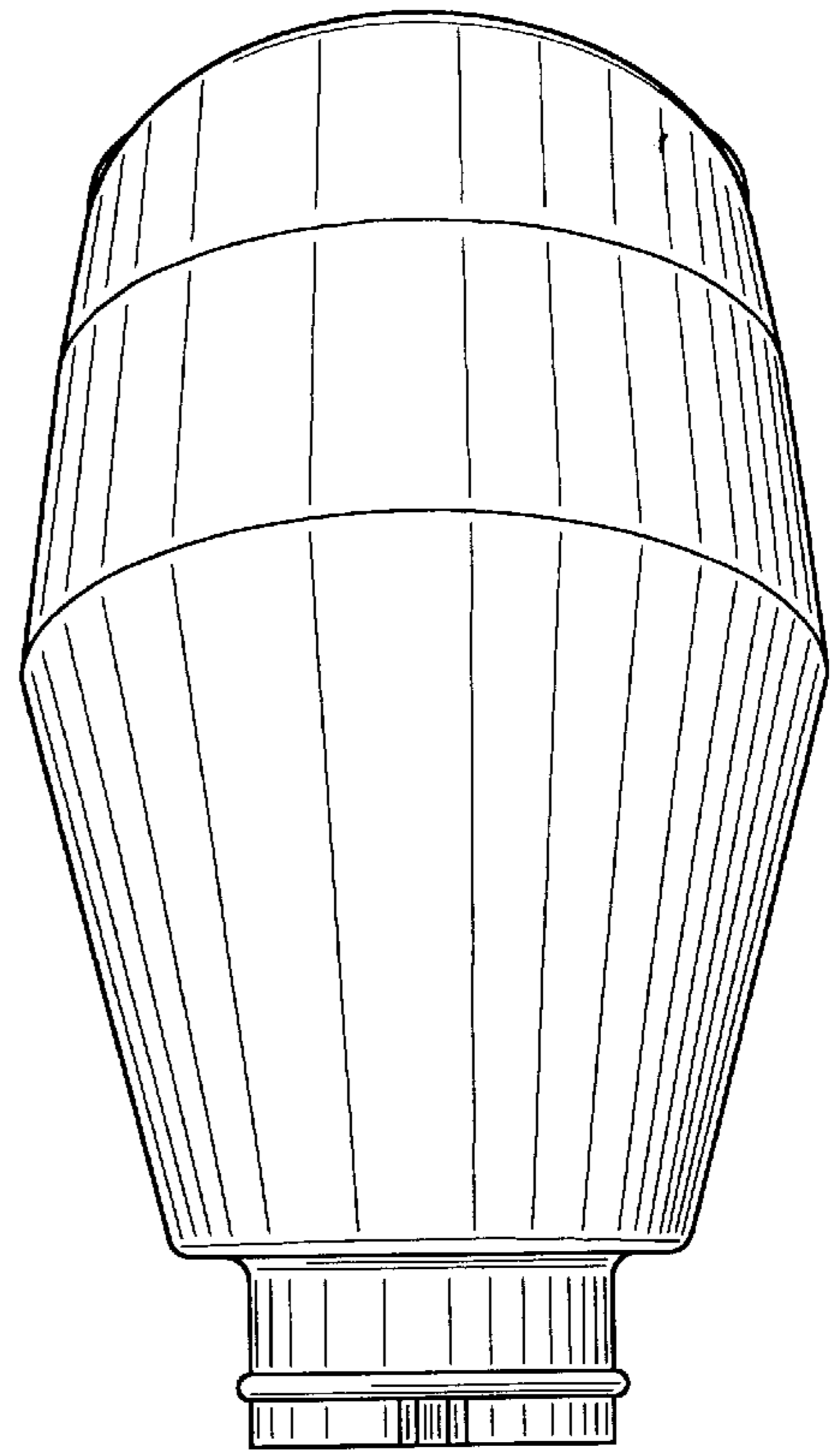

FIG. 2

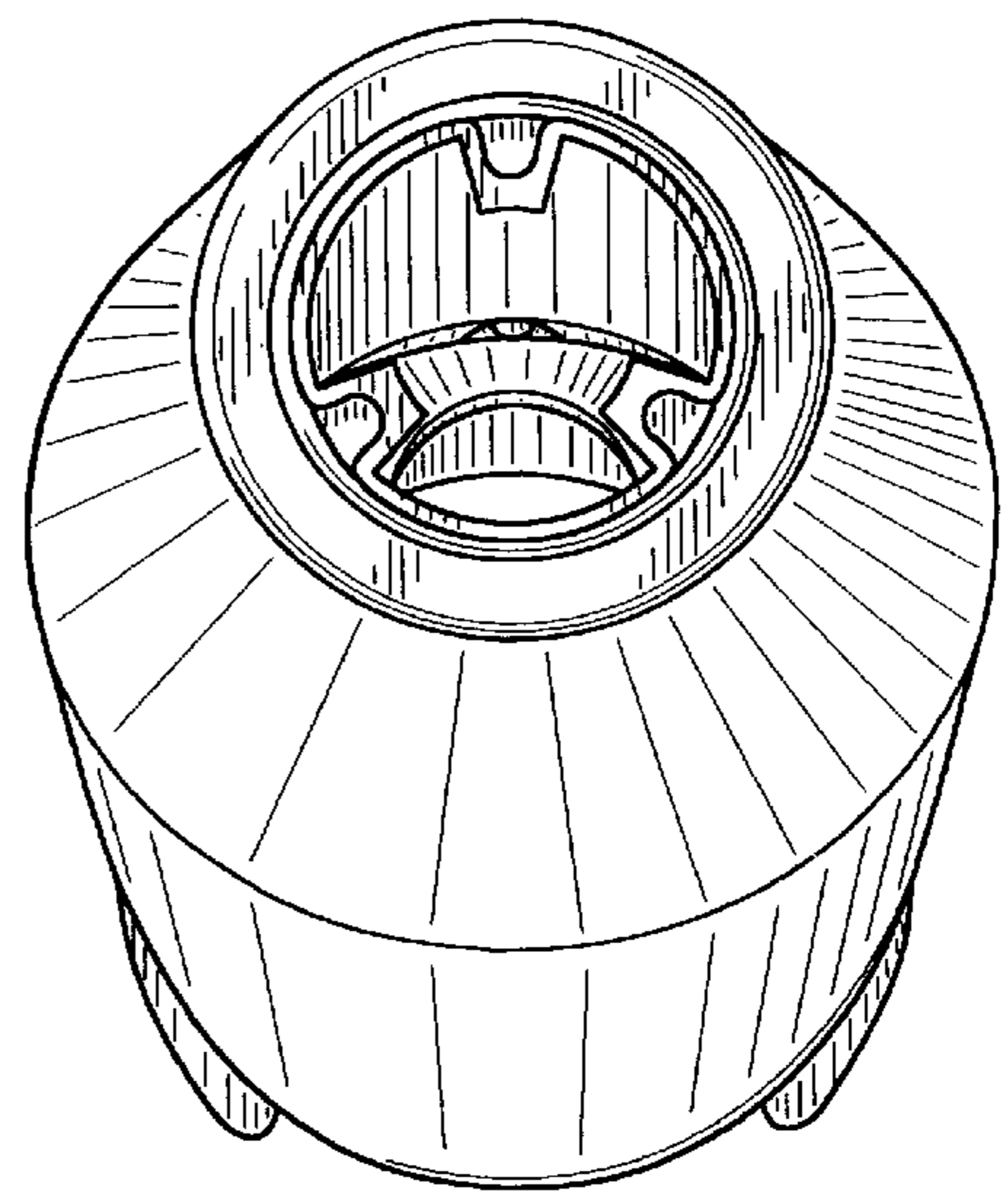

FIG. 3

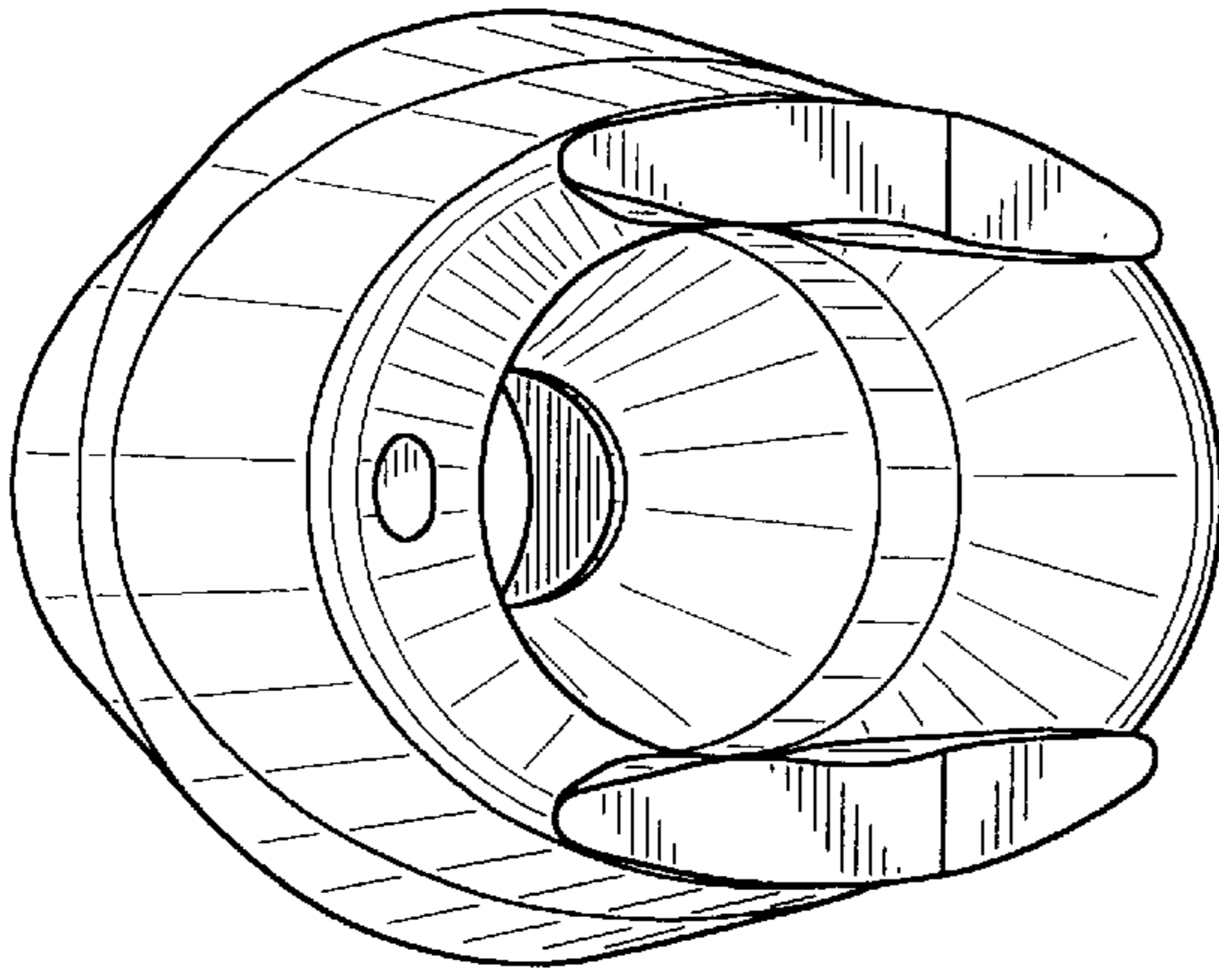

FIG. 4

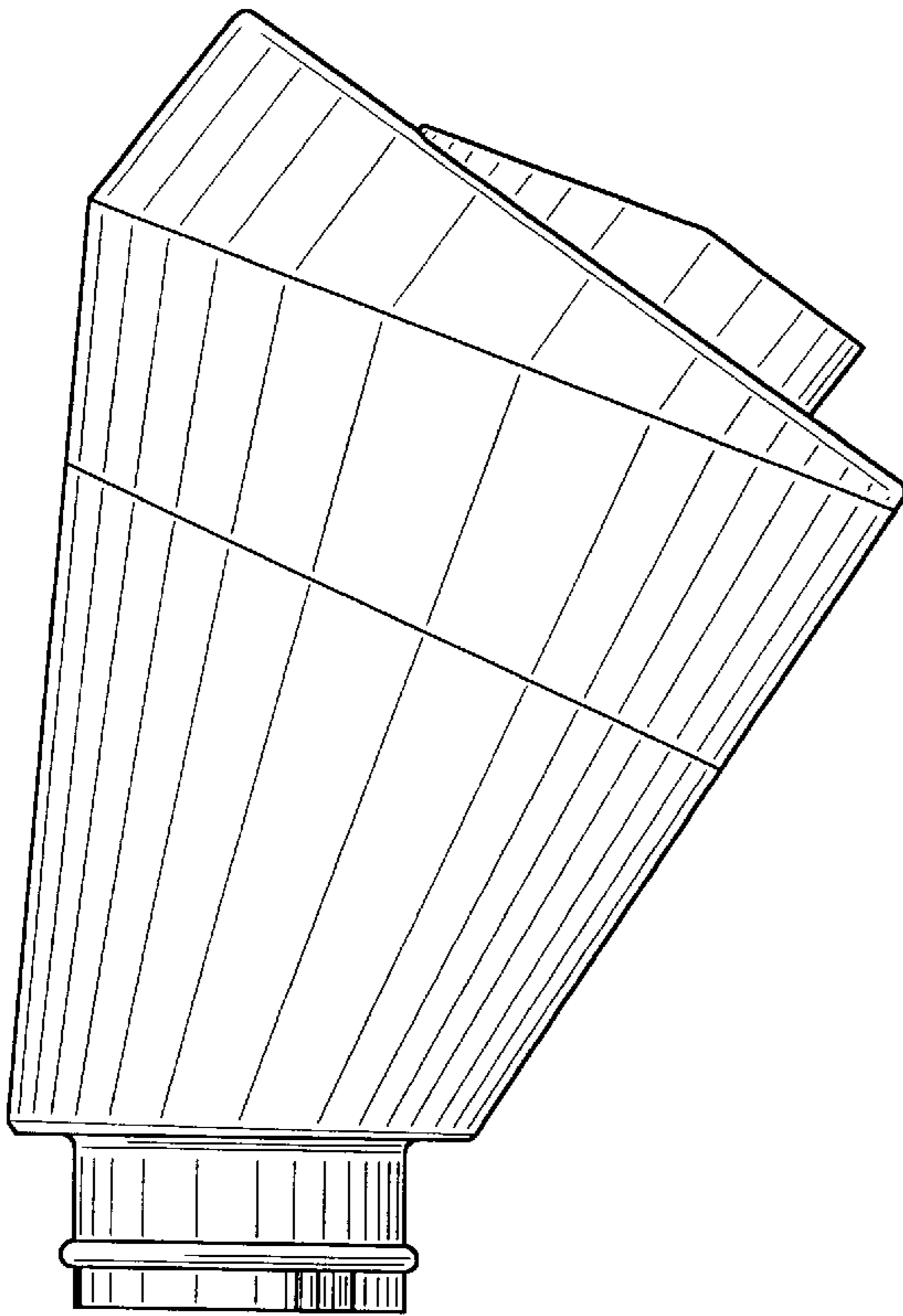

FIG. 5

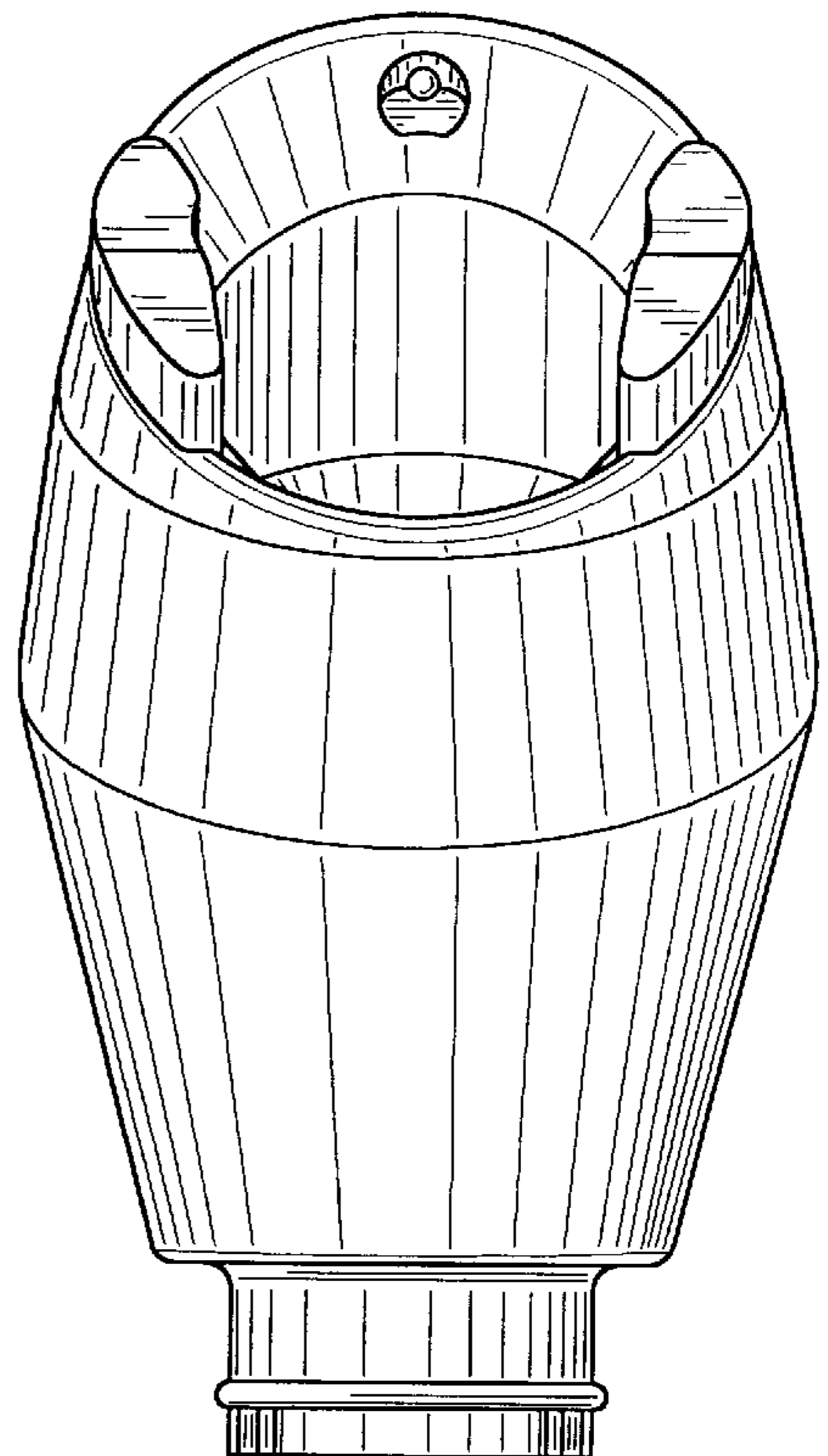

FIG. 6