



US00D412145S

United States Patent [19] Bangle

[11] **Patent Number: Des. 412,145**

[45] **Date of Patent: ** Jul. 20, 1999**

[54] **EXTERIOR FACING SURFACE CONFIGURATION OF A HOOD FOR AN AUTOMOBILE**

[75] Inventor: **Christopher Edward Bangle**, Gilching, Germany

[73] Assignee: **Bayerische Motoren Werke Aktiengesellschaft**, Munich, Germany

[**] Term: **14 Years**

[21] Appl. No.: **29/082,212**

[22] Filed: **Jan. 16, 1998**

[30] **Foreign Application Priority Data**

Jul. 16, 1997 [DE] Germany 97 06 695

[51] **LOC (6) Cl.** **12-16**

[52] **U.S. Cl.** **D12/173**

[58] **Field of Search** D12/173, 90-92; 180/69.21, 69.2, 69.22, 69.25

[56] **References Cited**

U.S. PATENT DOCUMENTS

- D. 306,152 2/1990 Guelfi et al. D12/173
- D. 374,202 10/1996 Nayashima D12/173
- D. 391,540 3/1998 Horbury D12/173
- D. 392,220 3/1998 Haussmann D12/91
- D. 396,432 7/1998 Syrung D12/91
- D. 399,463 10/1998 Grabo et al. D12/173

Primary Examiner—Melody M. Brown

Attorney, Agent, or Firm—Evenson, McKeown, Edwards & Lenahan, PLLC

[57] **CLAIM**

The ornamental design for an exterior facing surface configuration of a hood for an automobile, as shown and described.

DESCRIPTION

FIG. 1 is a front view of an exterior facing surface configuration of a hood for an automobile according to my novel design;

FIG. 2 is a top view of an exterior facing surface configuration of a hood for an automobile according to my novel design;

FIG. 3 is a side view from the left of an exterior facing surface configuration of a hood for an automobile according to my novel design, which is a mirror image of the side view from the right;

FIG. 4 is a rear view of an exterior facing surface configuration of a hood for an automobile according to my novel design;

FIG. 5 is a perspective view from the front right of an exterior facing surface configuration of a hood for an automobile according to my novel design; and,

FIG. 6 is a perspective view from the rear right of an exterior facing surface configuration of a hood for an automobile according to my novel design.

The broken lines shown in all drawing views are for illustrative purposes only and form no part of the claimed design.

1 Claim, 6 Drawing Sheets

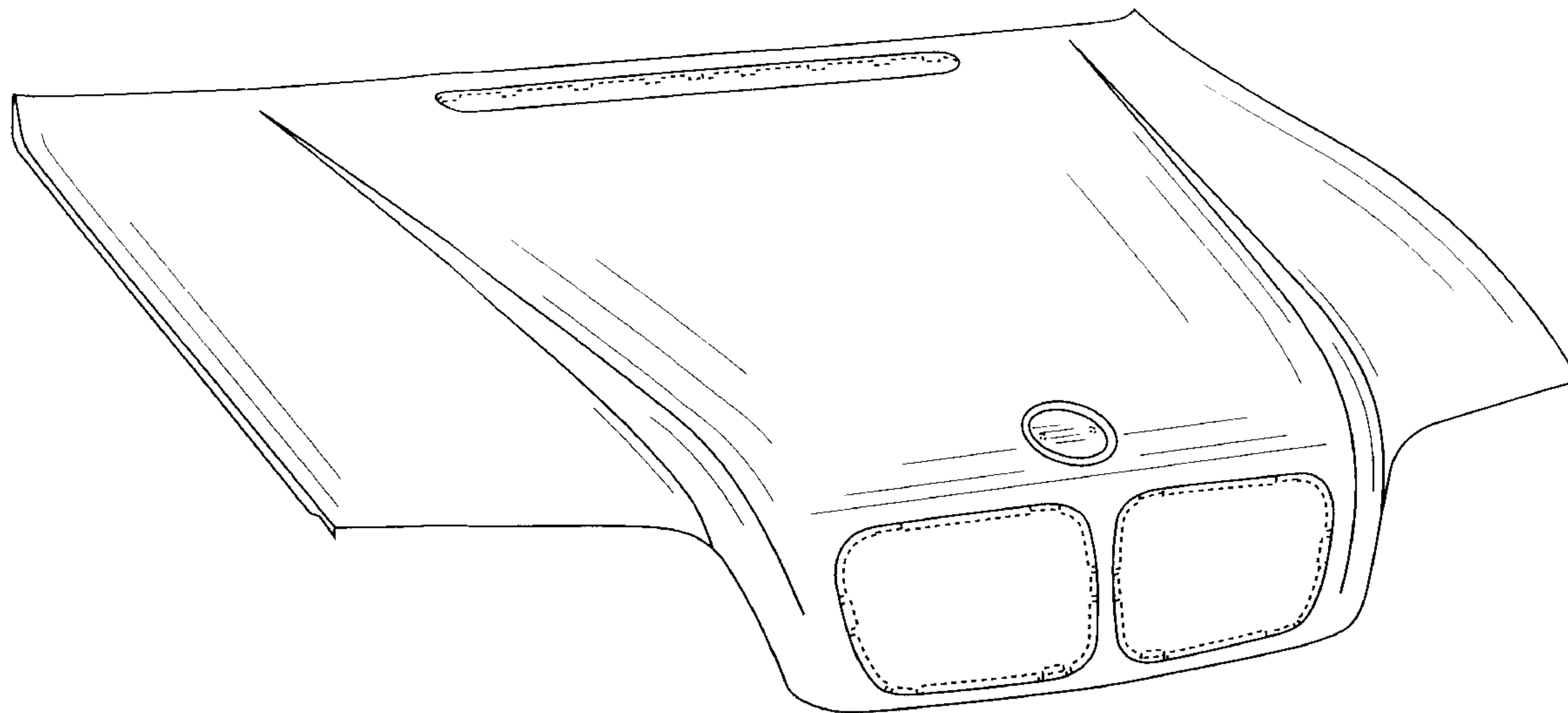

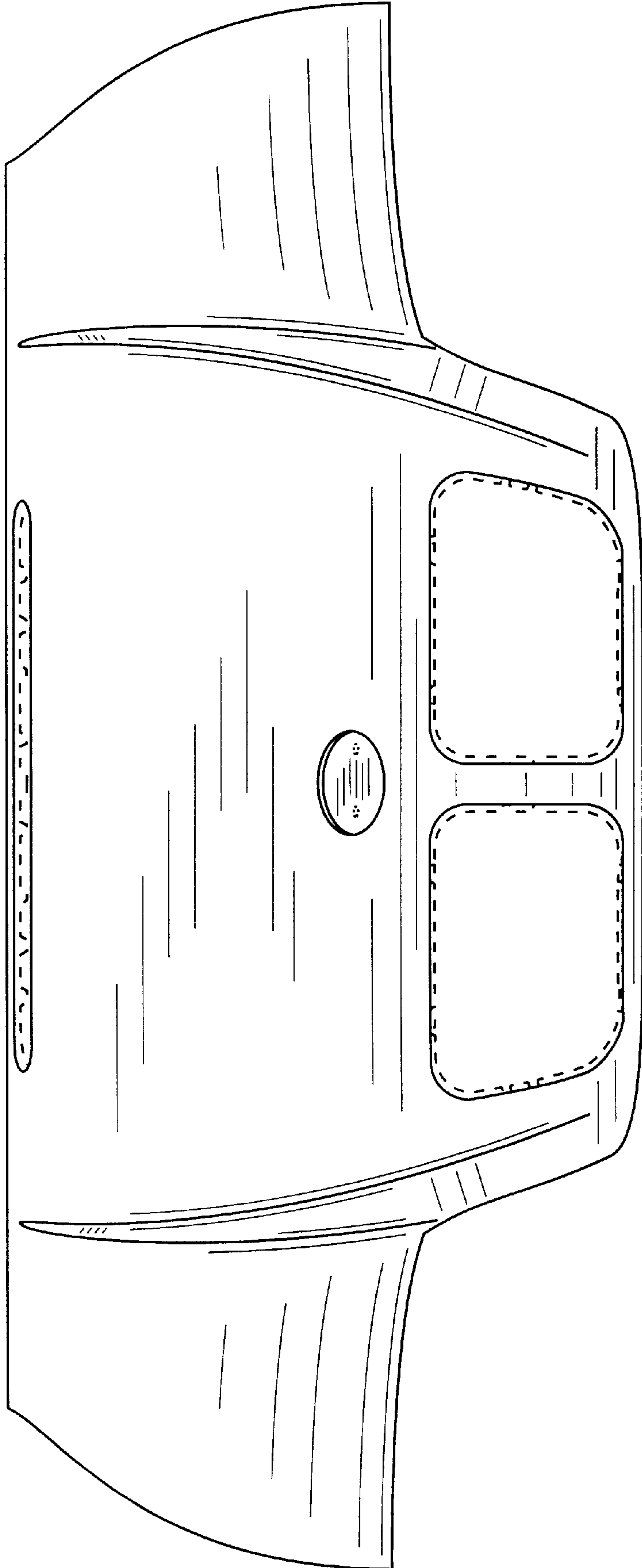

FIG. 1

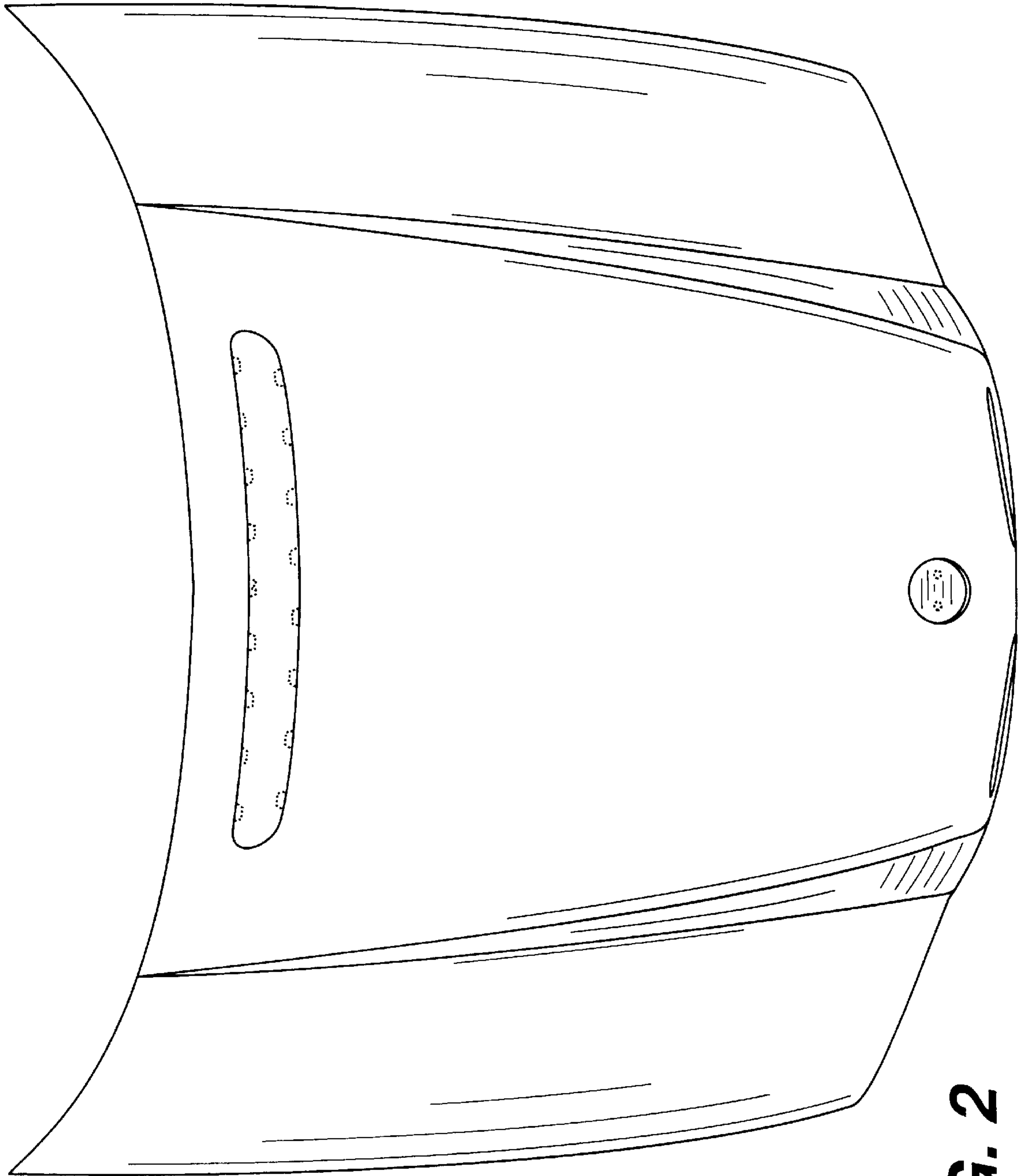

FIG. 2

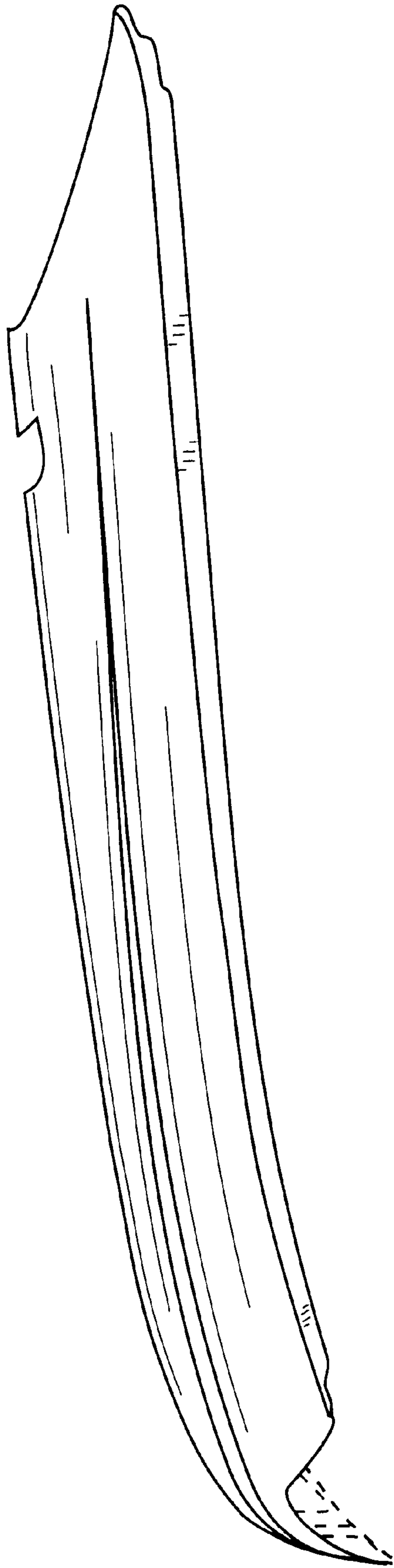

FIG. 3

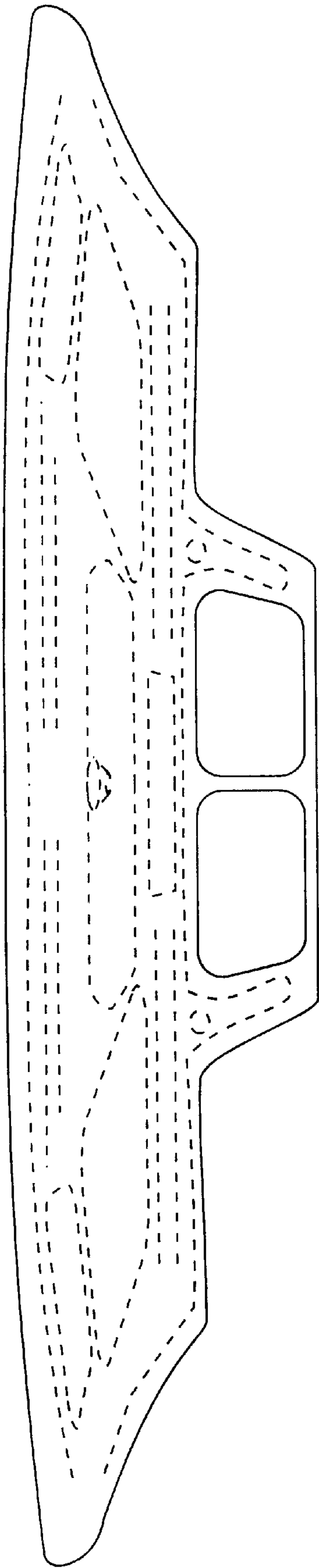

FIG. 4

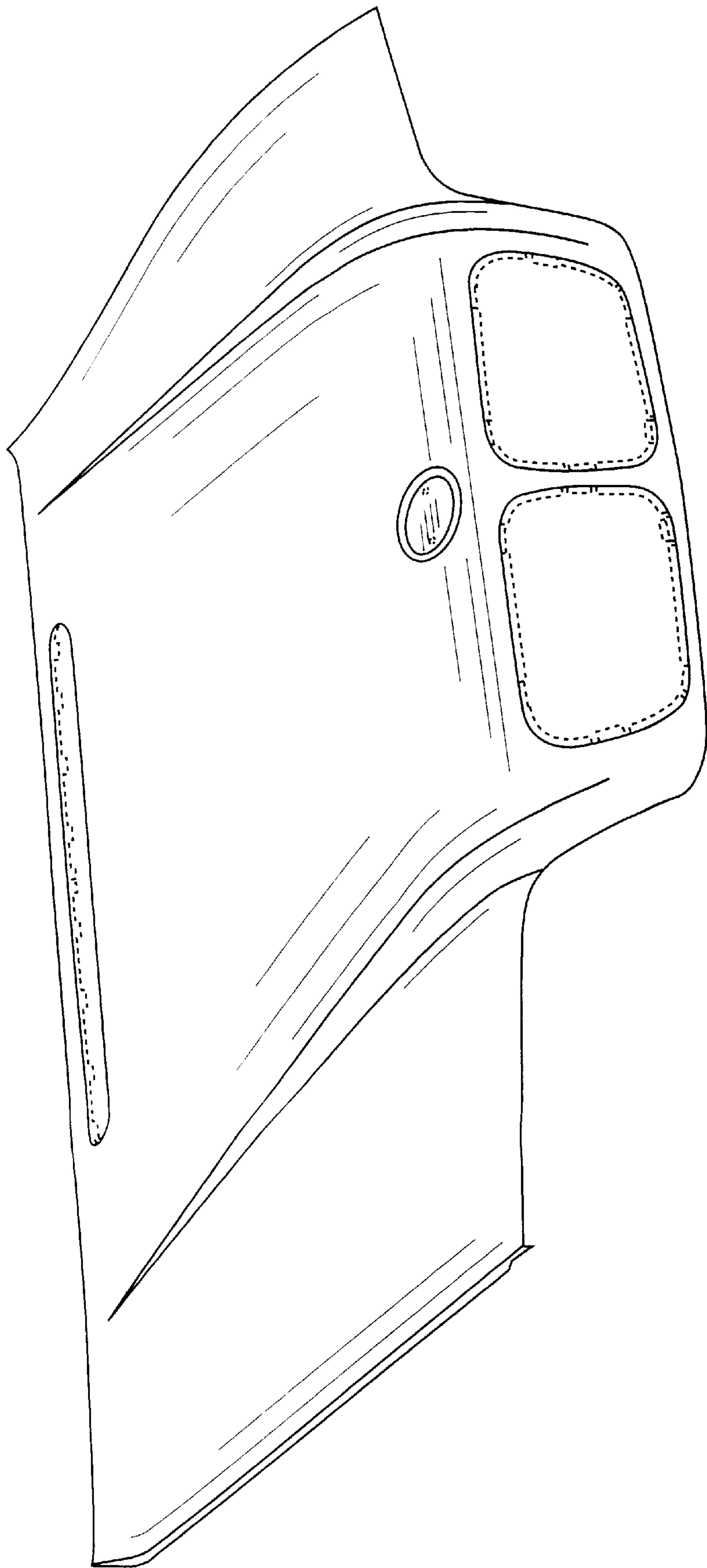

FIG. 5

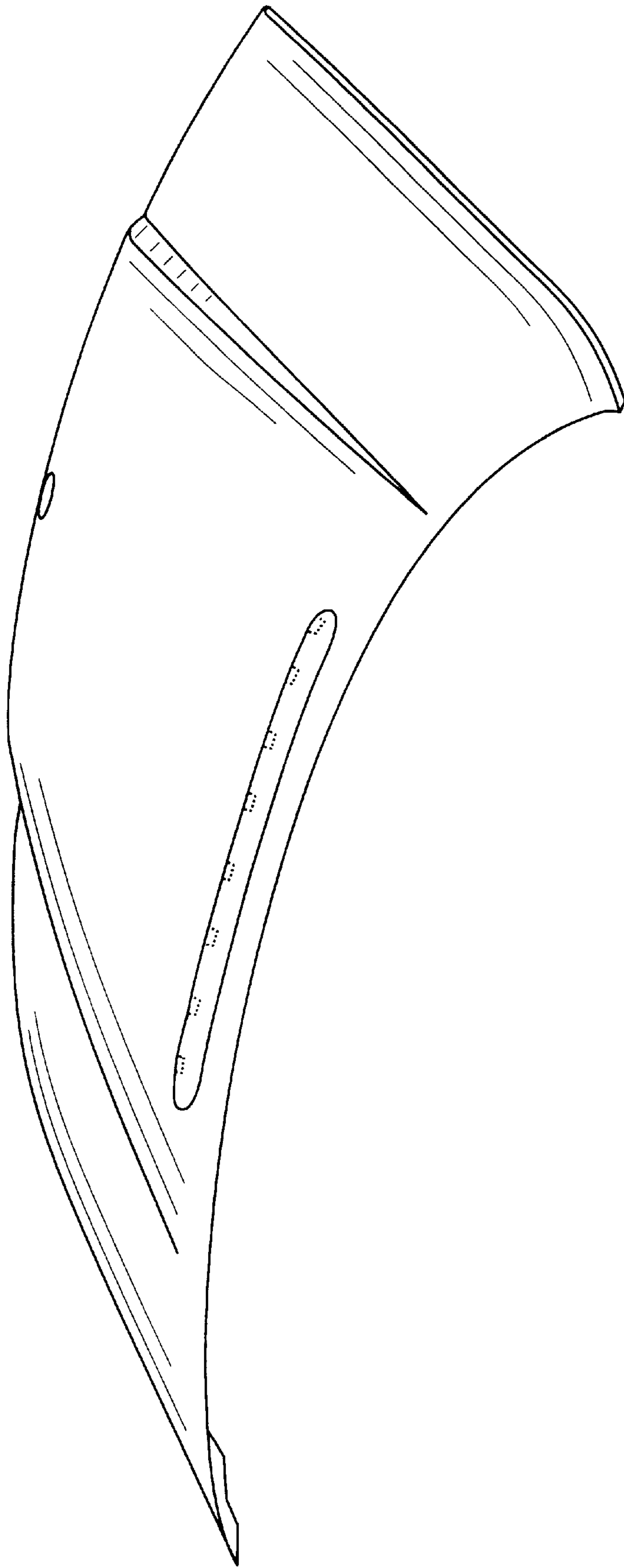

FIG. 6