



US00D412140S

**United States Patent** [19]  
**Garven, Jr.**

[11] **Patent Number: Des. 412,140**  
[45] **Date of Patent: \*\* Jul. 20, 1999**

[54] **FORK FOR SUPPORTING A WHEELCHAIR  
CASTER**

5,568,671 10/1996 Harris et al. .... 16/18 R  
5,813,090 9/1998 Miles ..... 16/37

[75] Inventor: **Douglas M. Garven, Jr.**, Boulder,  
                  **Colo.**

*Primary Examiner*—Kay H. Chin  
*Attorney, Agent, or Firm*—MacMillan, Sobanski & Todd,  
LLC

[73] Assignee: **Sunrise Medical HHG Inc.**, Longmont,  
                  **Colo.**

[57] **CLAIM**

[\*\*] Term: **14 Years**

The ornamental design for a fork for supporting a wheel-  
chair caster, as shown and described.

[21] Appl. No.: **29/093,691**

**DESCRIPTION**

[22] Filed: **Sep. 17, 1998**

[51] **LOC (6) Cl.** ..... **12-12**

[52] **U.S. Cl.** ..... **D12/133; D8/375**

[58] **Field of Search** ..... **D12/128-133;**  
                                  **D8/375, 382; 16/18 R, 19, 20, 21, 22, 30,**  
                                  **31 R, 31 A, 40, 37; 280/250.1, 304.1**

FIG. 1 is a rear perspective view of a fork for supporting a  
wheelchair caster showing my new design;  
FIG. 2 is a front elevational view thereof;  
FIG. 3 is a right side view thereof with the left side view  
being a mirror image thereof;  
FIG. 4 is a rear elevational view thereof;  
FIG. 5 is a top plan view thereof; and,  
FIG. 6 is a bottom plan view thereof.  
The broken line in FIG. 1 showing the caster stem and caster  
is for illustrative purposes only and forms no part of the  
claimed design.

[56] **References Cited**

**U.S. PATENT DOCUMENTS**

4,897,895 2/1990 Wang ..... 16/20  
5,479,677 1/1996 Chong ..... 16/21

**1 Claim, 2 Drawing Sheets**

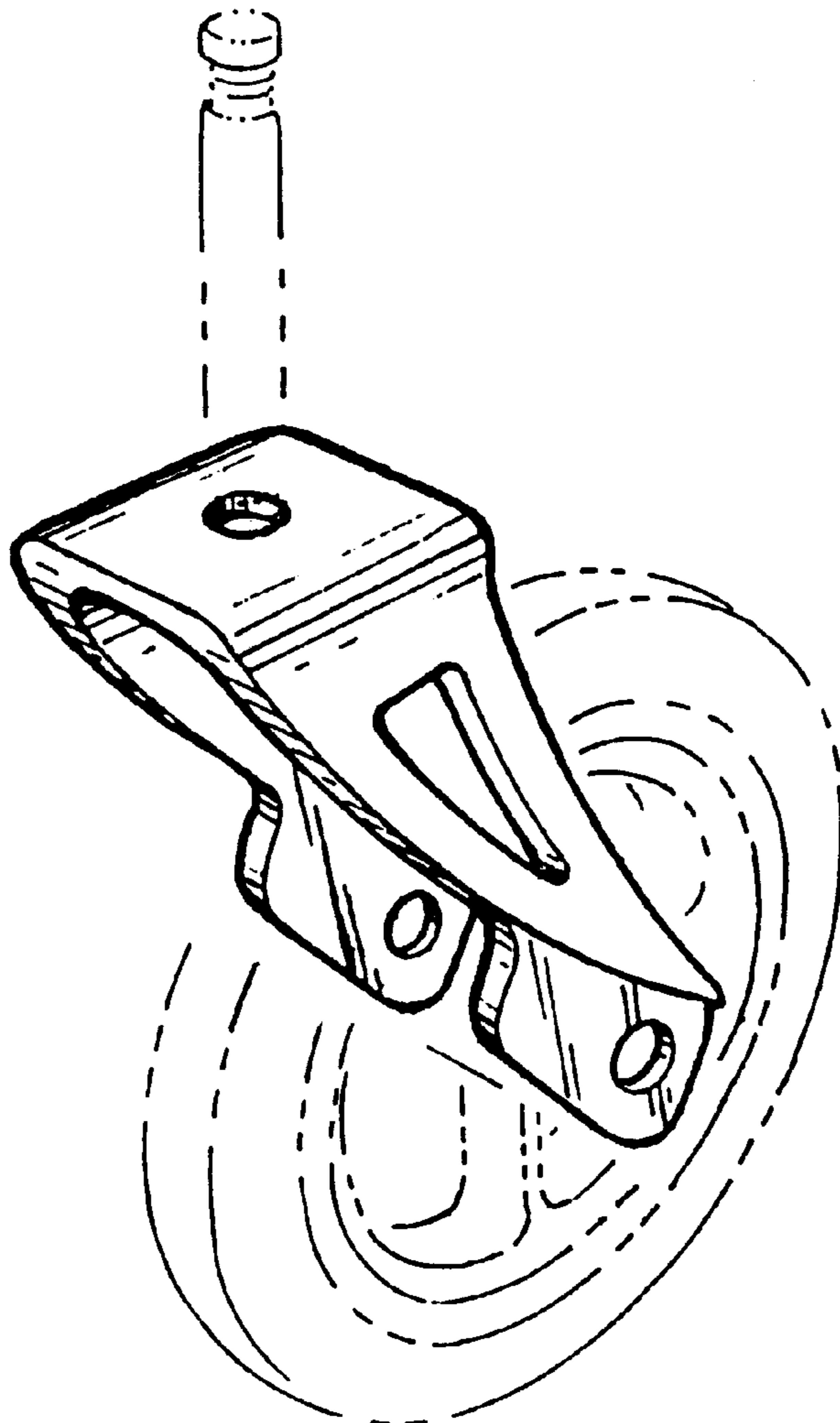

FIG. 1

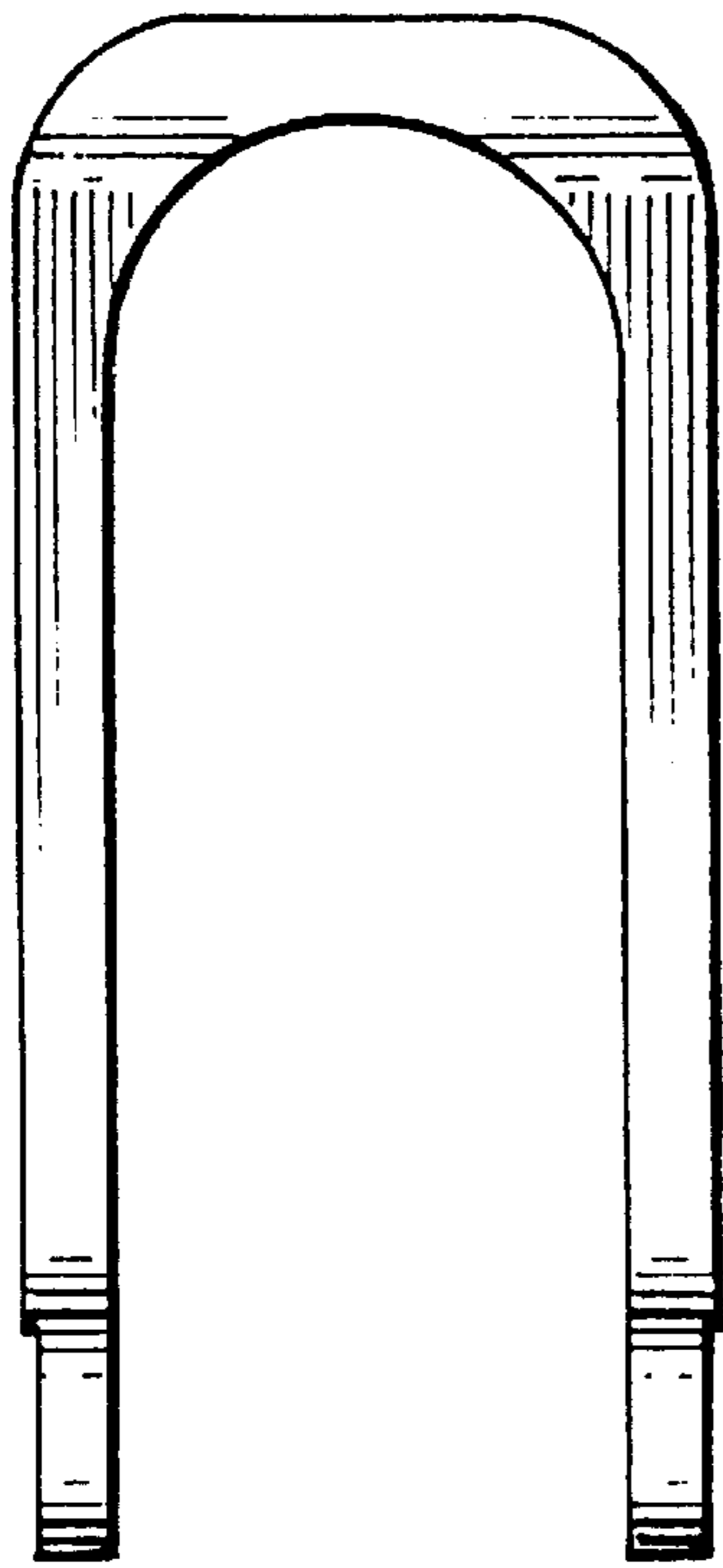
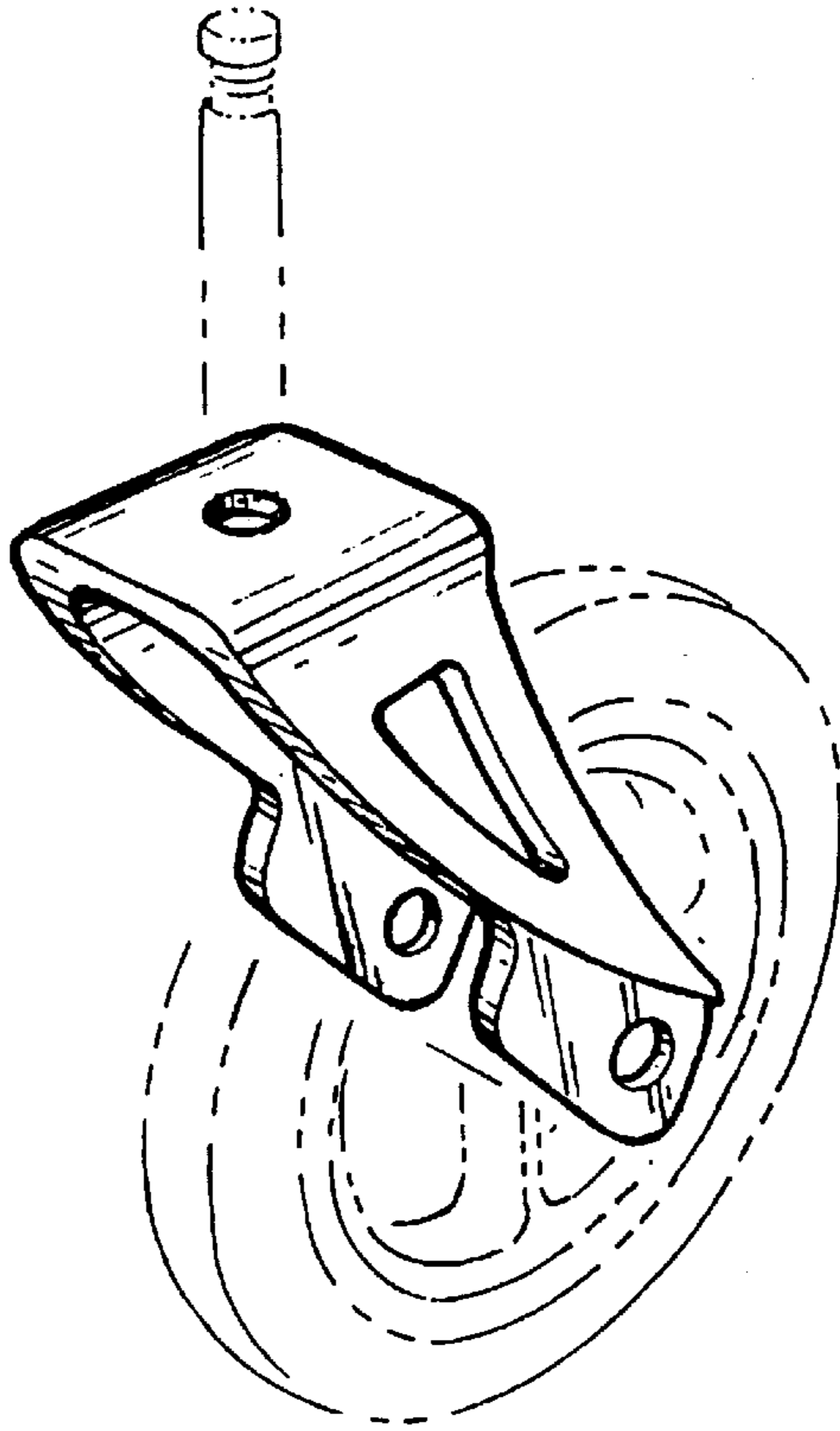

FIG. 2

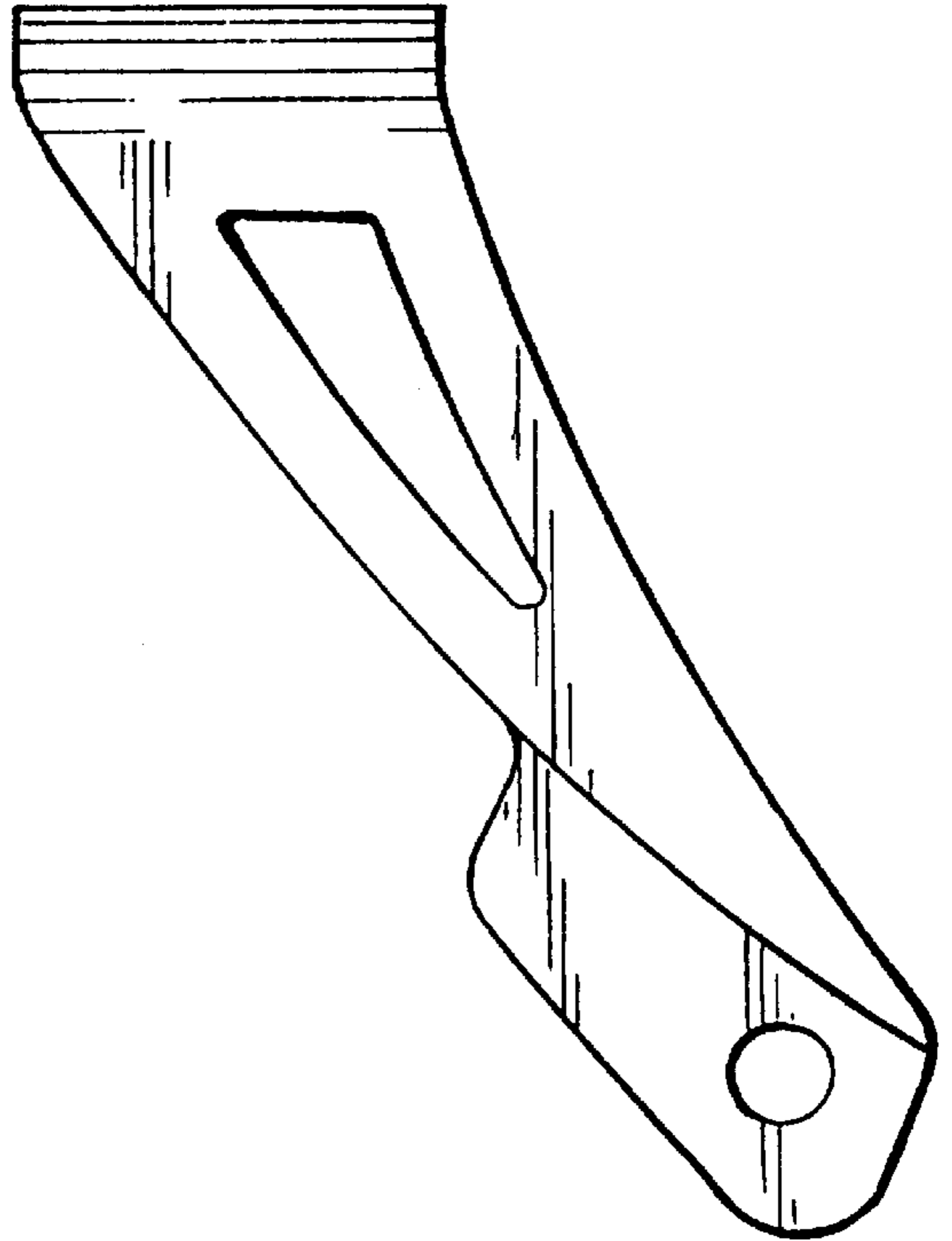

FIG. 3

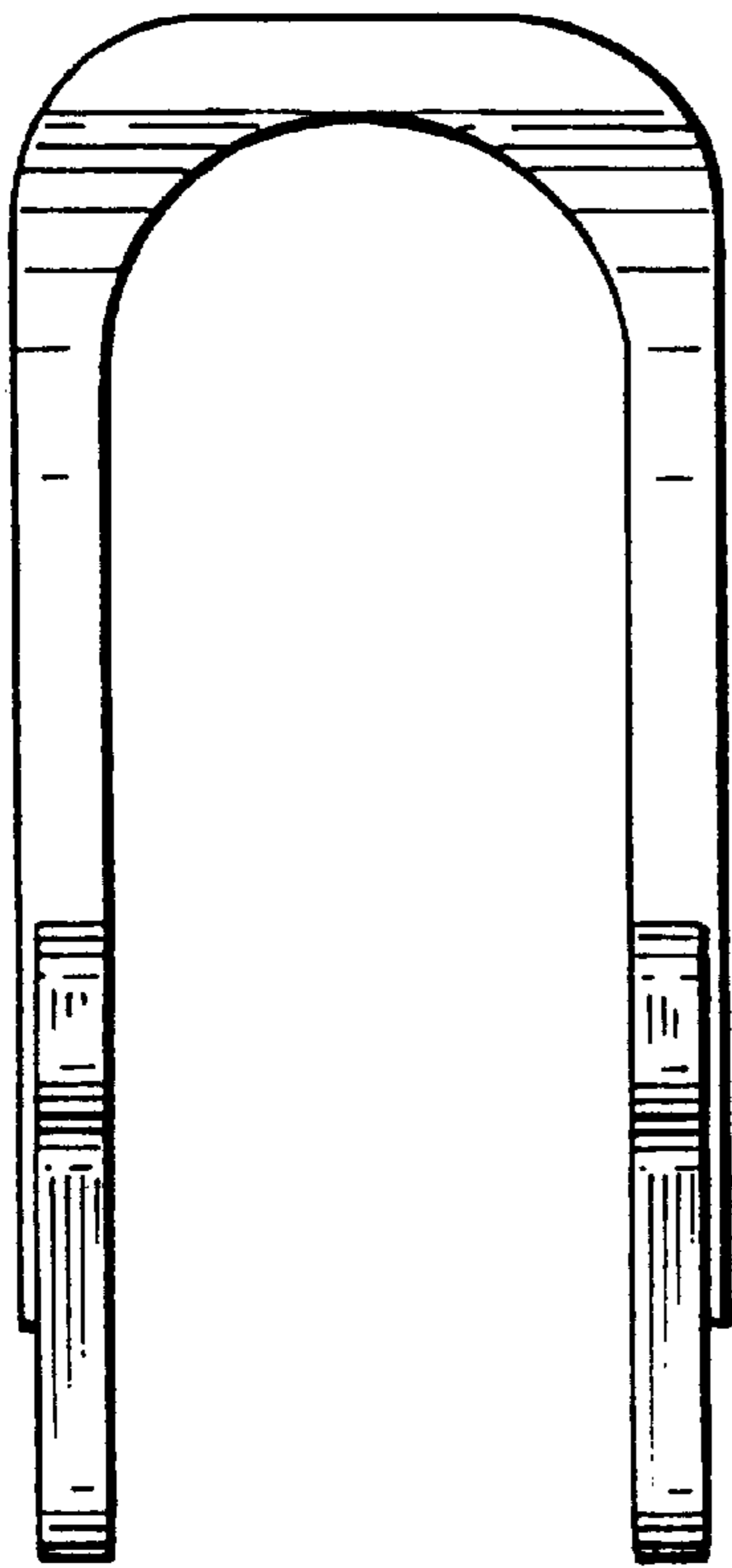

FIG. 4

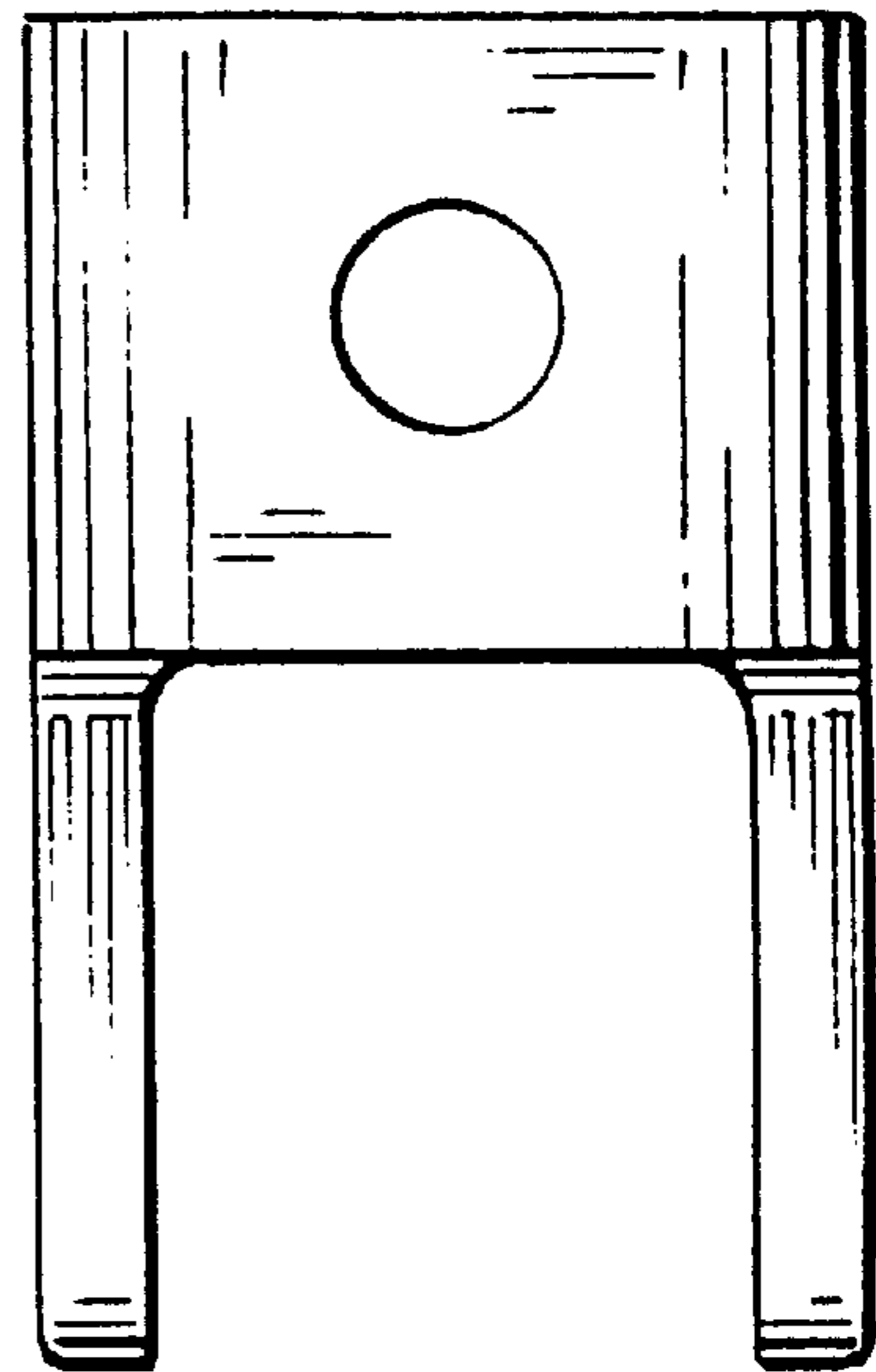

FIG. 5

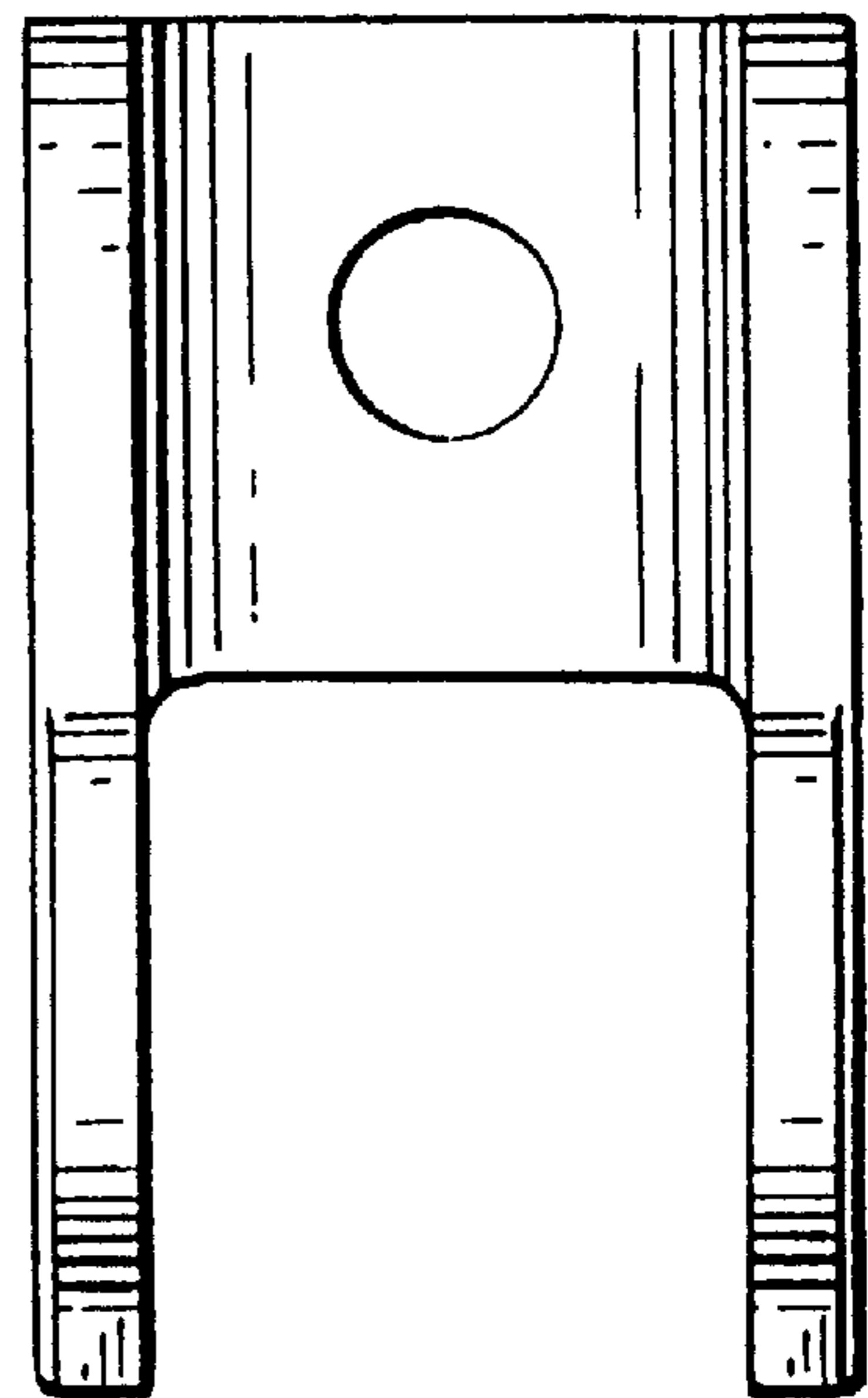

FIG. 6