



US00D412113S

United States Patent [19]

[11] Patent Number: **Des. 412,113**

Josephs

[45] Date of Patent: **** Jul. 20, 1999**

[54] **PACKAGING FOR SLIPPERS AND SUNGLASSES**

[76] Inventor: **Ronald H. Josephs**, 4122 Clarinda Dr., Tarzana, Calif. 91356

[**] Term: **14 Years**

[21] Appl. No.: **29/098,030**

[22] Filed: **Dec. 21, 1998**

[51] **LOC (6) Cl.** **09-07**

[52] **U.S. Cl.** **D9/415; D9/337**

[58] **Field of Search** D9/414, 415, 418, D9/337; D3/265, 266; D16/309, 300; D2/916; 36/11.5; 206/278, 8, 806, 5, 348, 316.1, 461; 224/909, 933

4,718,546	1/1988	Kolton et al.	206/278 X
4,765,467	8/1988	Kolton et al.	206/278 X
5,141,104	8/1992	Morrow et al.	206/5
5,279,420	1/1994	Rodgers	206/806 X
5,423,505	6/1995	David	206/806 X
5,650,836	7/1997	Strauss et al.	206/5 X

Primary Examiner—Prabhakar Deshmukh
Attorney, Agent, or Firm—Timothy Thut Tyson

[57] CLAIM

The ornamental design for a packaging for slippers and sunglasses, as shown.

DESCRIPTION

FIG. 1 is a front elevation view of a packaging for slippers and sunglasses showing my new design;
FIG. 2 is a right side elevation view thereof;
FIG. 3 is a top plan view thereof;
FIG. 4 is a rear elevation view thereof;
FIG. 5 is a left side elevation view thereof; and,
FIG. 6 is a bottom plan view thereof.

[56] References Cited

U.S. PATENT DOCUMENTS

D. 168,426	12/1952	Siegel	D9/337 X
D. 249,468	9/1978	Carroll	D9/415
D. 349,239	8/1994	Steenland	D9/415

1 Claim, 2 Drawing Sheets

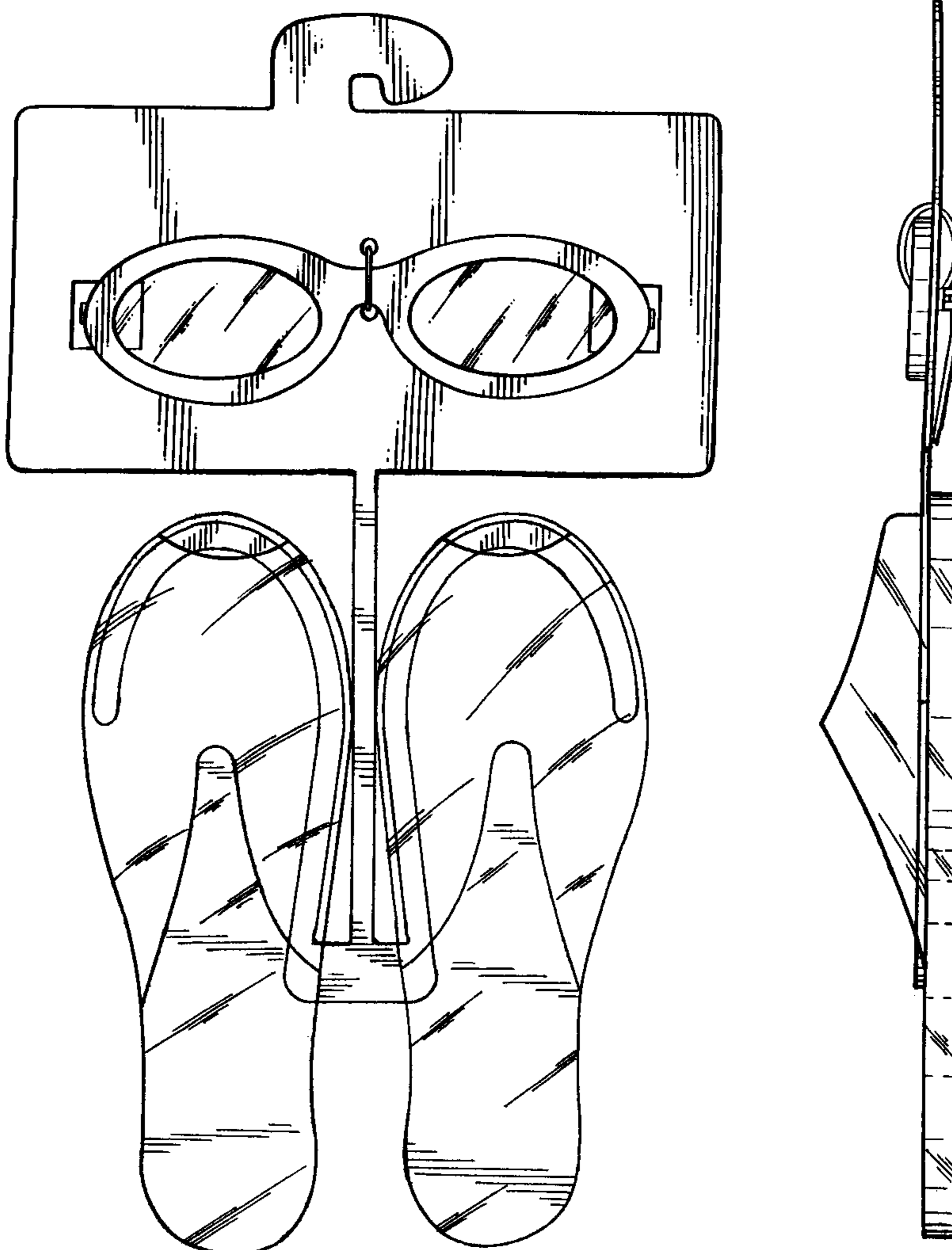

FIG. 1

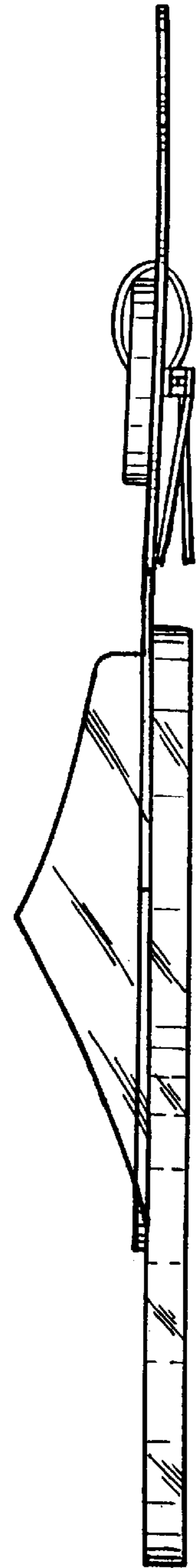
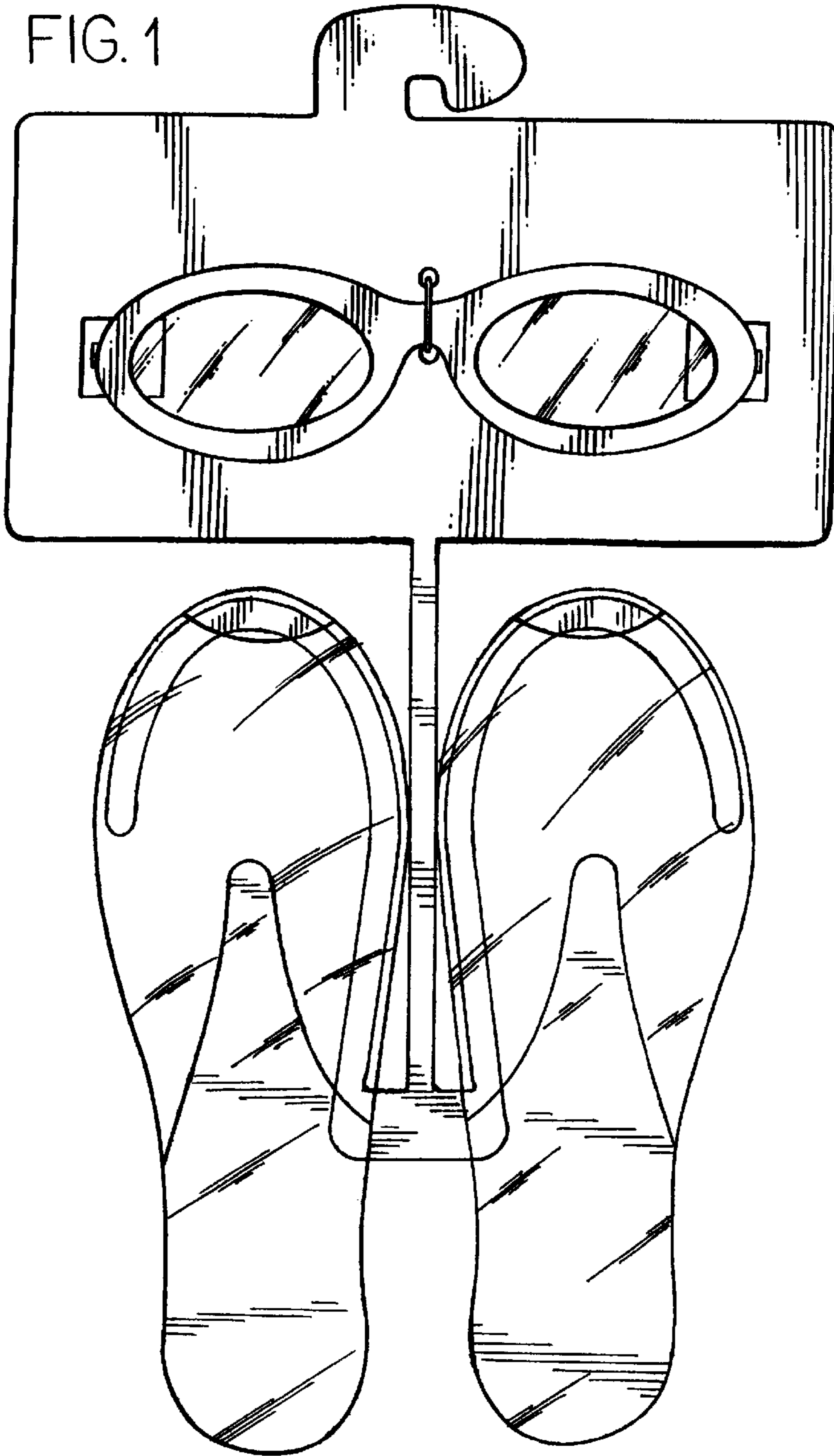

FIG. 2

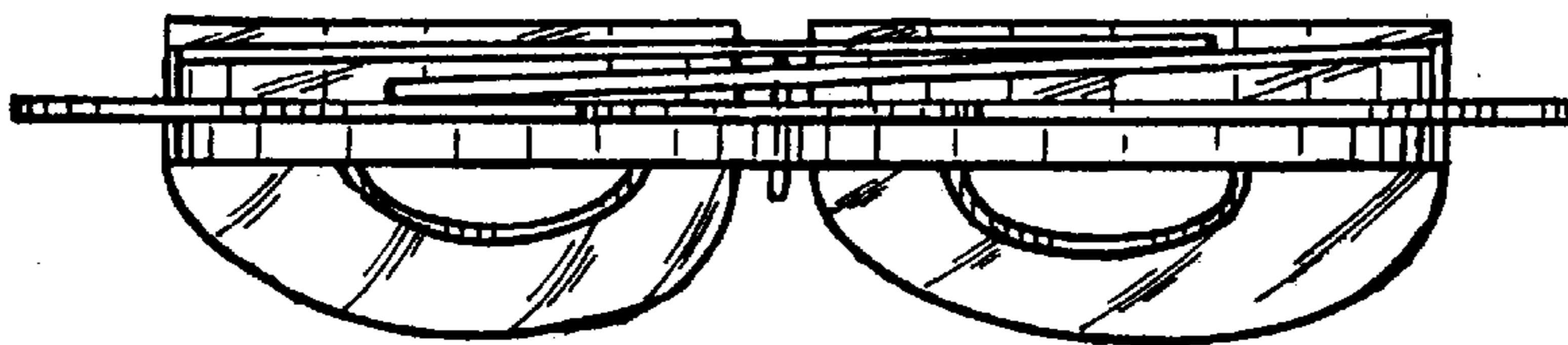

FIG. 3

FIG. 4

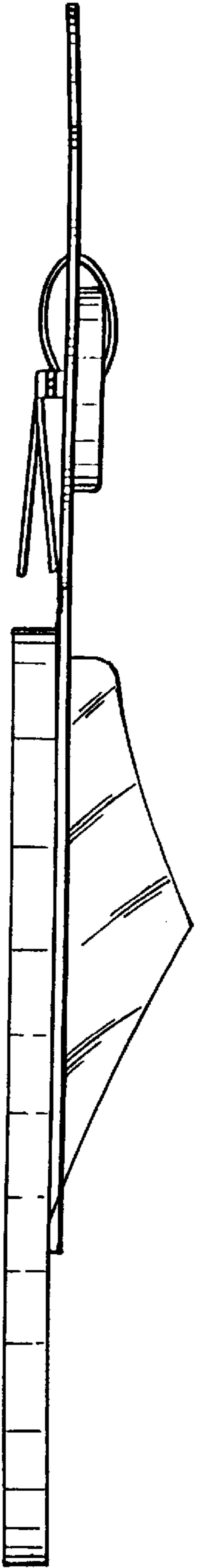
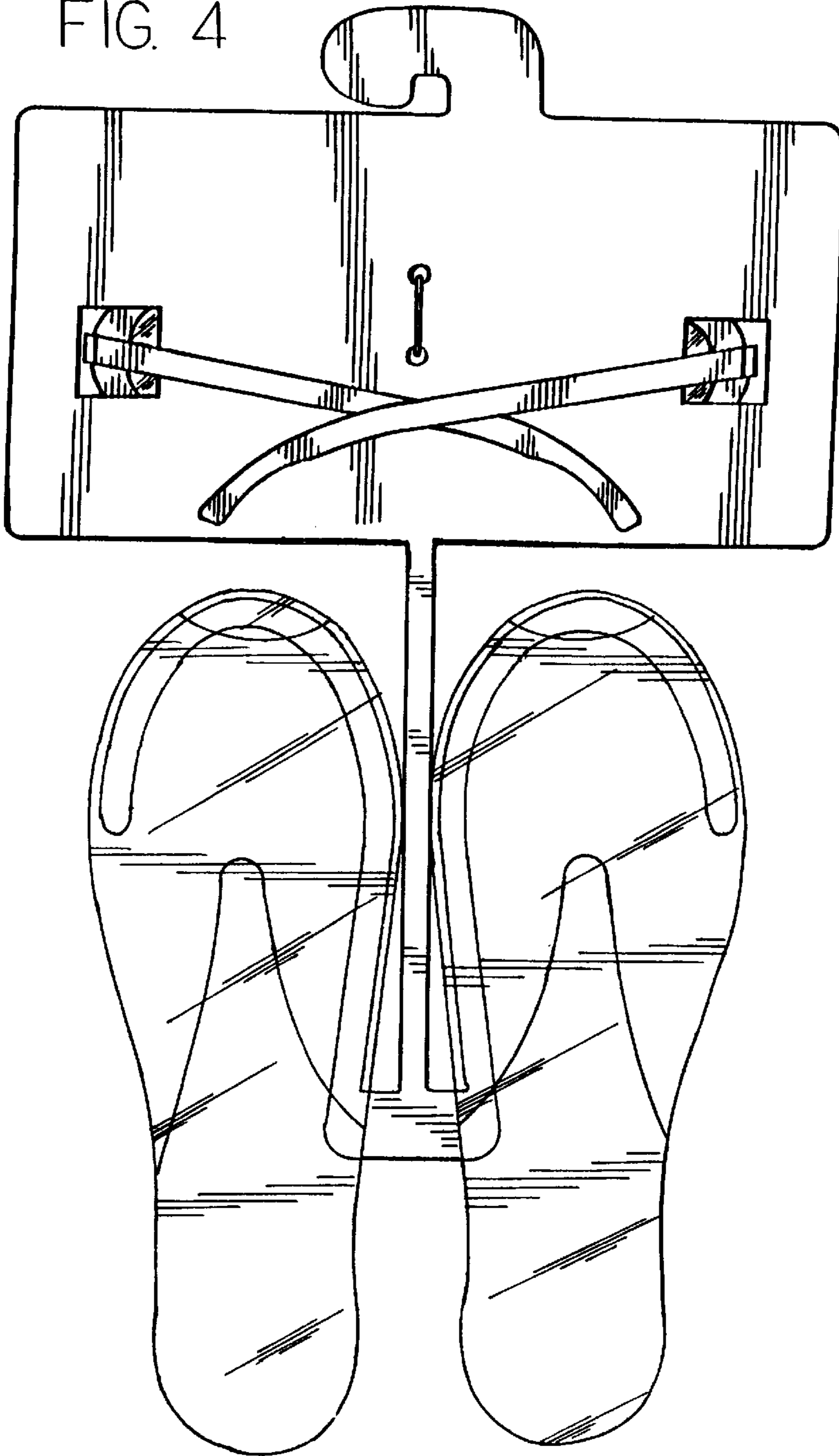

FIG. 5

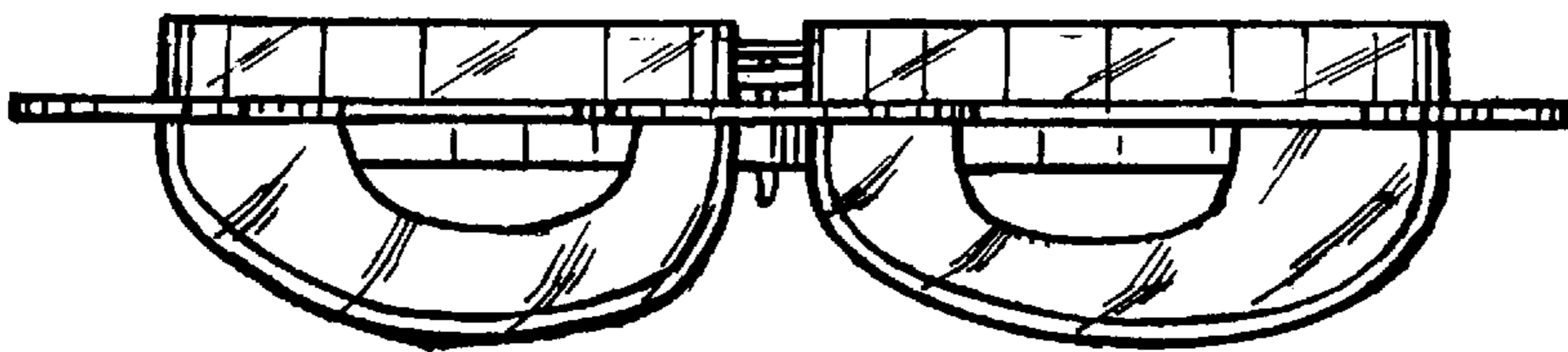

FIG. 6