



US00D412058S

**United States Patent** [19]  
**Edworthy**

[11] **Patent Number: Des. 412,058**

[45] **Date of Patent: \*\* Jul. 20, 1999**

[54] **KEY RING PENDANT**

[76] Inventor: **Peter John Edworthy**, 99 Seneca Drive, Ancaster, Ontario, Canada, L9G 3B7

[\*\*] Term: **14 Years**

[21] Appl. No.: **29/092,132**

[22] Filed: **Aug. 13, 1998**

[30] **Foreign Application Priority Data**

Feb. 17, 1998 [CA] Canada ..... 1998-0360

[51] **LOC (6) Cl.** ..... **03-01**

[52] **U.S. Cl.** ..... **D3/208**

[58] **Field of Search** ..... D3/207-211; D11/1-25, D11/27, 81, 93; D8/395, 499; D12/114, 123, 127; 63/1.1, 2, 3, 4; 59/78-95; 70/45.6 R-460; 24/3.6

[56] **References Cited**

**U.S. PATENT DOCUMENTS**

- D. 25,501 5/1896 Wood ..... D11/81
- D. 246,830 1/1978 Lossini ..... D11/12
- D. 247,103 1/1978 Lossini ..... D11/12
- D. 294,144 2/1988 McClure ..... D11/81
- D. 338,102 8/1993 McGuire et al. .... D3/207

- D. 358,355 5/1995 Fernandez ..... D11/3
- D. 385,415 10/1997 Turbide ..... D3/207
- D. 440,468 11/1998 Norman ..... D11/81

*Primary Examiner*—Ralf Seifert  
*Attorney, Agent, or Firm*—Patrick J. Hofbauer

[57] **CLAIM**

The ornamental design for a key ring pendant, as shown and described.

**DESCRIPTION**

FIG. 1 is a perspective view of the key ring pendant showing my new design in a closed configuration.

FIG. 2 is a top view the design shown in FIG. 1.

FIG. 3 is an elevational view of a first end of the design shown FIG. 1.

FIG. 4 is an elevational view of the front of the design shown FIG. 1 .

FIG. 5 is an elevational view of a second end of the design shown FIG. 1.

FIG. 6 is a bottom view of the design shown FIG. 1.

FIG. 7 is an inverted elevational view of the back of the design shown FIG. 1; and,

FIG. 8 is a perspective view of the key ring pendant showing my new design in an open configuration.

**1 Claim, 2 Drawing Sheets**

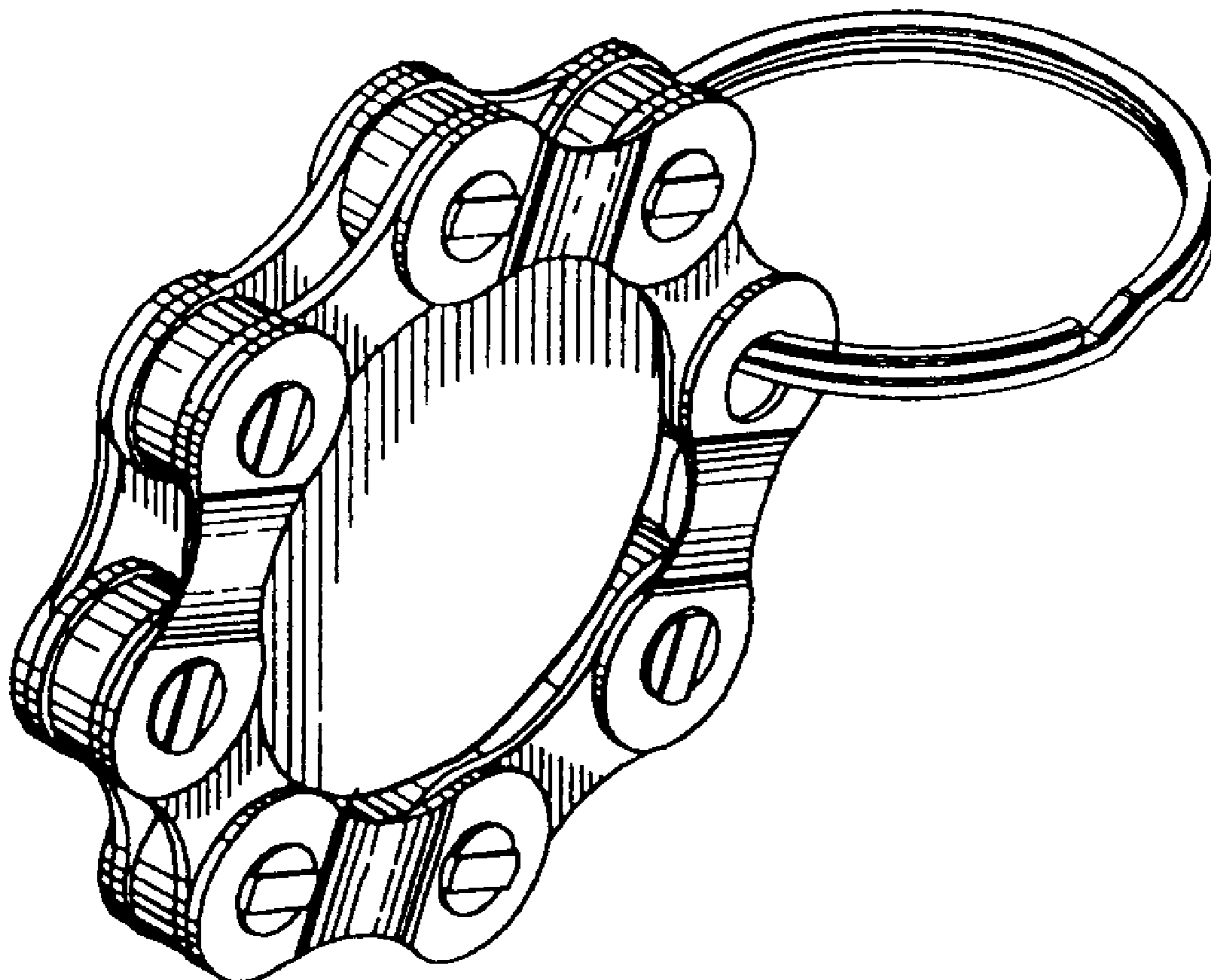

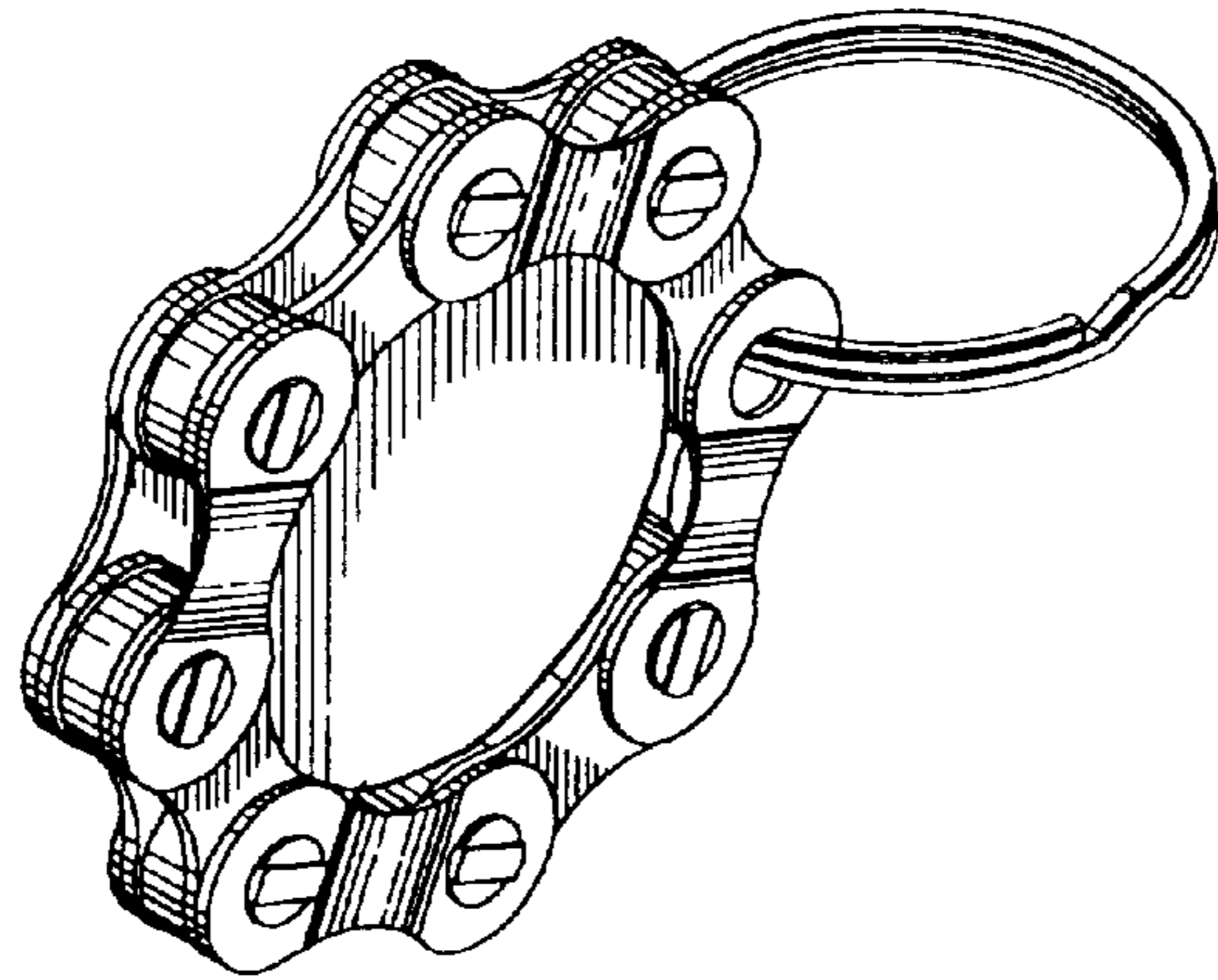

FIG. 1

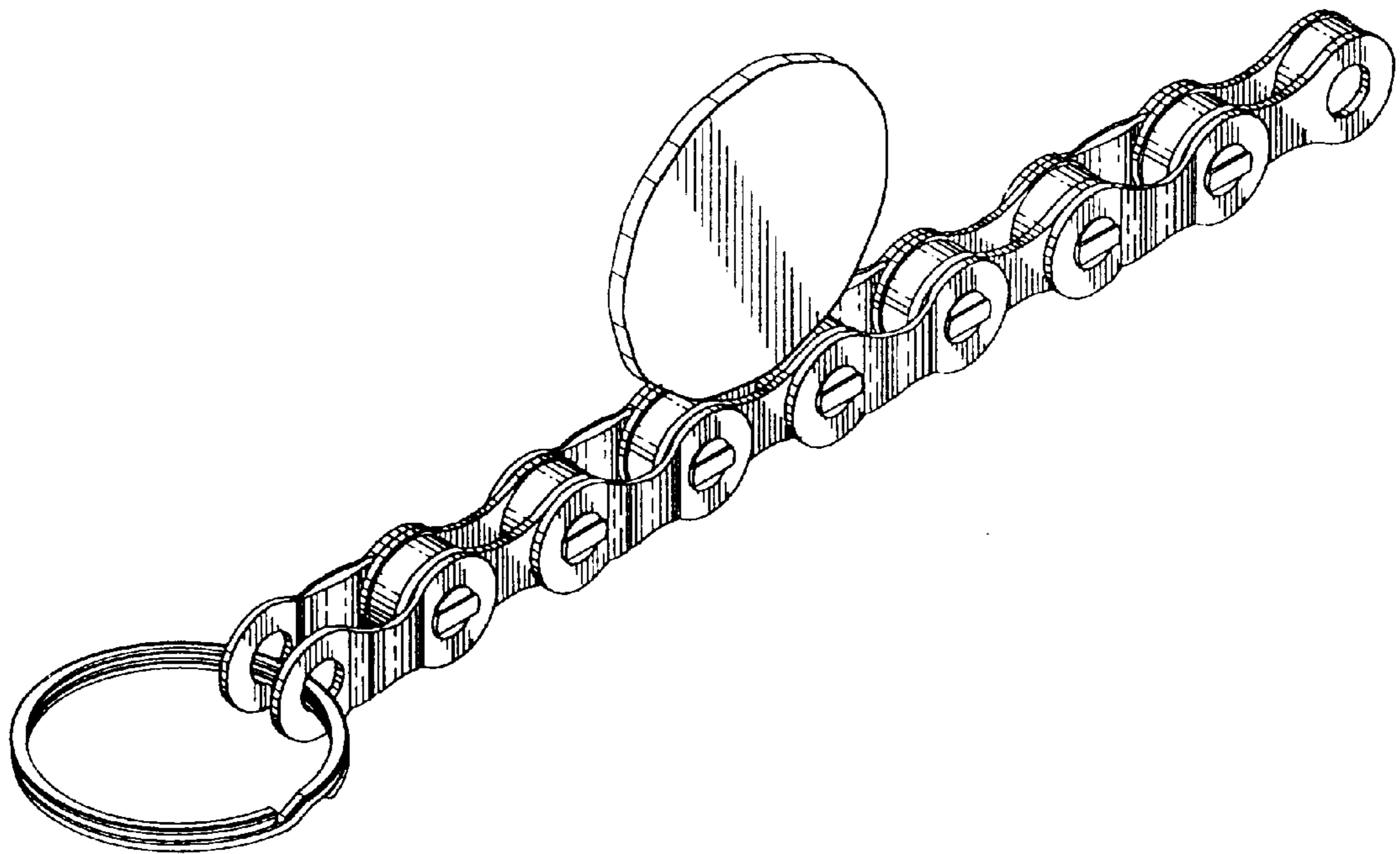

FIG. 8

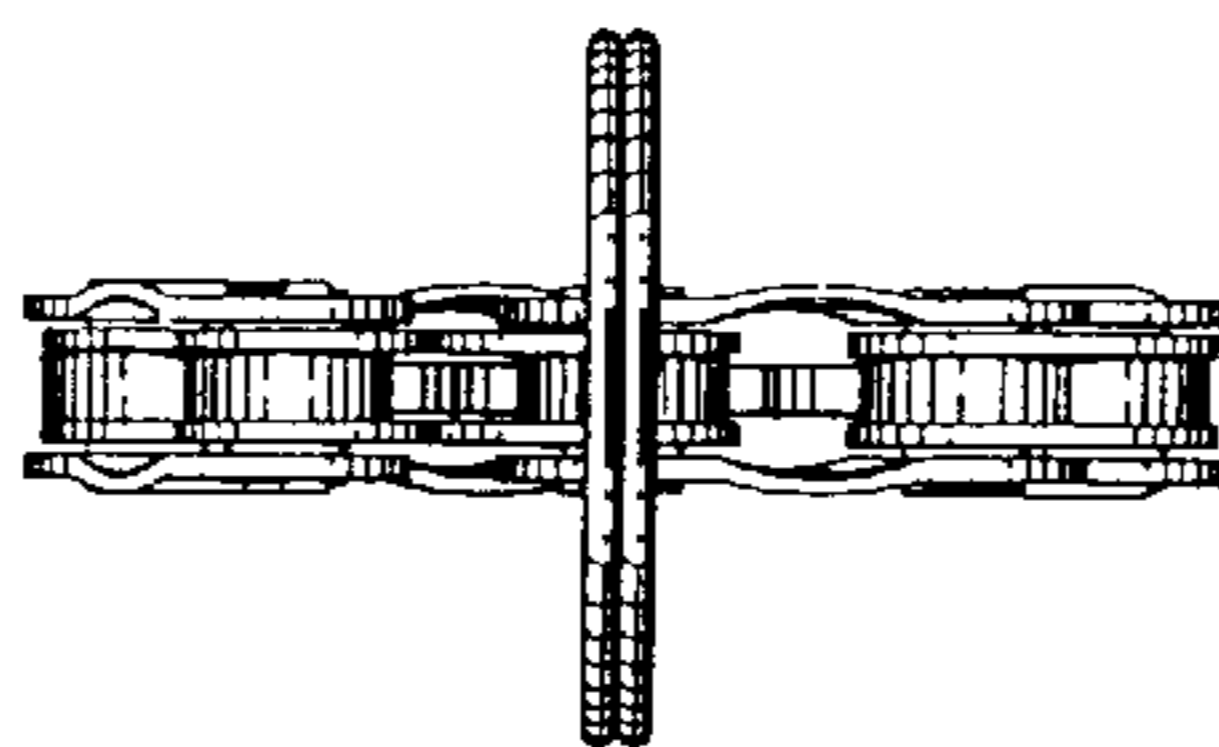

FIG. 2

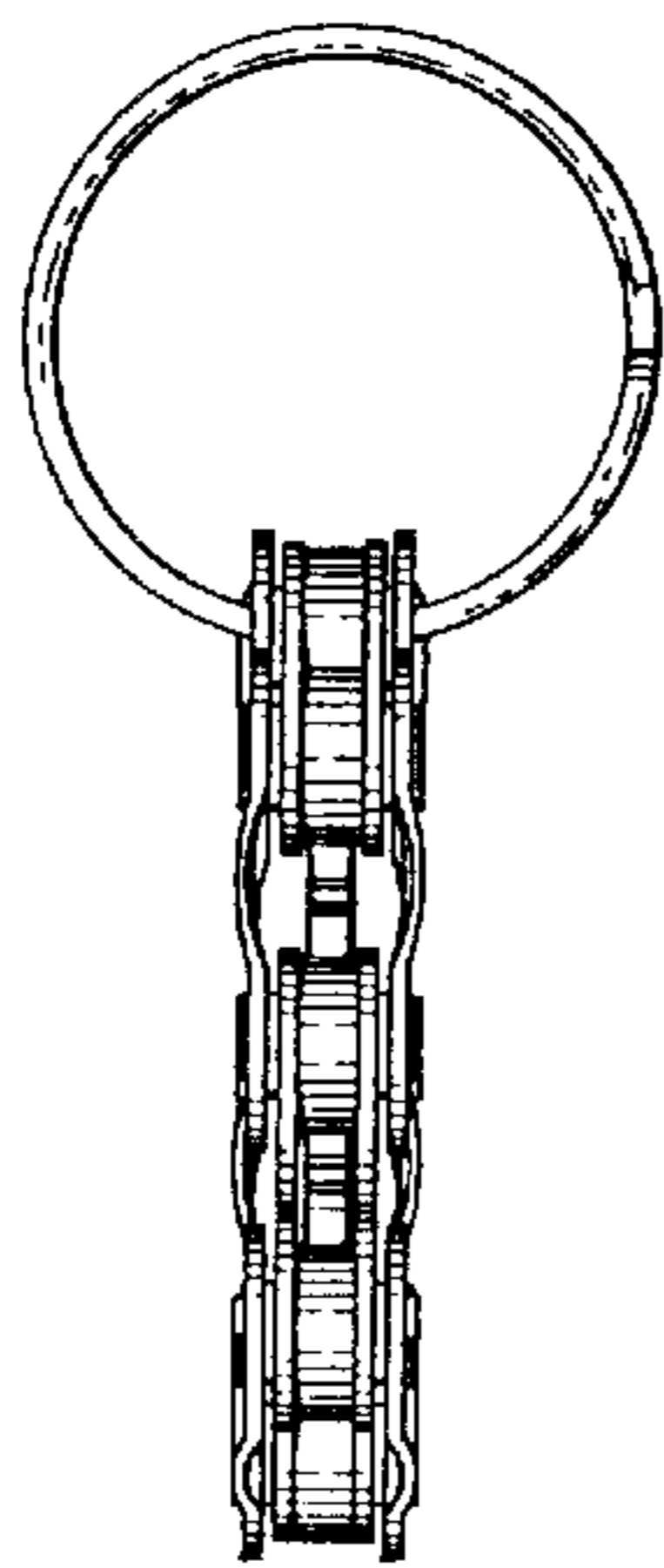

FIG. 3

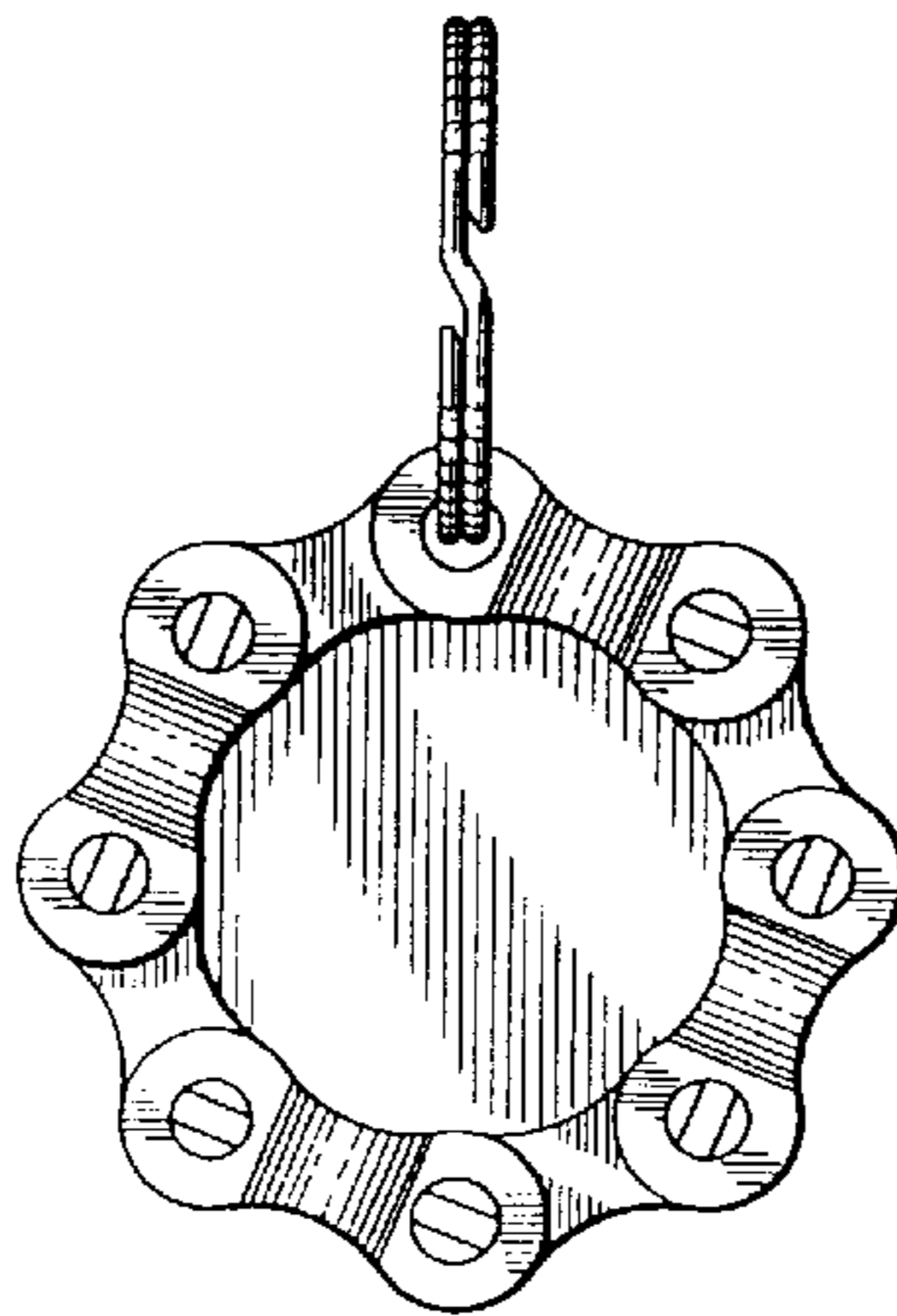

FIG. 4

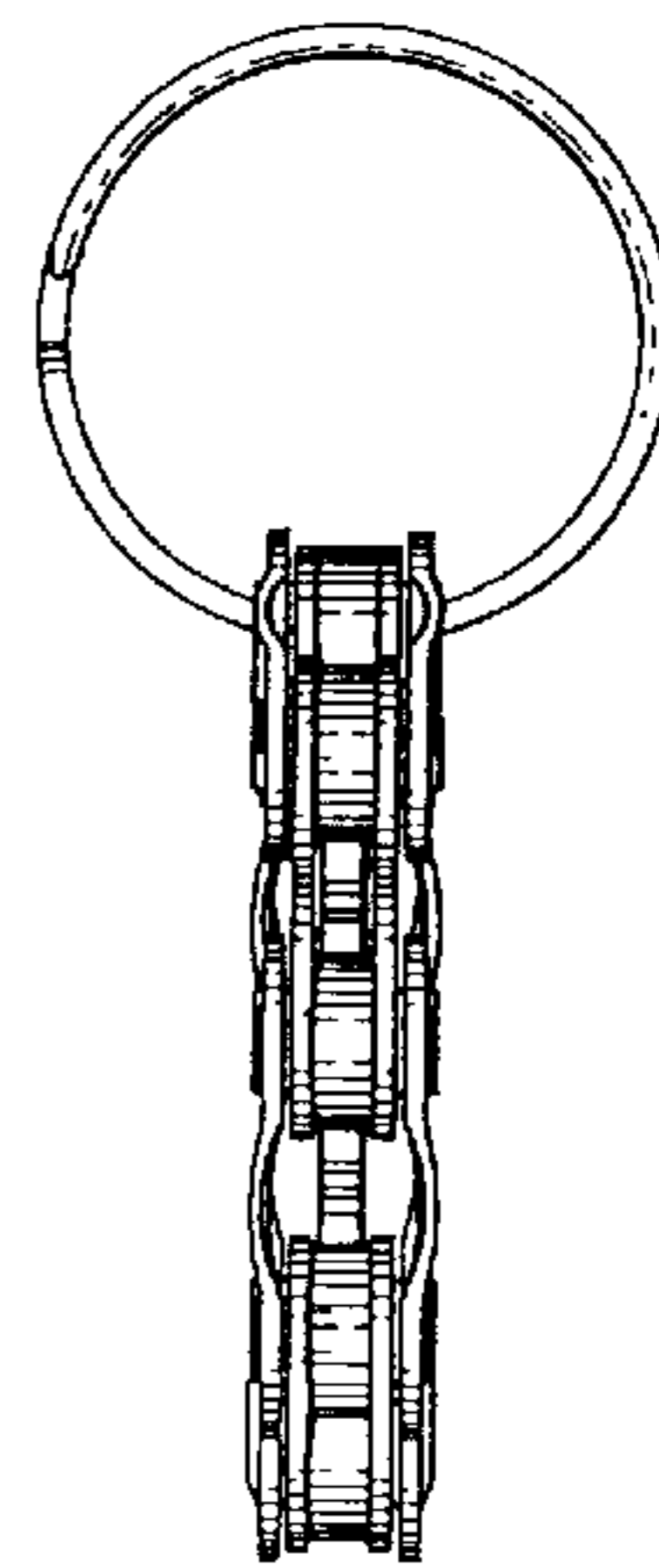

FIG. 5

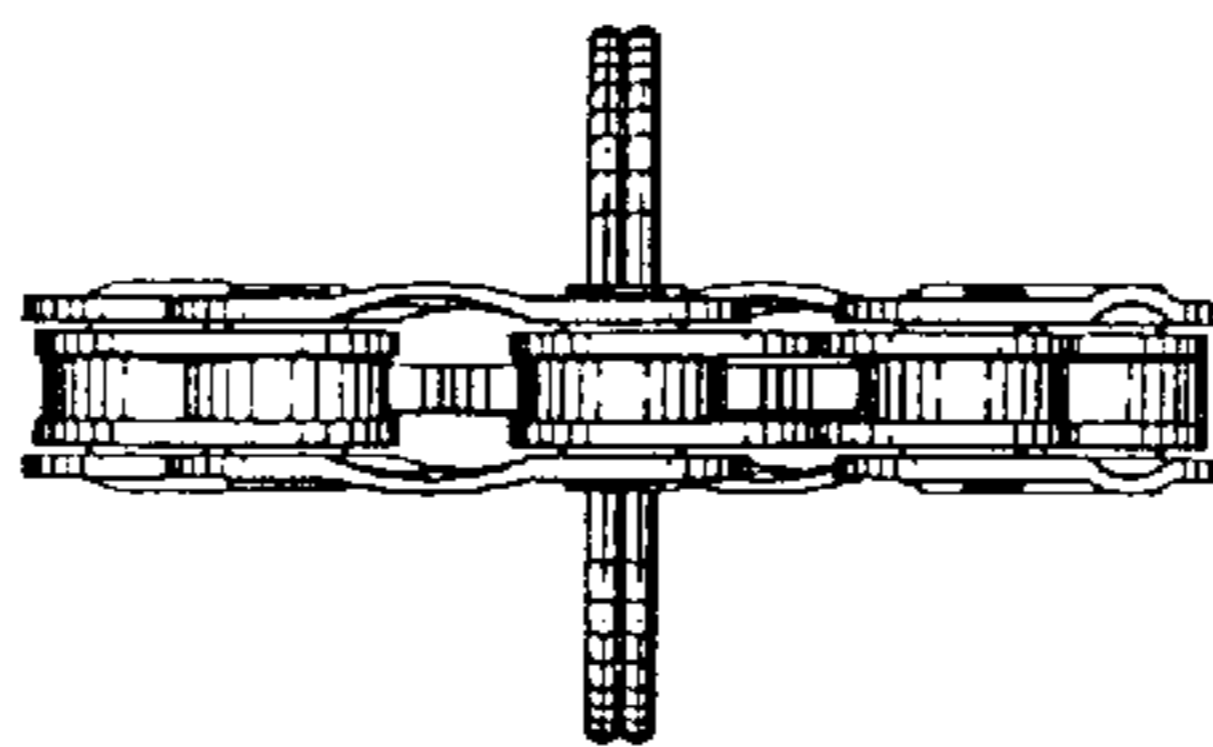

FIG. 6

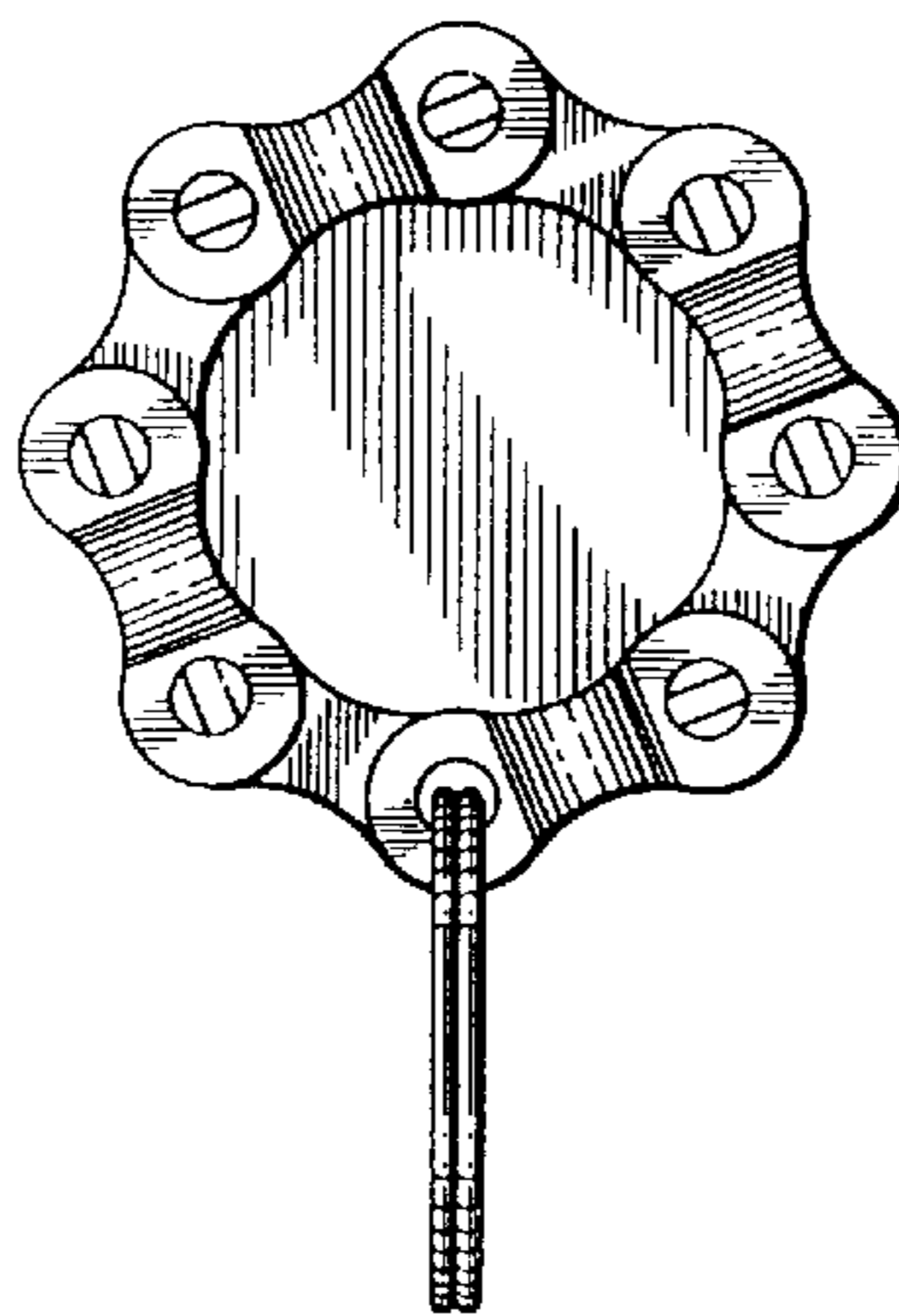

FIG. 7