



US00D411987S

United States Patent [19]

[11] Patent Number: **Des. 411,987**

Mizusugi et al.

[45] Date of Patent: **** Jul. 13, 1999**

[54] **COMBINED ELECTRONIC COMPUTER AND TELEPHONE**

[75] Inventors: **Kanji Mizusugi**, Mie-ken; **Takamitsu Morisaki**, Kyoto-fu; **Kensho Tsuji**, Nara-ken, all of Japan

[73] Assignee: **Sharp Kabushiki Kaisha**, Osaka, Japan

[**] Term: **14 Years**

[21] Appl. No.: **29/095,326**

[22] Filed: **Oct. 21, 1998**

Related U.S. Application Data

[30] **Foreign Application Priority Data**

Apr. 21, 1998 [JP] Japan 10-11665

[51] **LOC (6) Cl.** **14-02**

[52] **U.S. Cl.** **D14/101; D14/130**

[58] **Field of Search** D14/137, 138, D14/146, 148, 147, 149-151, 140-142, 240, 241, 129, 130, 101, 113; 379/433-436, 419, 420, 428, 440, 93.17, 916; 348/14, 17, 19

[56] References Cited

U.S. PATENT DOCUMENTS

- D. 259,421 6/1981 Janda D14/149
- D. 263,824 4/1982 Hagelbarger et al. D14/130
- D. 293,236 12/1987 Mastro et al. D14/151

- D. 293,441 12/1987 Kowalik et al. D14/151 X
- D. 295,408 4/1988 Boykiw D14/149
- D. 298,131 10/1988 Gagnon D14/149
- D. 303,965 10/1989 Helstab D14/142
- D. 307,008 4/1990 Shaanan et al. D14/151
- D. 317,757 6/1991 Yokoi et al. D14/101
- D. 323,657 2/1992 Danielson et al. D14/151
- D. 354,954 1/1995 Naito et al. D14/130
- 4,653,086 3/1987 Laube 379/916 X
- 5,369,700 11/1994 Koura et al. 379/93.17 X
- 5,577,118 11/1996 Sasaki et al. 379/428

Primary Examiner—Jeffrey Asch
Attorney, Agent, or Firm—Nixon & Vanderhye

[57] CLAIM

The ornamental design for a “combined electronic computer and telephone”, as shown and described.

DESCRIPTION

FIG. 1 is a top, front and right side perspective view of a combined electronic computer and telephone according to our design;
 FIG. 2 is a top plan view thereof;
 FIG. 3 is a front elevational view thereof;
 FIG. 4 is a rear elevational view thereof;
 FIG. 5 is a bottom plan view thereof;
 FIG. 6 is a left side elevational view thereof;
 FIG. 7 is a right side elevational view thereof; and,
 FIG. 8 is a view similar to FIG. 2, with the handset removed from the base.

1 Claim, 5 Drawing Sheets

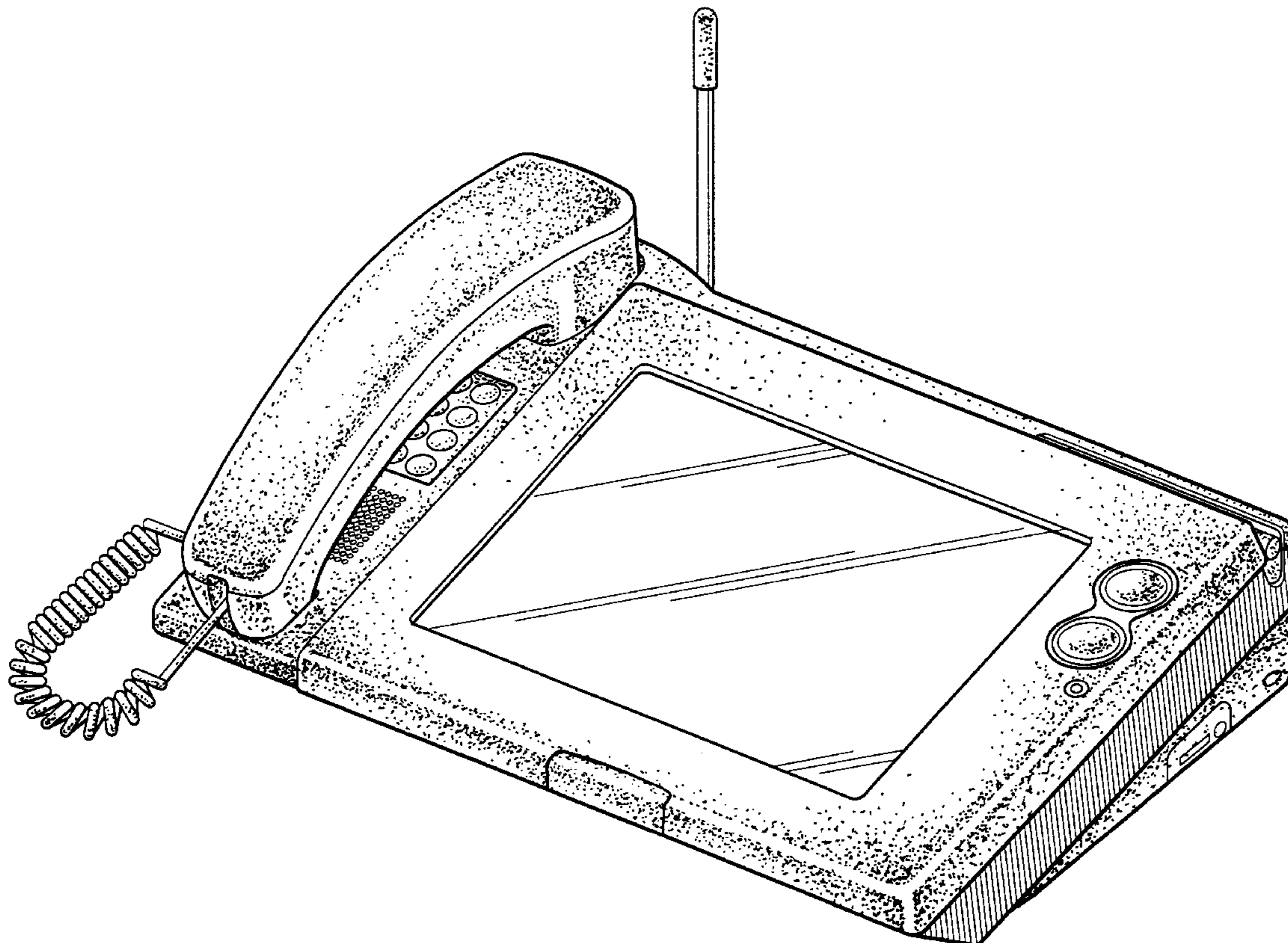

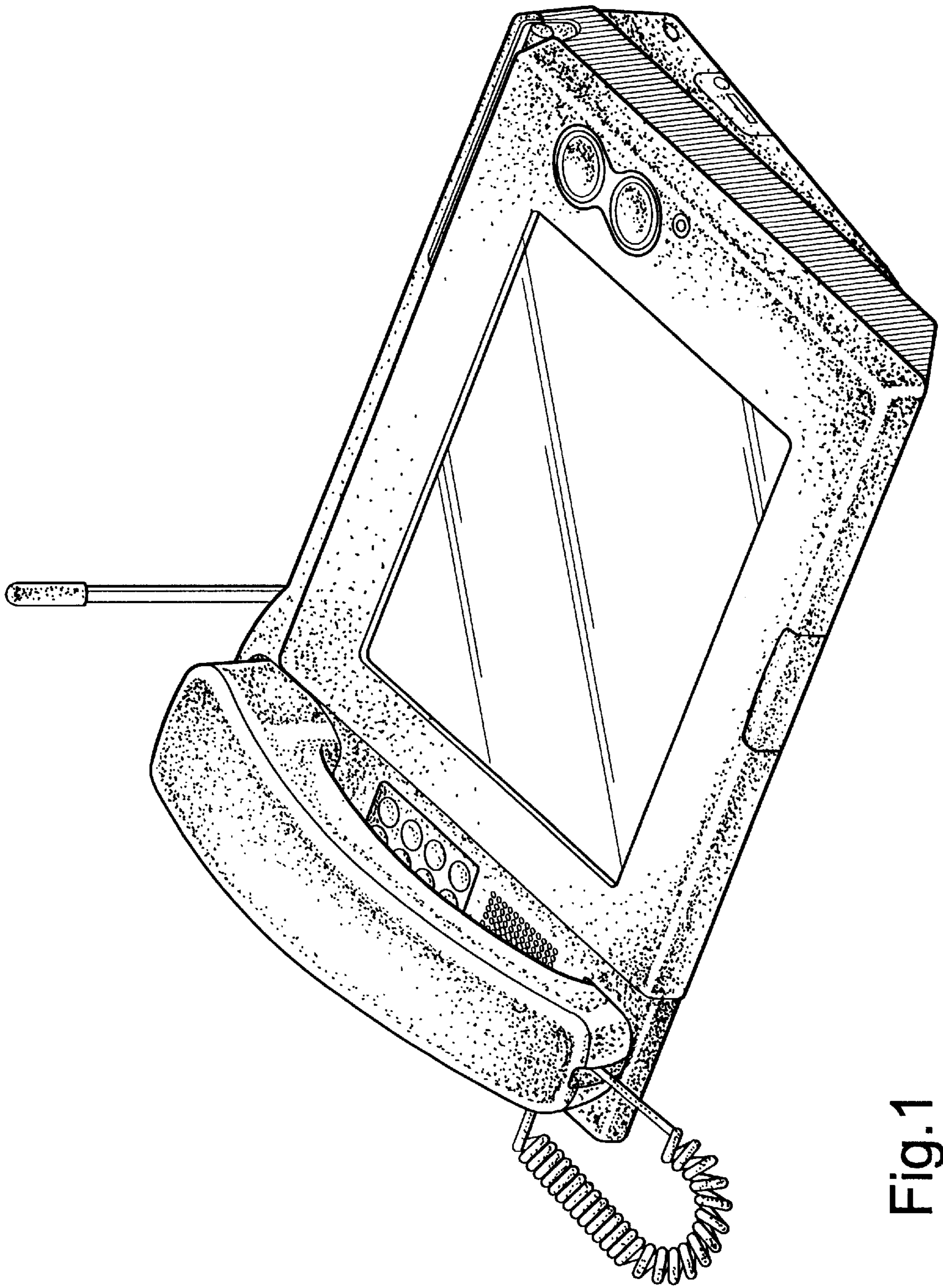
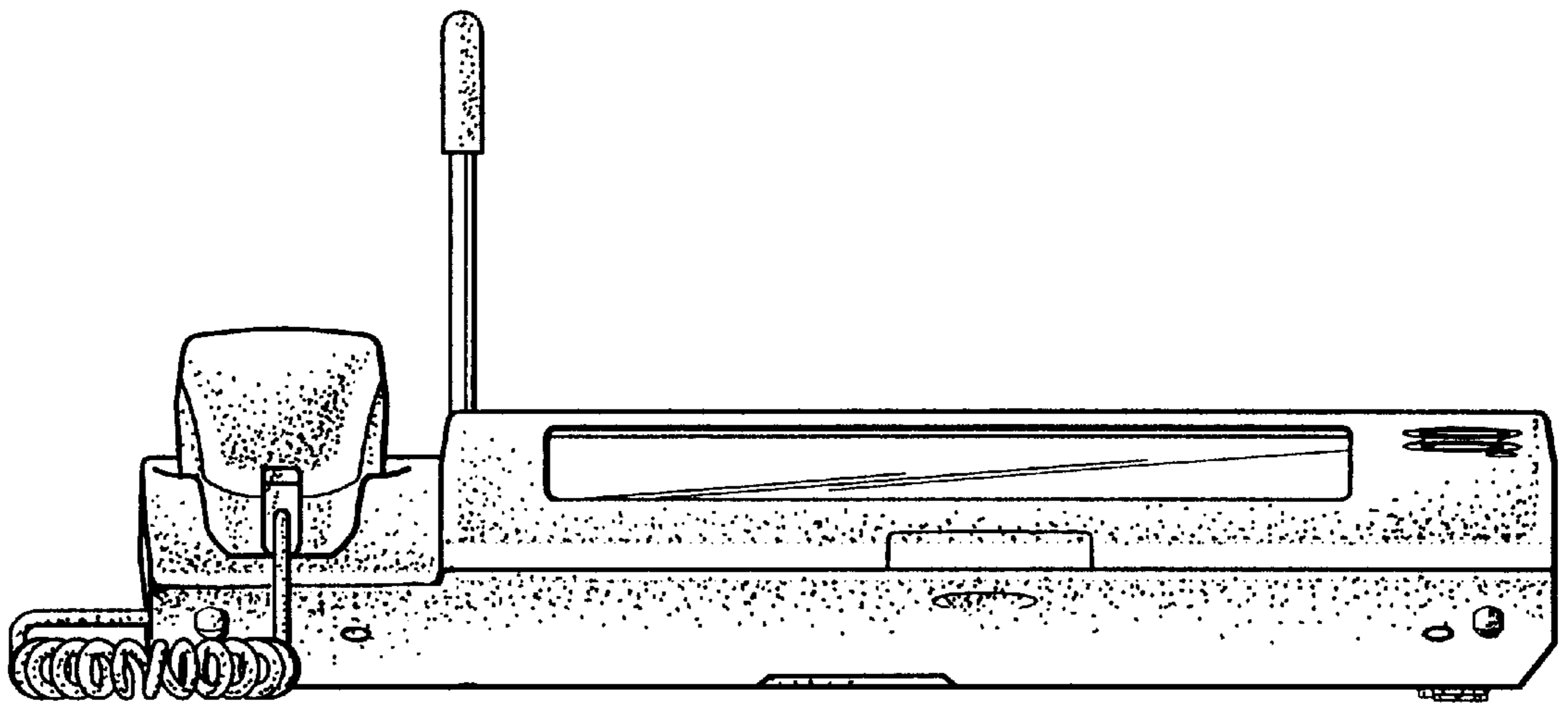
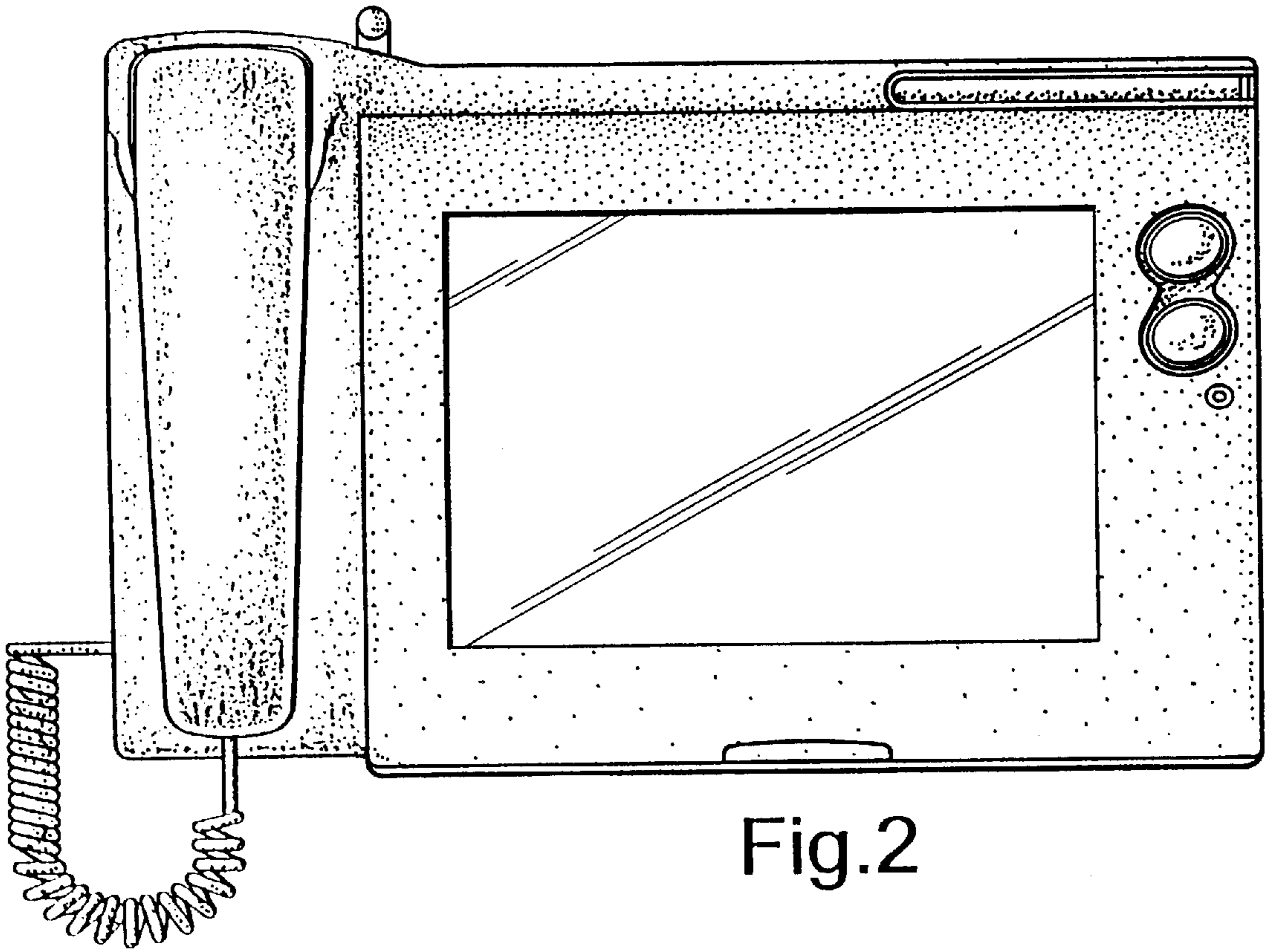

Fig. 1



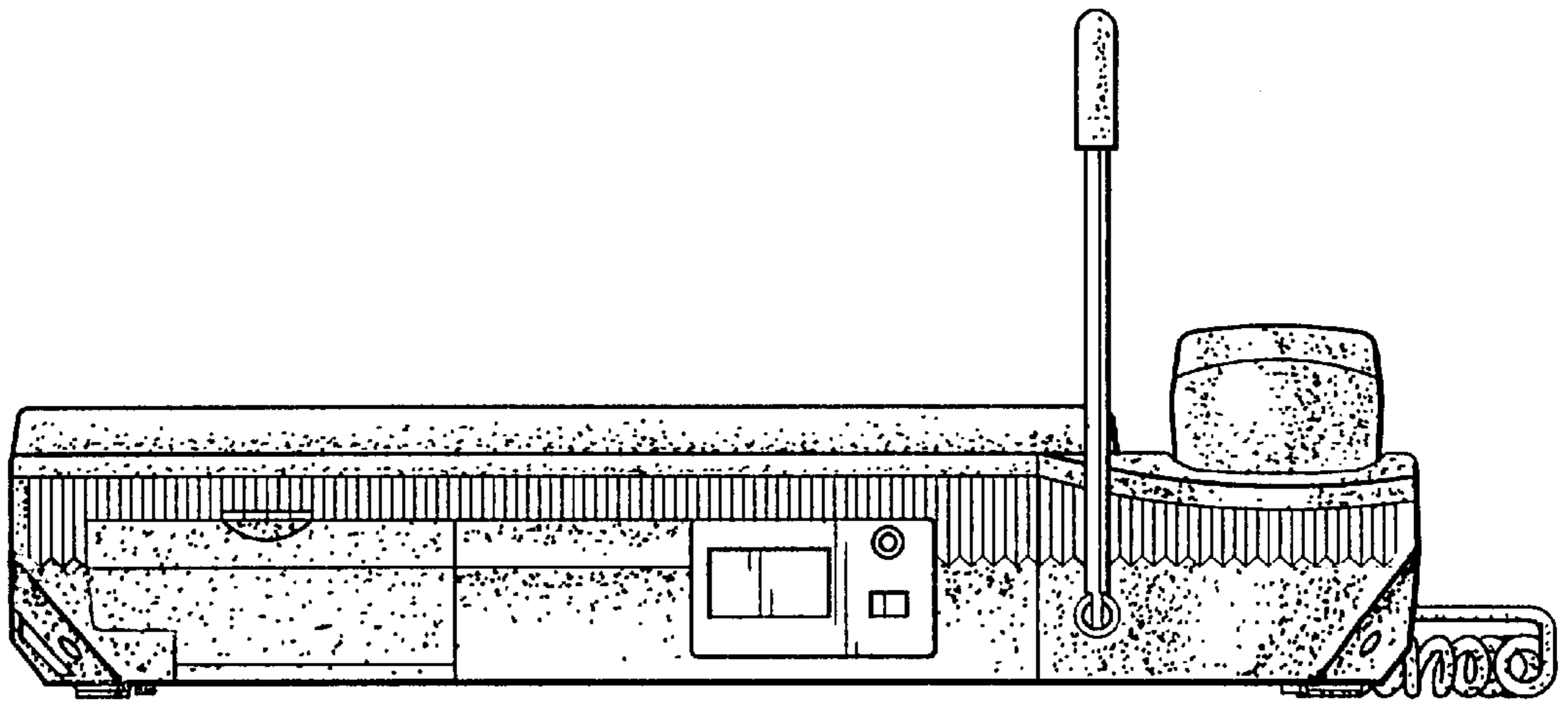

Fig.4

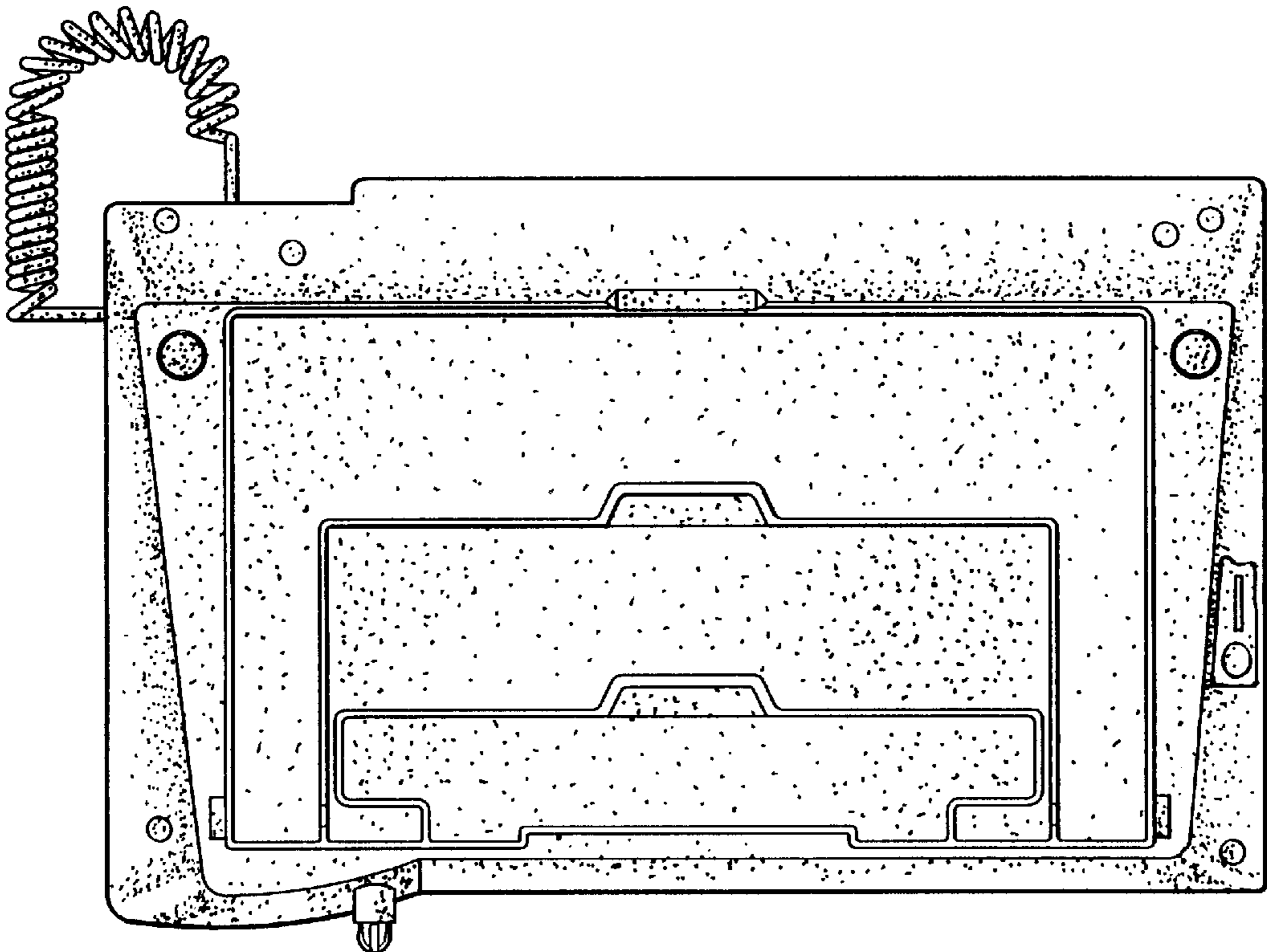

Fig.5

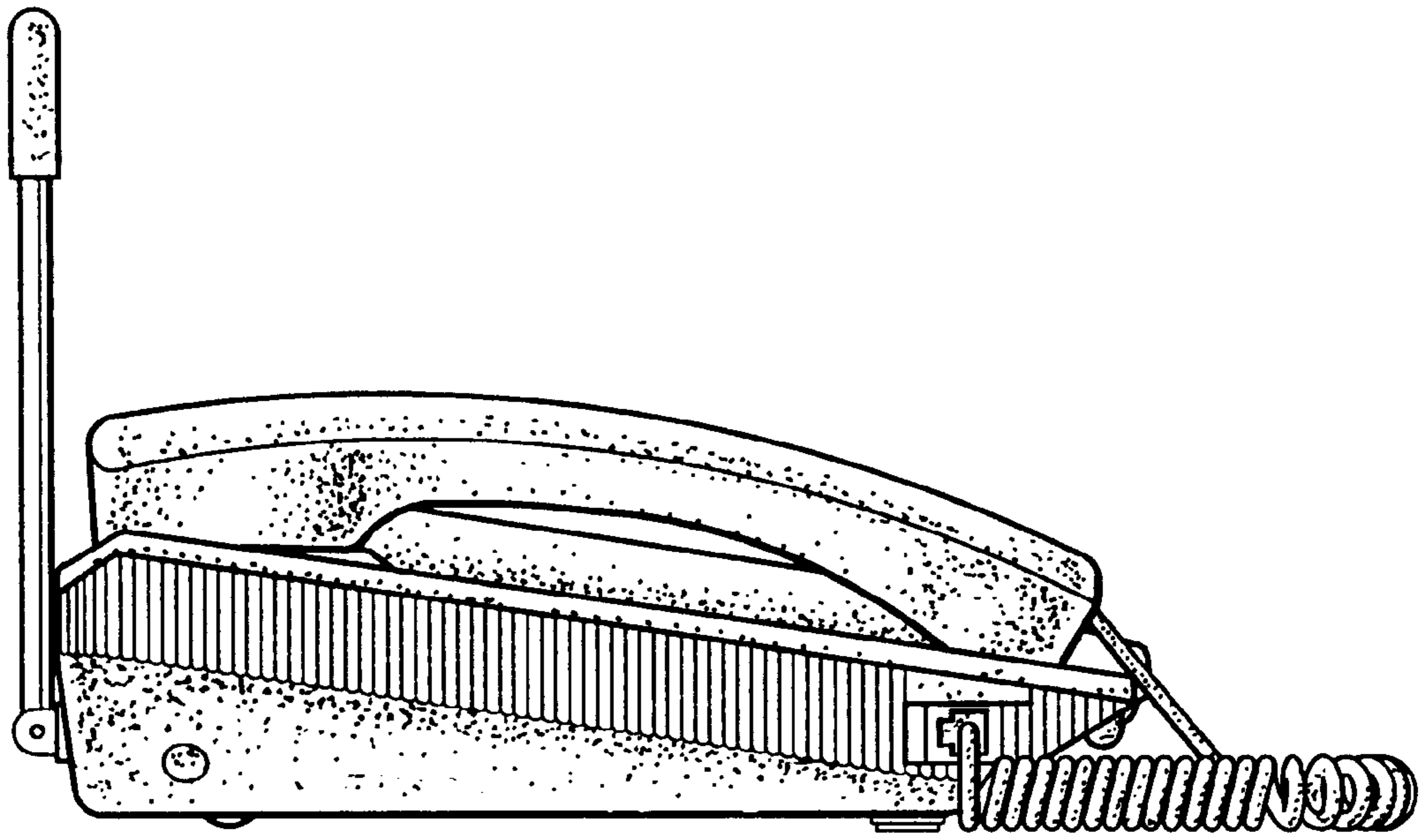

Fig.6

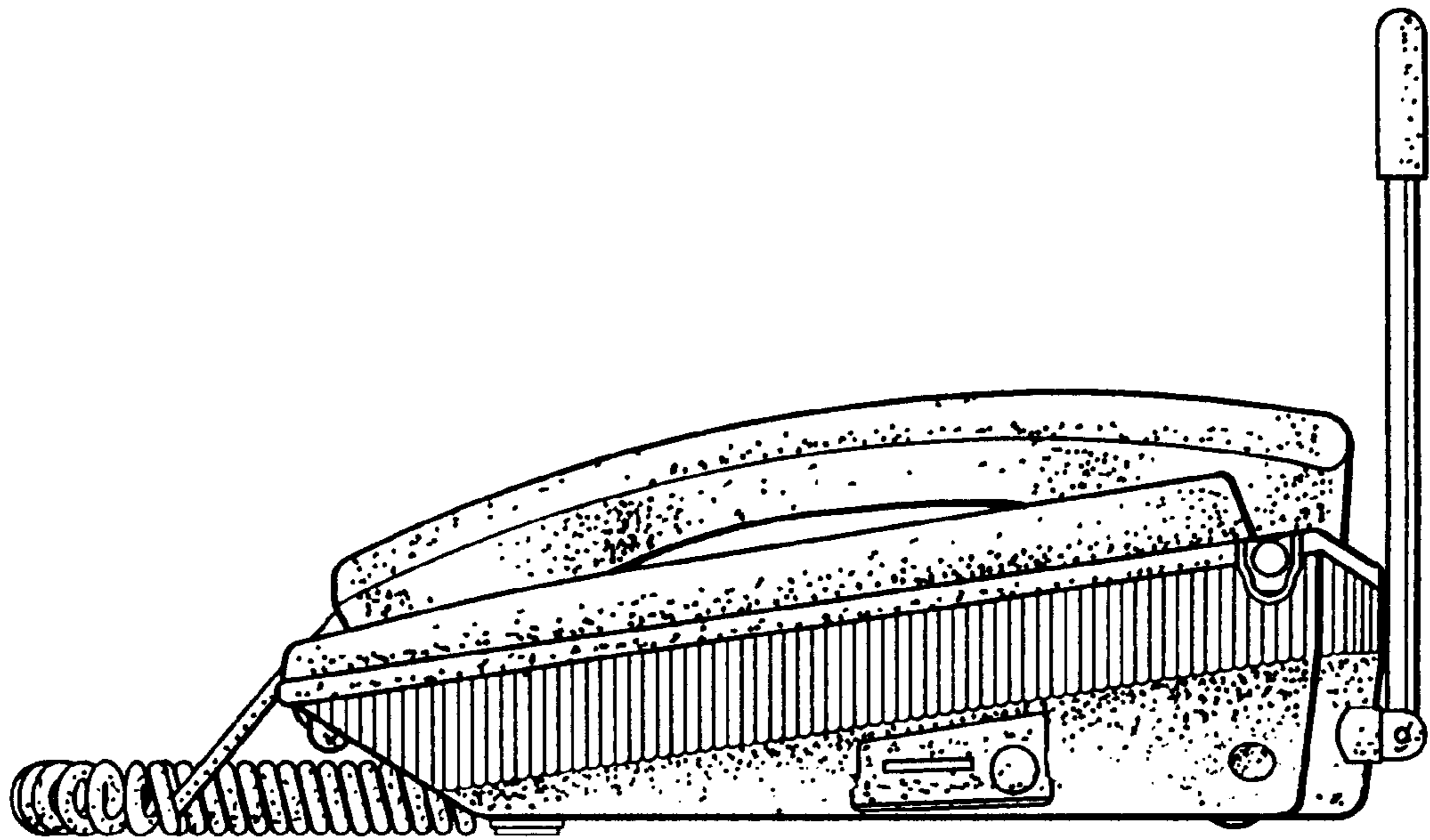

Fig.7

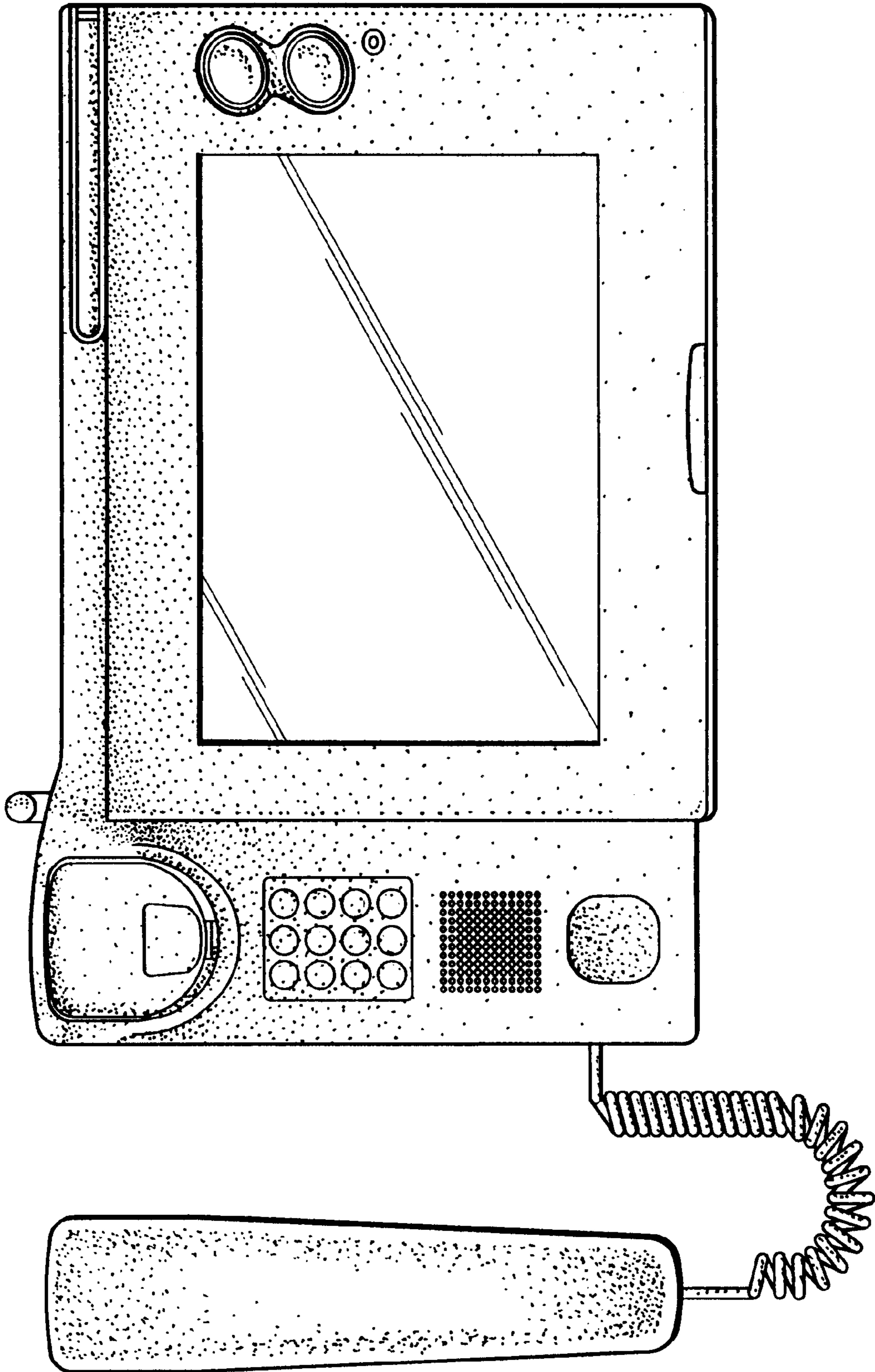

Fig. 8