



US00D411911S

# United States Patent [19] Carlson

[11] **Patent Number: Des. 411,911**  
[45] **Date of Patent: \*\* Jul. 13, 1999**

[54] **SHOE SOLE**  
[75] Inventor: **Ragnar Carlson, S. Yarmouth, Mass.**  
[73] Assignee: **The Rockport Company, Inc.,  
Marlborough, Mass.**  
[\*\*] Term: **14 Years**  
[21] Appl. No.: **29/096,345**  
[22] Filed: **Nov. 10, 1998**

### Related U.S. Application Data

[62] Division of application No. 29/087,402, May 1, 1998, Pat. No. Des. 405,948.  
[51] **LOC (6) Cl. .... 02-04**  
[52] **U.S. Cl. .... D2/957; D2/951; D2/953;  
D2/954; D2/956; D2/960**  
[58] **Field of Search .... D2/896, 897, 902,  
D2/906, 908, 909, 914, 916, 919, 946-962,  
964, 977; 36/3 B, 11.5, 12-15, 25 R, 28,  
32 R, 44, 59 C, 66, 75 R, 76 R, 85, 101,  
103, 104, 106, 113-115, 124, 126, 127-130**

### References Cited

#### U.S. PATENT DOCUMENTS

D. 294,077 2/1988 Kiyosawa et al. .... D2/956  
D. 294,655 3/1988 Heyes ..... D2/954  
D. 295,113 4/1988 Zuidema et al. .  
D. 295,231 4/1988 Heyes ..... D2/954  
D. 296,724 7/1988 Peterson .  
D. 299,983 2/1989 Zuidema et al. .... D2/960  
D. 303,996 10/1989 Feller ..... D2/955  
D. 305,278 1/1990 Kiyosawa ..... D2/954  
D. 317,826 7/1991 Austin ..... D2/957  
D. 319,725 9/1991 Calaveria ..... D2/955  
D. 323,580 2/1992 Hoshimi ..... D2/959  
D. 323,740 2/1992 Mitsui .  
D. 326,015 5/1992 Kayano .

D. 344,403 2/1994 O'Rorke .  
D. 356,669 3/1995 Kurosaki .  
D. 365,921 1/1996 von Conta et al. .  
D. 369,236 4/1996 Maltby ..... D2/959  
D. 377,411 1/1997 Murray ..... D2/953  
D. 377,859 2/1997 Bramani ..... D2/953  
D. 378,472 3/1997 Bramani ..... D2/957  
D. 387,545 12/1997 Cintron et al. .... D2/951  
D. 389,298 1/1998 Priant ..... D2/962  
D. 395,742 7/1998 Wurf Bain et al. .  
D. 398,144 9/1998 Egelja .  
D. 399,342 10/1998 Carlson .  
D. 399,343 10/1998 Egelja et al. .  
D. 399,645 10/1998 Percuoco .  
D. 400,696 11/1998 Covatch ..... D2/954  
D. 402,095 12/1998 Cretinon ..... D2/957  
D. 404,899 2/1999 VonConta ..... D2/957  
D. 404,902 2/1999 Pawlus ..... D2/959  
D. 405,597 2/1999 Carlson ..... D2/960  
1,194,152 8/1916 Douglas ..... 36/28  
5,216,824 6/1993 Blissett et al. .... 36/28

*Primary Examiner*—Celia Murphy  
*Attorney, Agent, or Firm*—Sterne, Kessler, Goldstein & Fox PLLC

### [57] CLAIM

The ornamental design for a shoe sole, as shown and described.

### DESCRIPTION

FIG. 1 is a bottom plan view of a shoe sole showing an alternate embodiment of my new design;  
FIG. 2 is a left side elevational view thereof;  
FIG. 3 is a right side elevational view thereof;  
FIG. 4 is a front elevational view thereof;  
FIG. 5 is a rear elevational view thereof;  
FIG. 6 is a right side perspective view thereof; and,  
FIG. 7 is a left side perspective view thereof.  
The broken line showing of a shoe midsole in the figures is environmental only and forms no part of the claimed design.

1 Claim, 2 Drawing Sheets

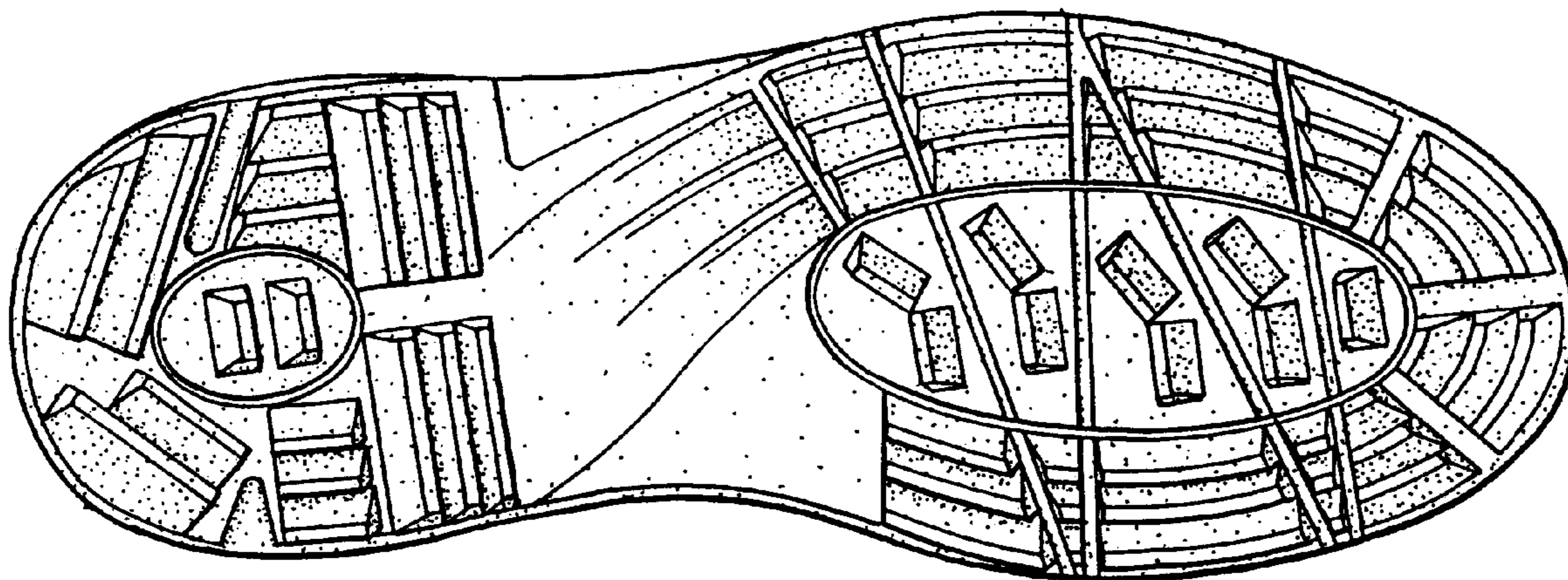

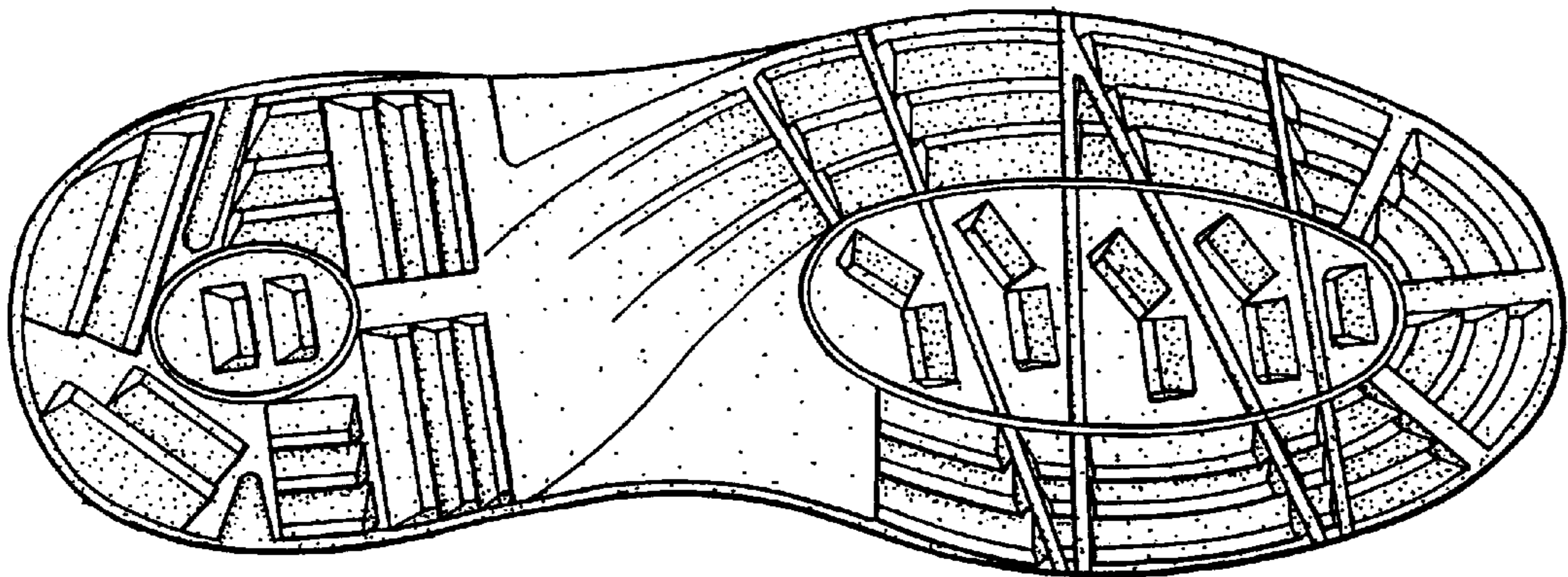

FIG. 1

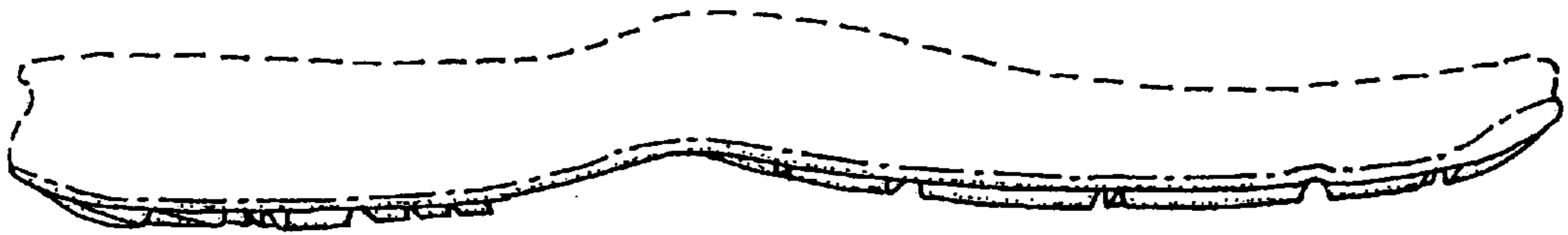

FIG. 2

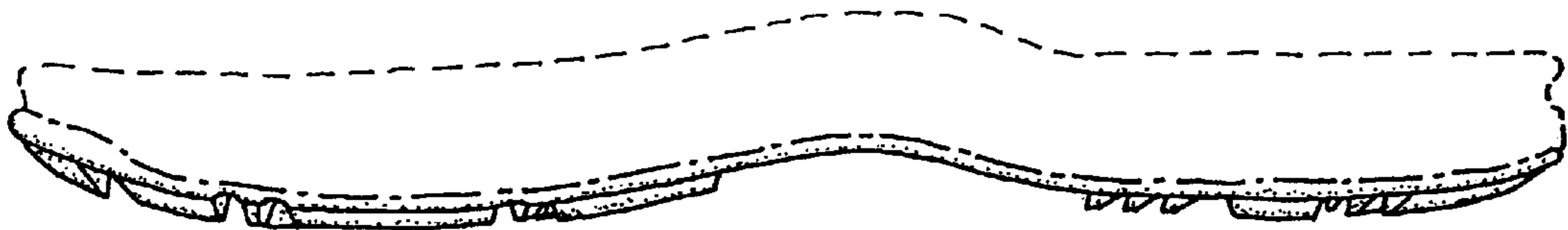

FIG. 3



FIG. 4

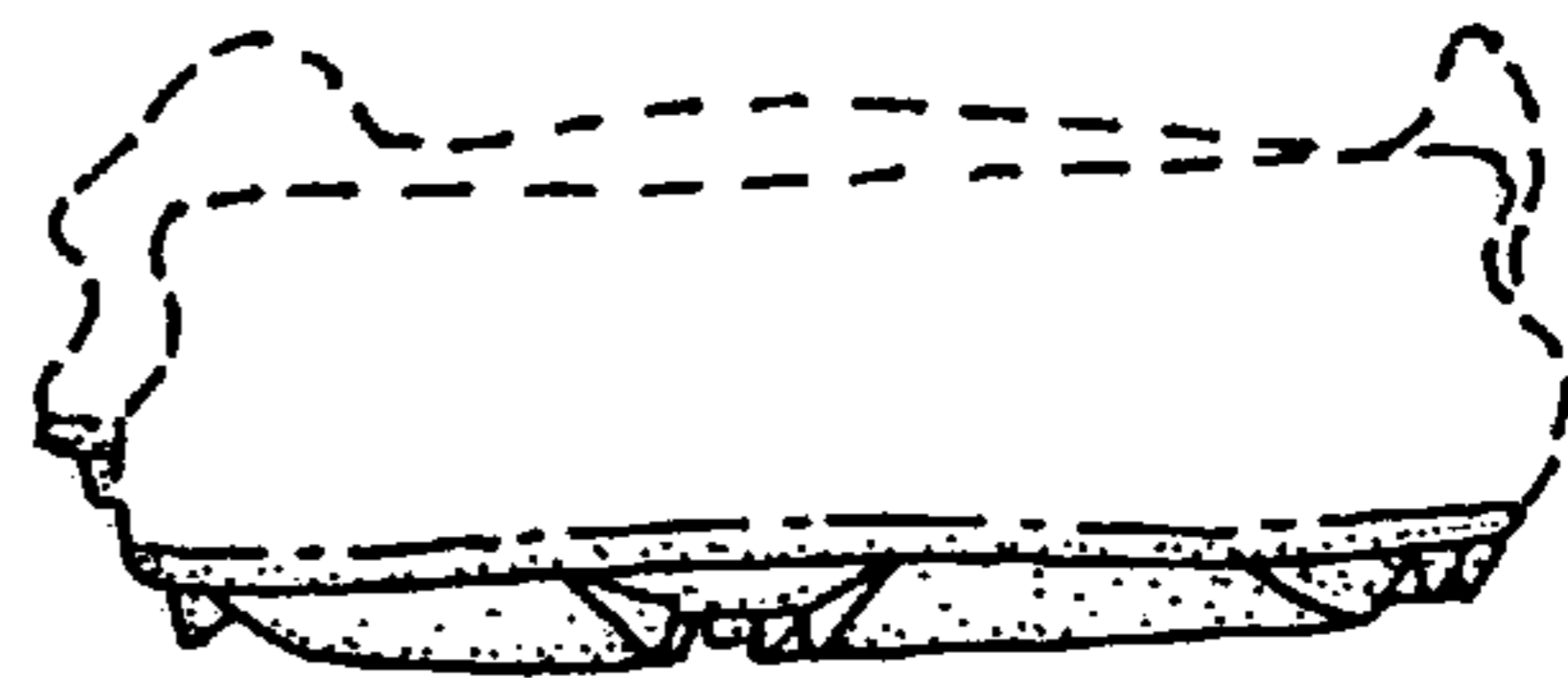

FIG. 5

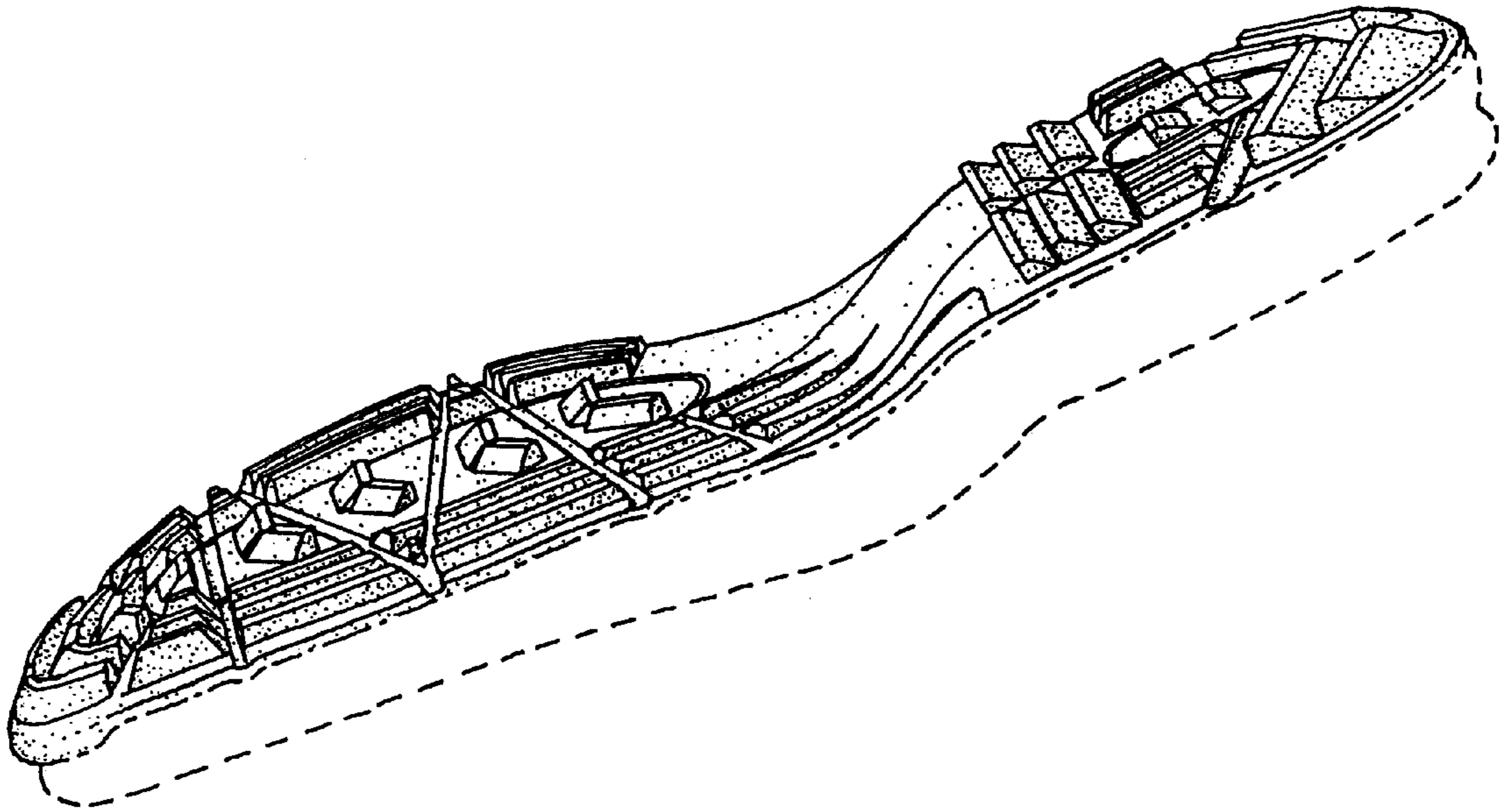

FIG. 6

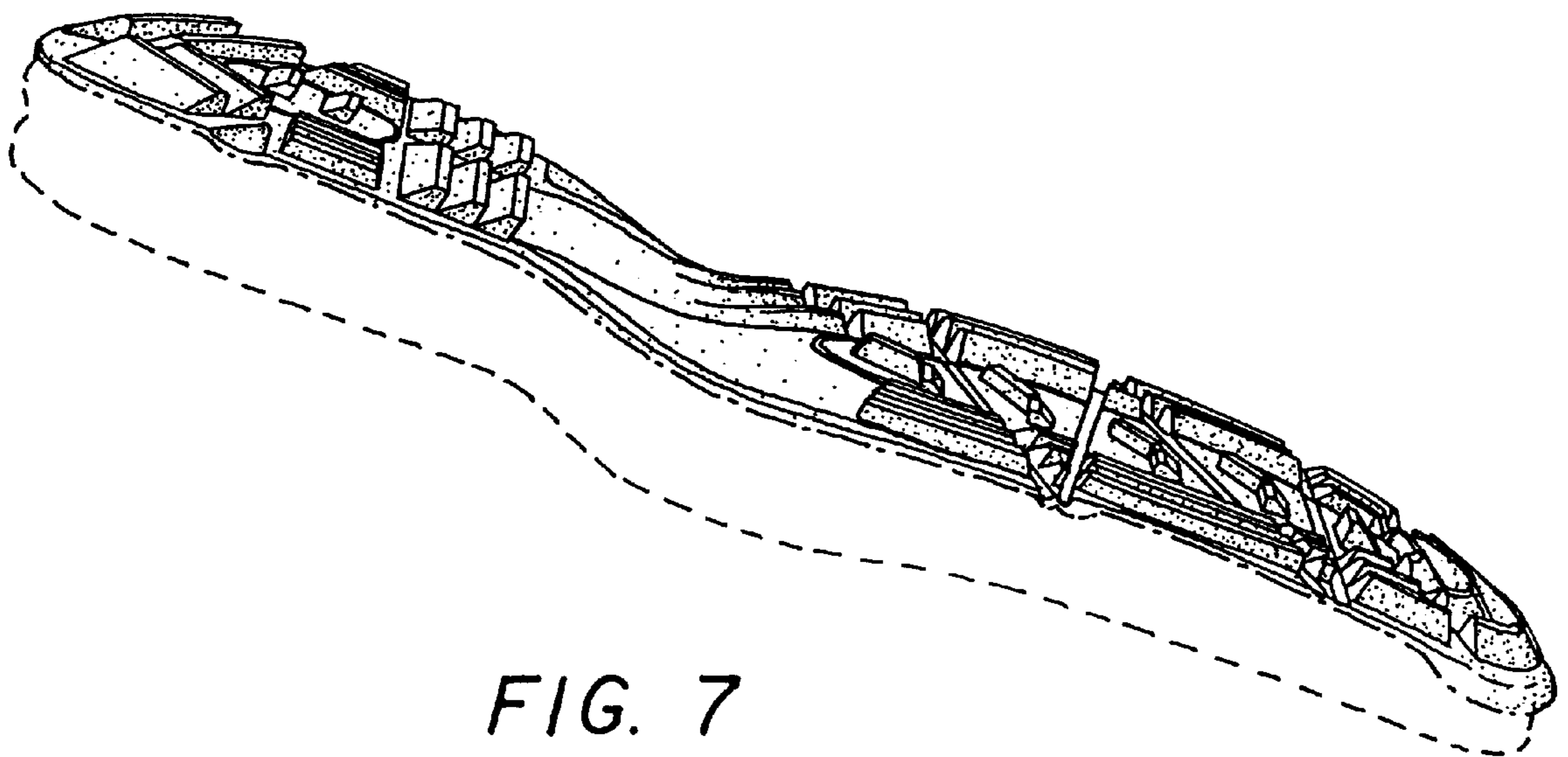

FIG. 7