



US00D411878S

United States Patent [19]
Svendsen

[11] **Patent Number: Des. 411,878**

[45] **Date of Patent: ** Jul. 6, 1999**

[54] **TUB LEG**

D. 24,777 10/1895 Marschuetz D23/280.4
D. 76,216 9/1928 Bauer .

[75] Inventor: **Sean W. Svendsen**, Columbus, Ohio

[73] Assignee: **American Standard Inc.**, Piscataway, N.J.

[**] Term: **14 Years**

Primary Examiner—Louis S. Zarfaz
Assistant Examiner—Eric Watterson

[21] Appl. No.: **29/086,559**

[22] Filed: **Apr. 15, 1998**

[51] **LOC (6) Cl.** **23-02**

[52] **U.S. Cl.** **D23/303; D6/497**

[58] **Field of Search** D23/303-311,
D23/276-280.4; D6/495, 497; 4/538, 594,
595, 661

[57] **CLAIM**

The ornamental design for a tub leg, as shown and described.

DESCRIPTION

FIG. 1 is a top, front, and left side perspective view of a tub leg showing my new design;
FIG. 2 is a top plan view thereof;
FIG. 3 is a front elevational view thereof;
FIG. 4 is a right side elevational view thereof;
FIG. 5 is a rear elevational view thereof; and,
FIG. 6 is a bottom plan view thereof.

[56] **References Cited**

U.S. PATENT DOCUMENTS

D. 23,351 6/1894 Peet D23/303

1 Claim, 3 Drawing Sheets

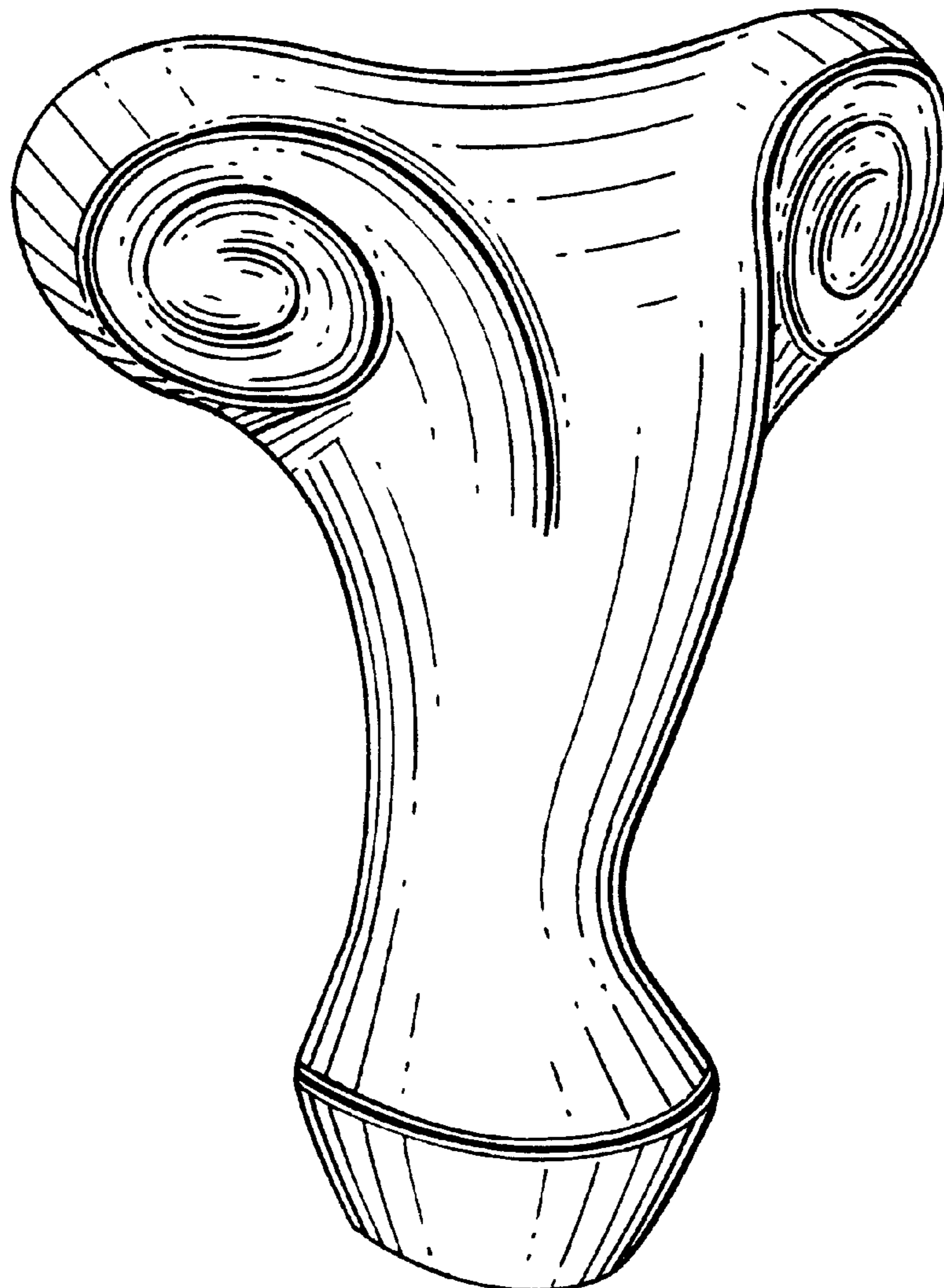

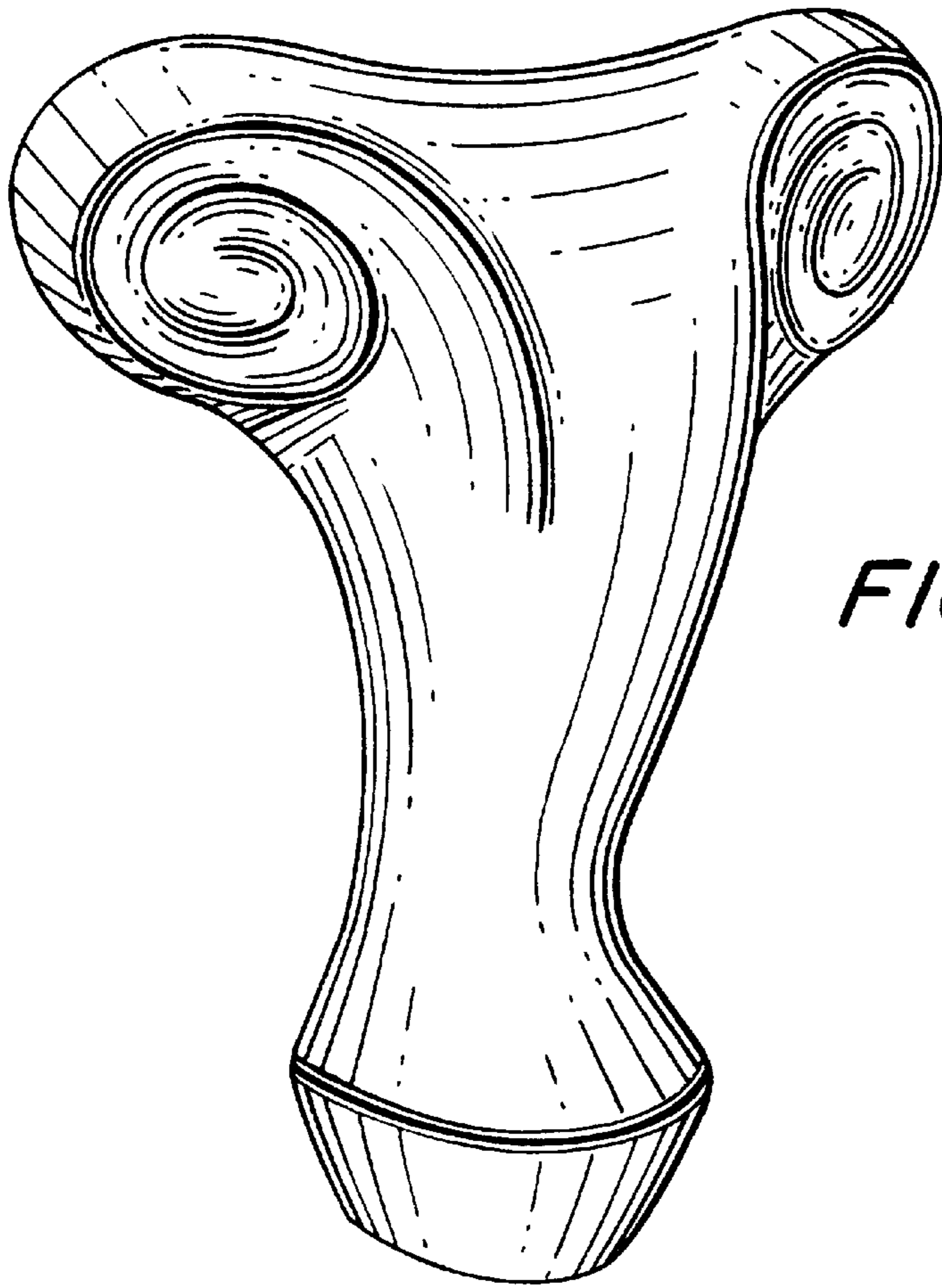
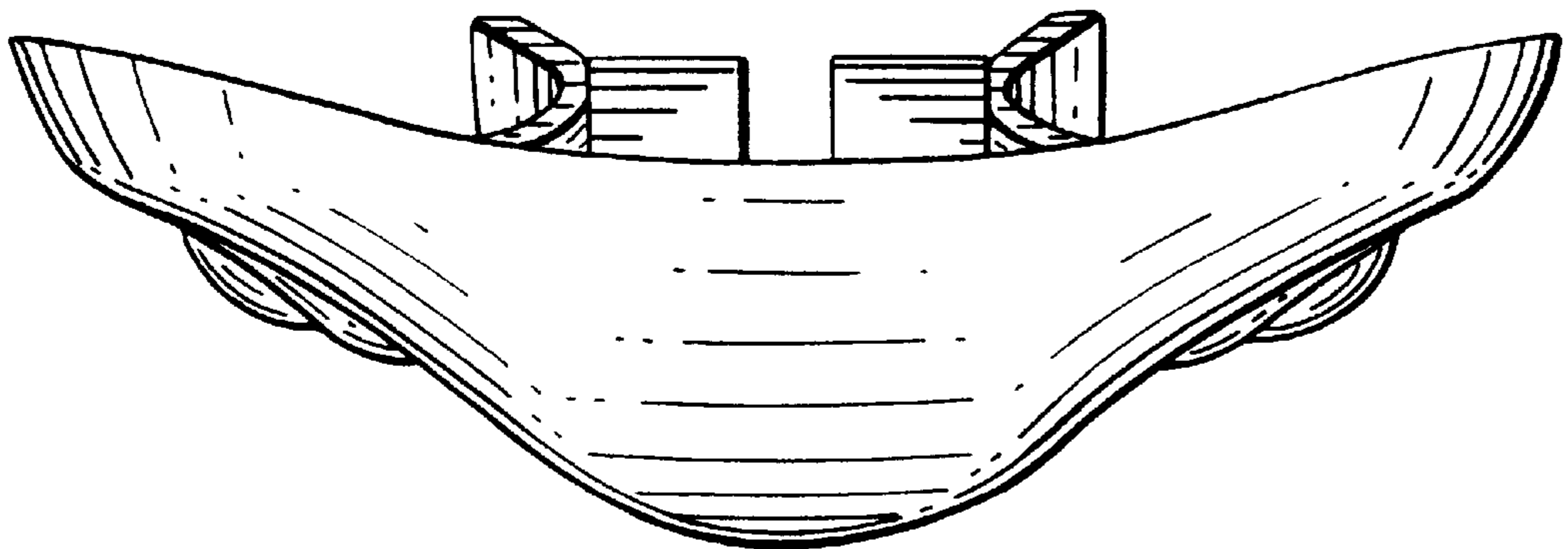

FIG. 1

FIG. 2



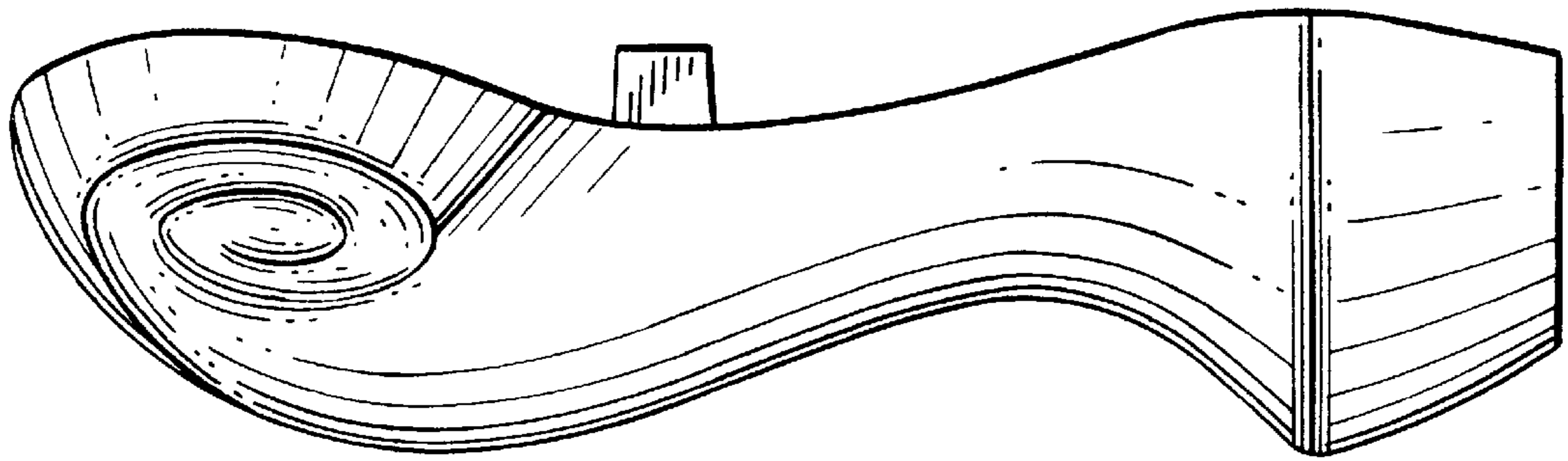

FIG. 4

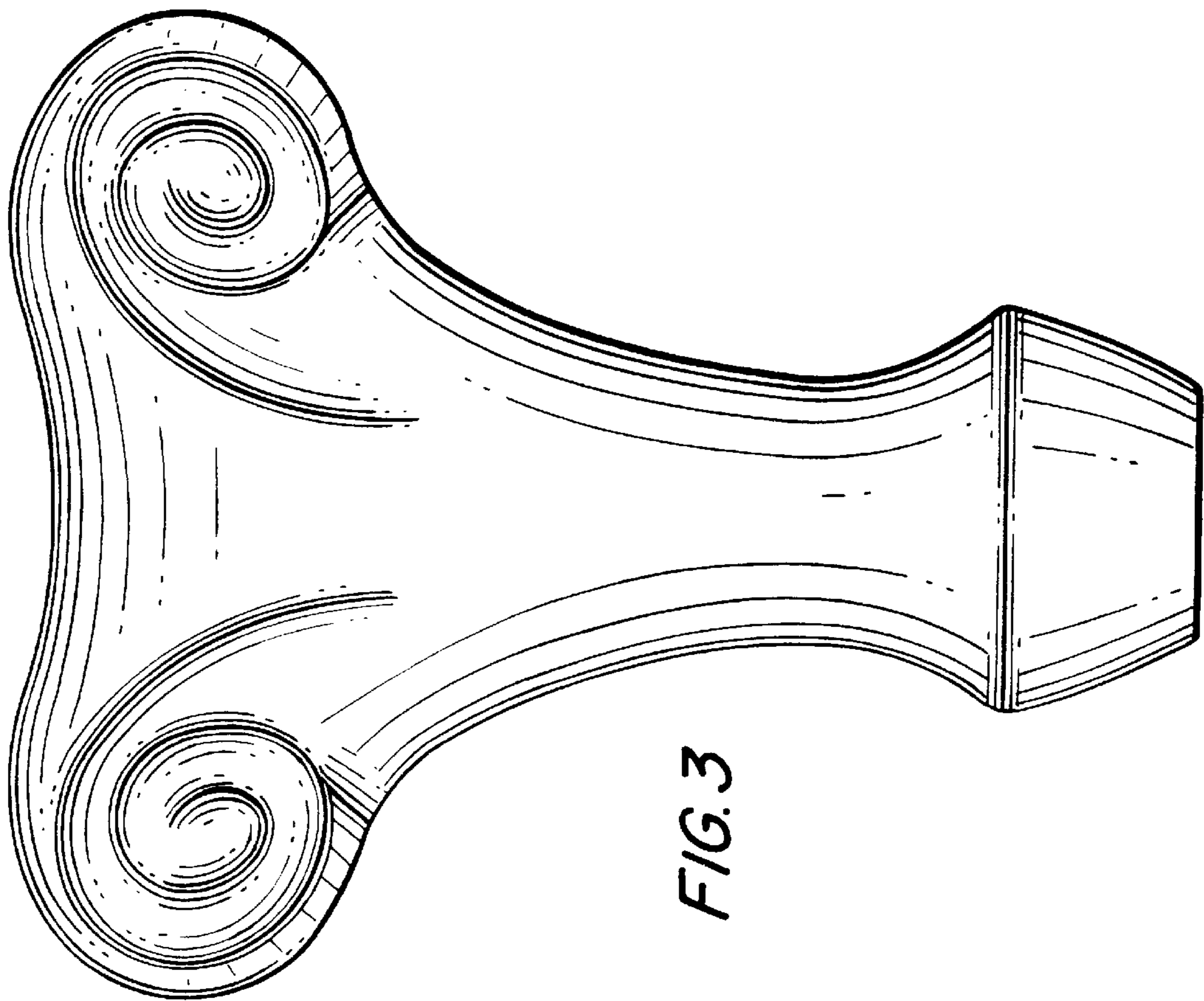

FIG. 3

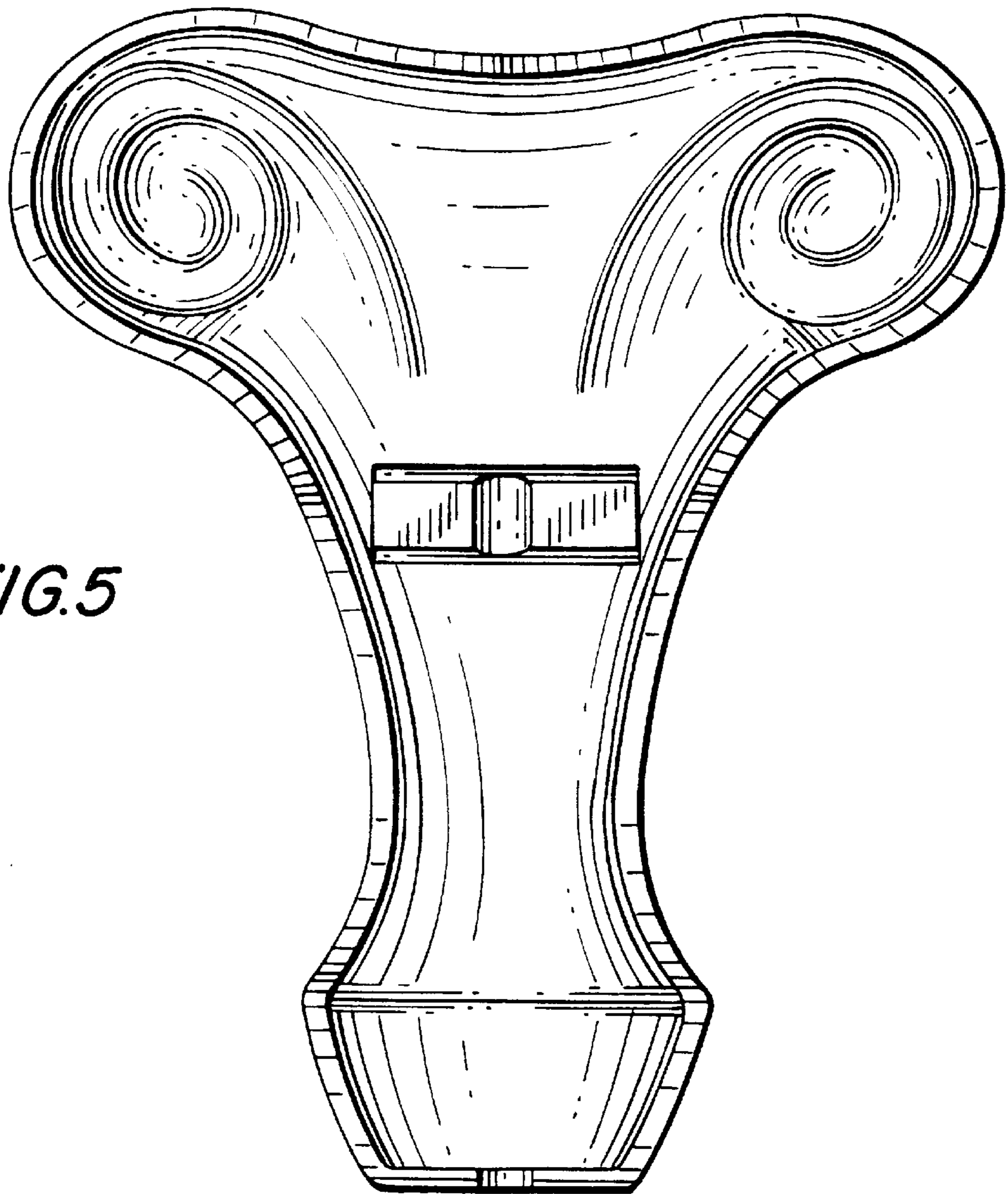

FIG. 5

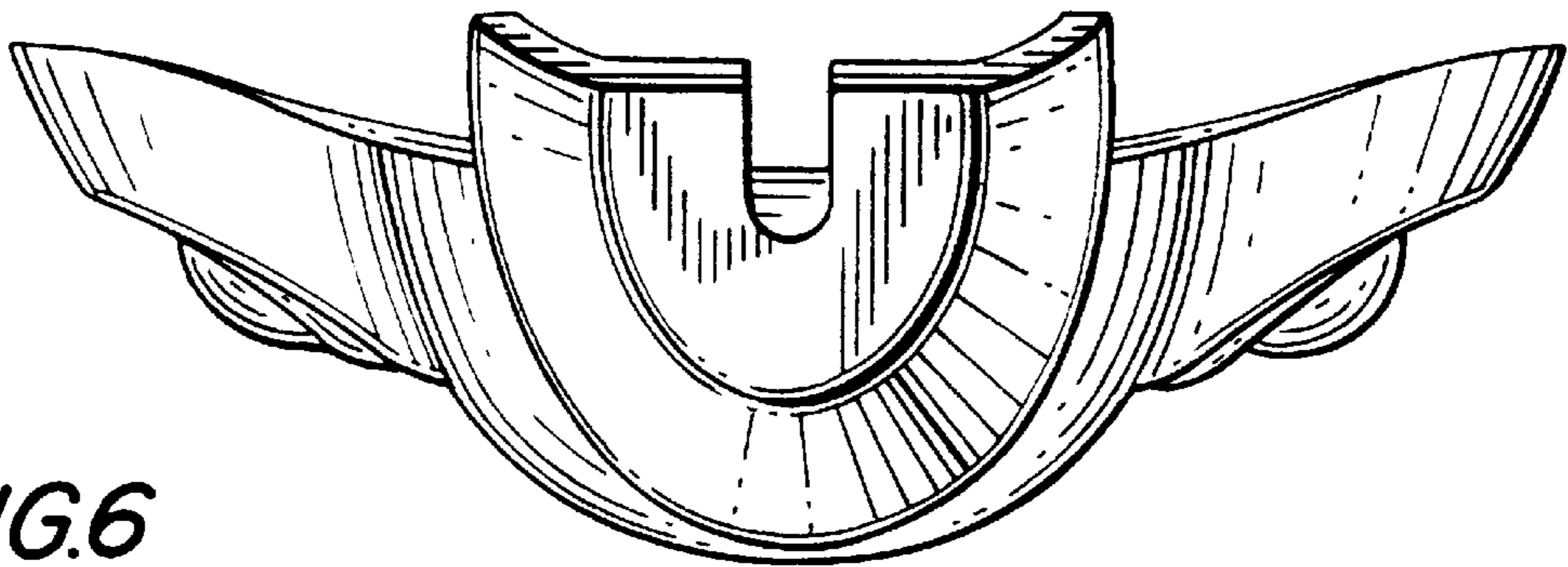

FIG. 6