



US00D411846S

United States Patent [19] Jo

[11] **Patent Number: Des. 411,846**
[45] **Date of Patent: ** Jul. 6, 1999**

[54] **SPEAKER FOR COMPUTER**
[75] Inventor: **Cheong Dong Jo**, Chunchon-shi, Rep. of Korea
[73] Assignee: **Eastern Acoustic Co., Ltd.**, Kyungki-do, Rep. of Korea
[**] Term: **14 Years**

D. 363,719 10/1995 Cindrich et al. D14/216
D. 366,478 1/1996 Daniels et al. D14/114
D. 367,476 2/1996 Martin D14/114
D. 376,364 12/1996 Boothroyd et al. D14/216
D. 379,093 5/1997 Vollum et al. D14/216
D. 380,759 7/1997 Lin D14/215
D. 382,562 8/1997 Leifer D14/190

[21] Appl. No.: **29/083,083**
[22] Filed: **Feb. 4, 1998**

Primary Examiner—M. H. Tung
Attorney, Agent, or Firm—Jacobson, Price, Holman & Stern, PLLC

[30] **Foreign Application Priority Data**
Nov. 27, 1997 [KR] Rep. of Korea 97-25008

[57] CLAIM

The ornamental design for speaker for computer, as shown and described.

[51] **LOC (6) Cl.** **14-01**
[52] **U.S. Cl.** **D14/210; D14/114**
[58] **Field of Search** D14/114, 221, D14/204, 216, 215, 210; 381/300, 332-6, 337, 386; 181/144-8, 153, 157, 198-9

DESCRIPTION

FIG. 1 is a perspective view;
FIG. 2 is a front view;
FIG. 3 is a rear view;
FIG. 4 is a left side view;
FIG. 5 is a right side view;
FIG. 6 is a top plan view; and,
FIG. 7 is a bottom plan view.

[56] **References Cited**
U.S. PATENT DOCUMENTS
D. 359,050 6/1995 Deguchi D14/210

1 Claim, 4 Drawing Sheets

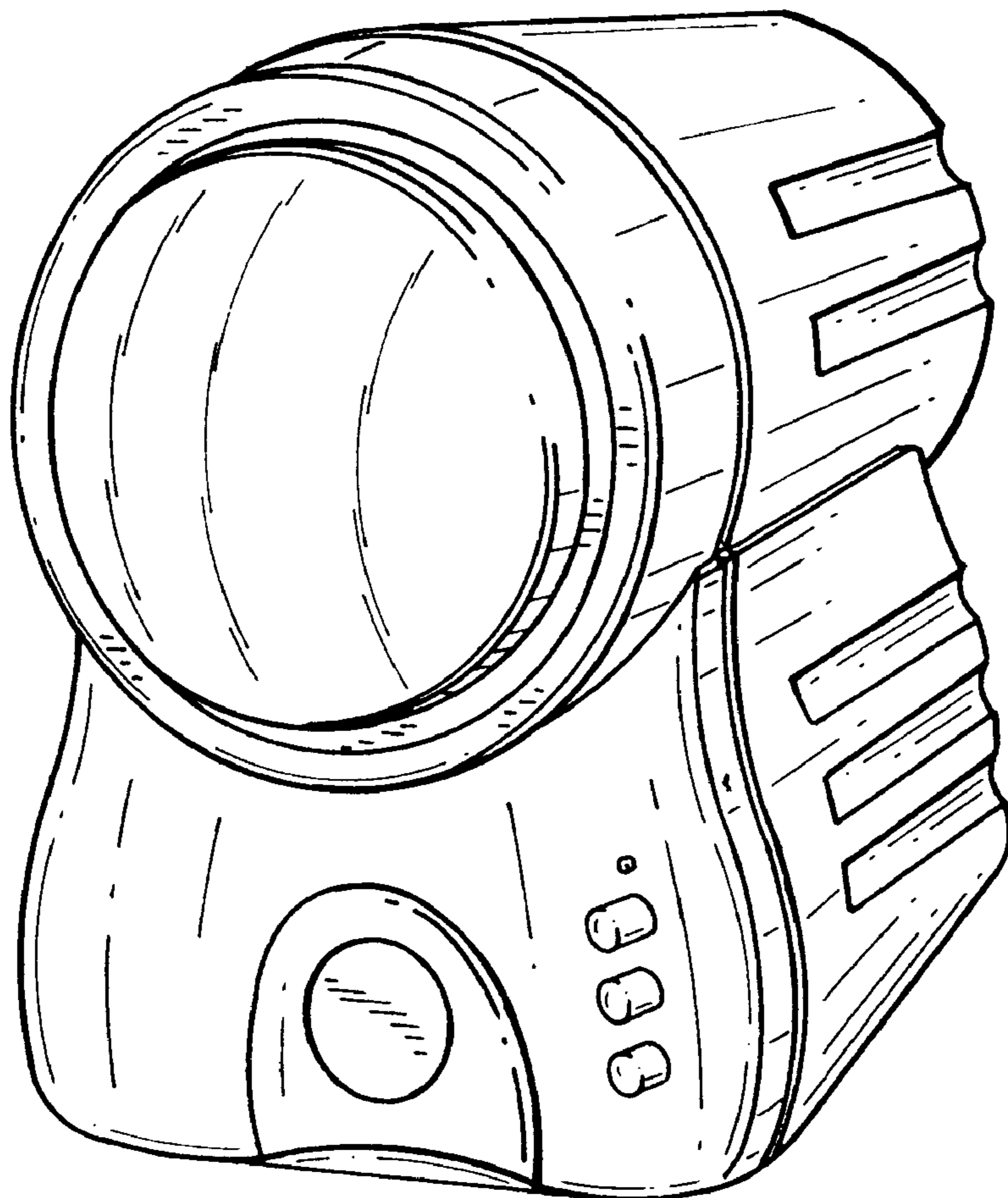

FIG. 1

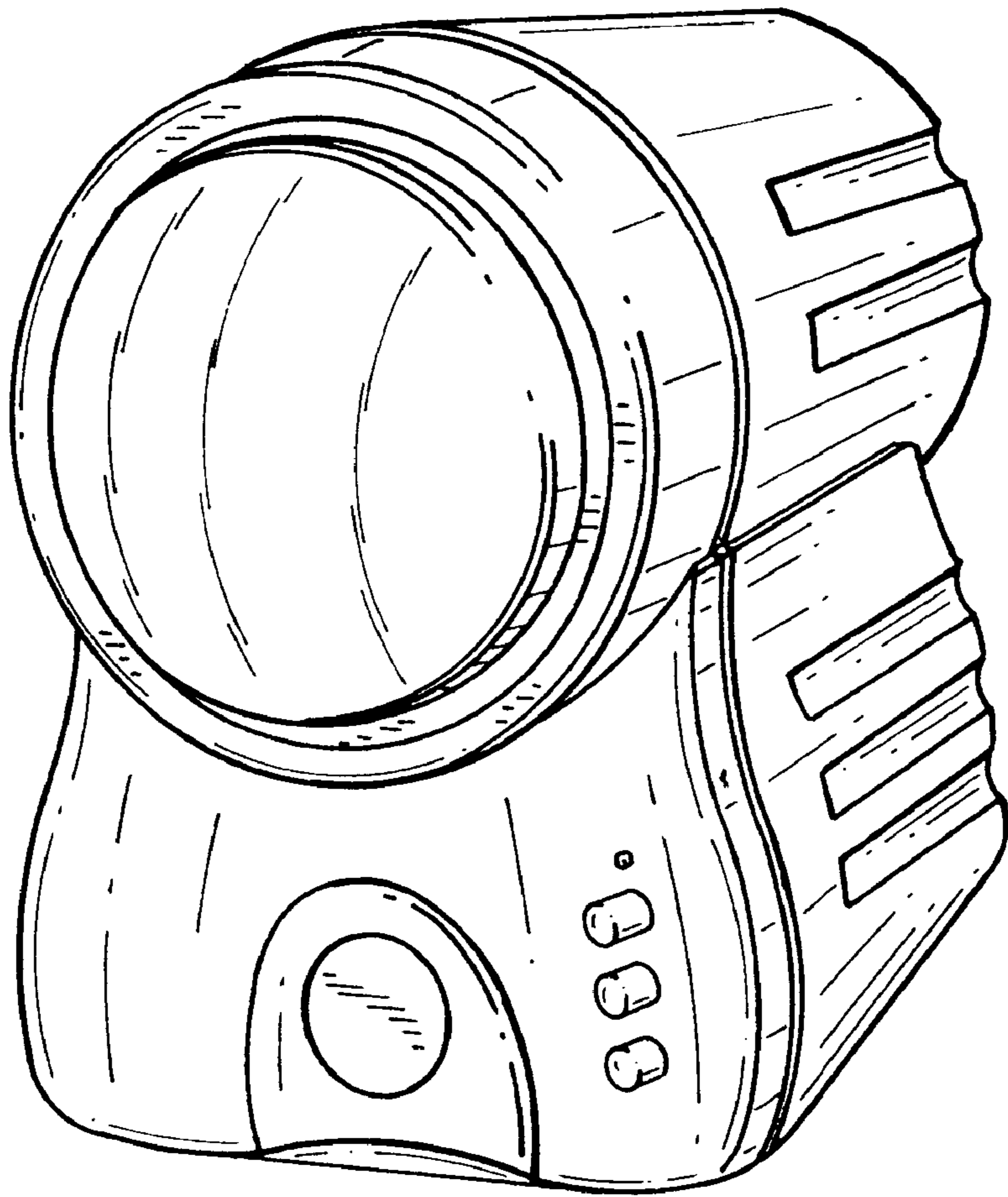

FIG. 2

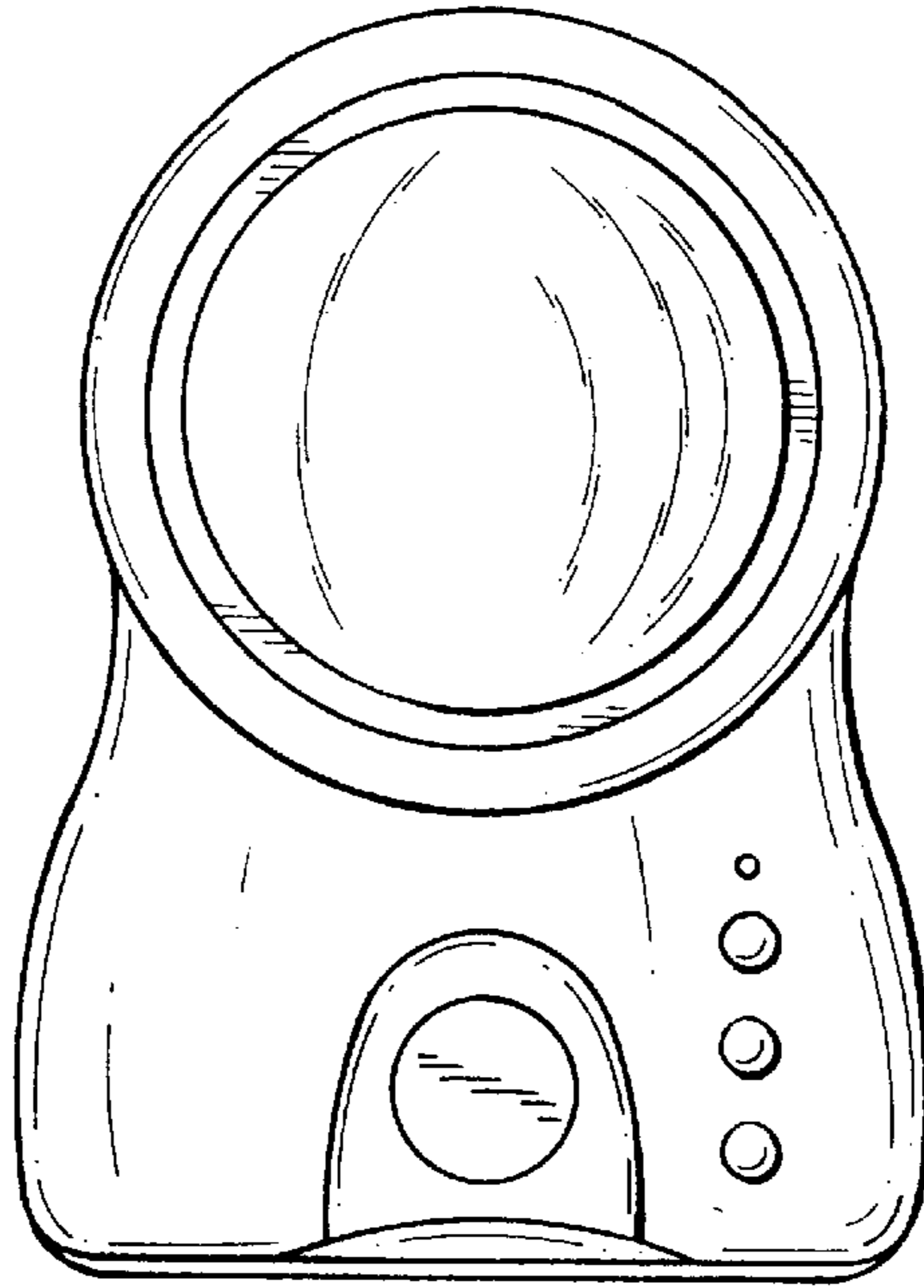

FIG. 3

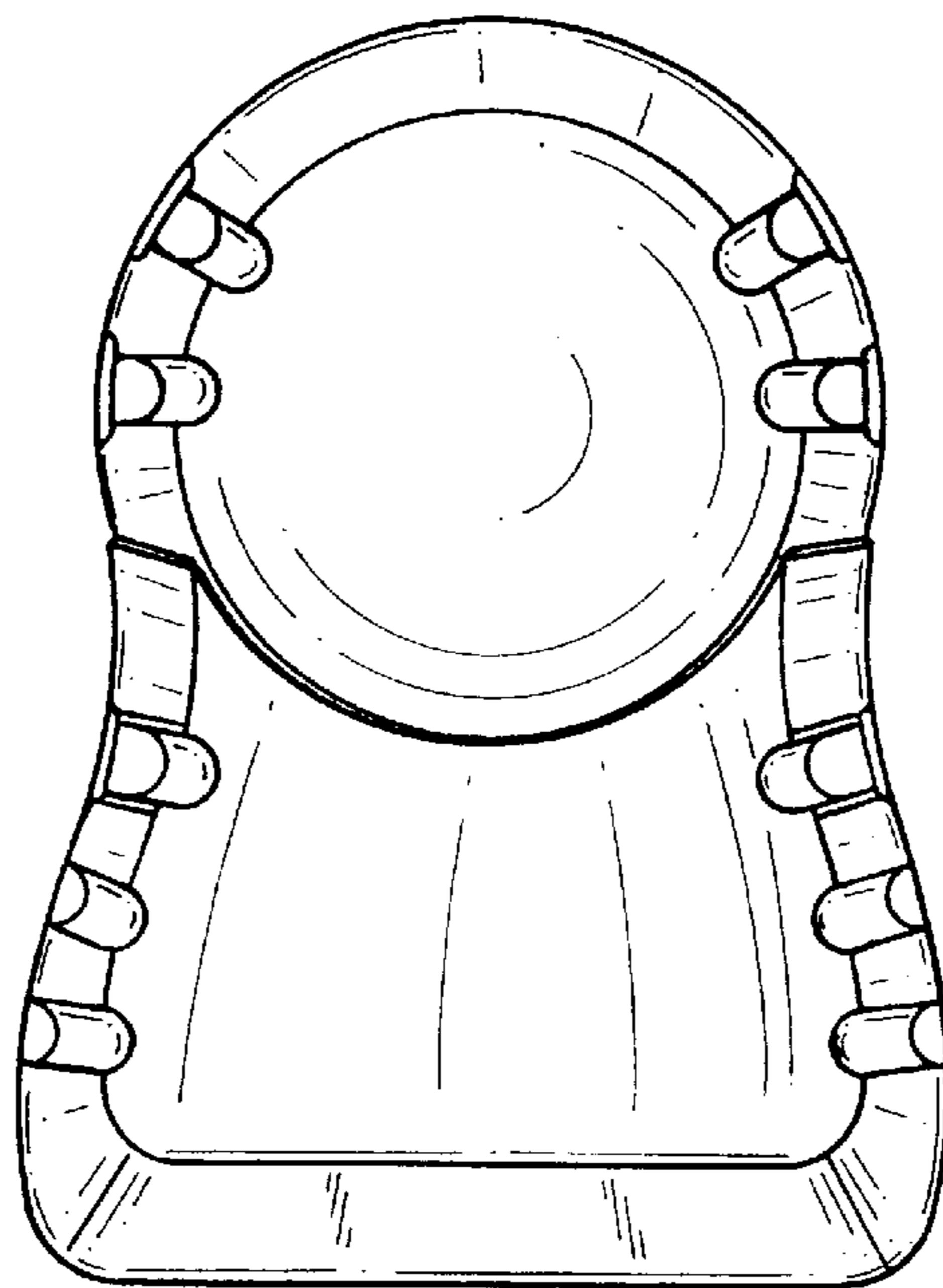

FIG. 4

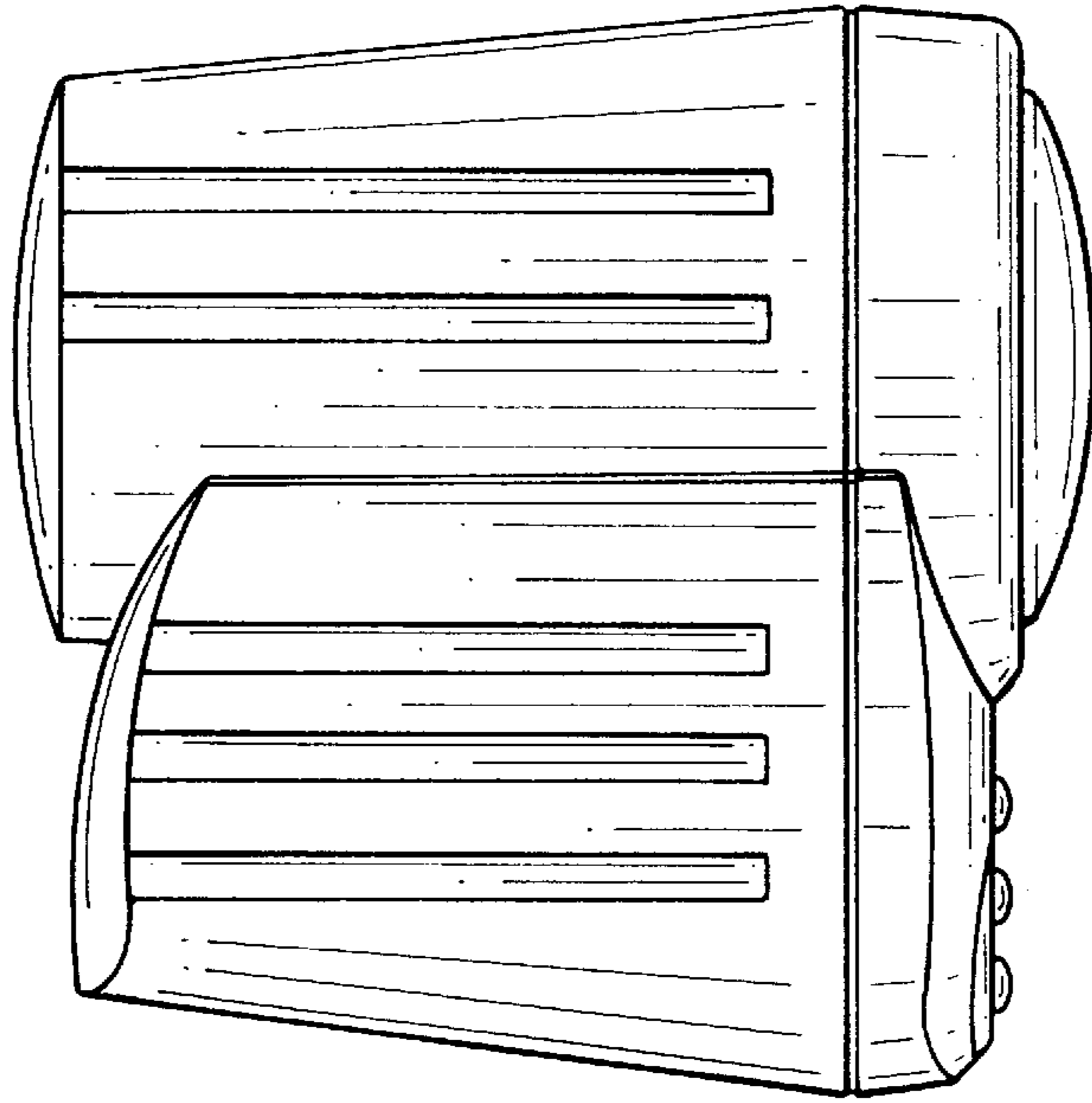

FIG. 5

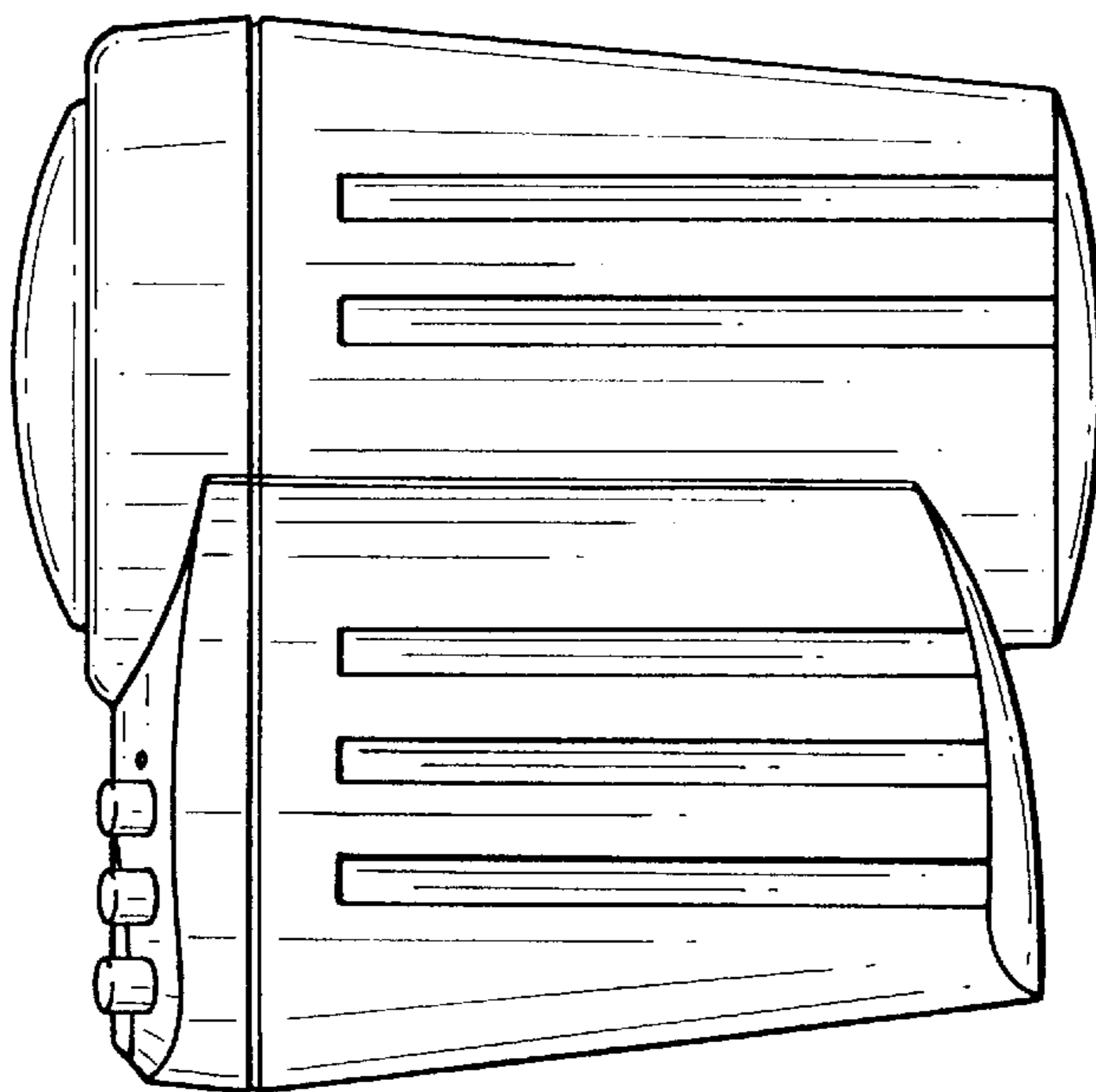

FIG. 6

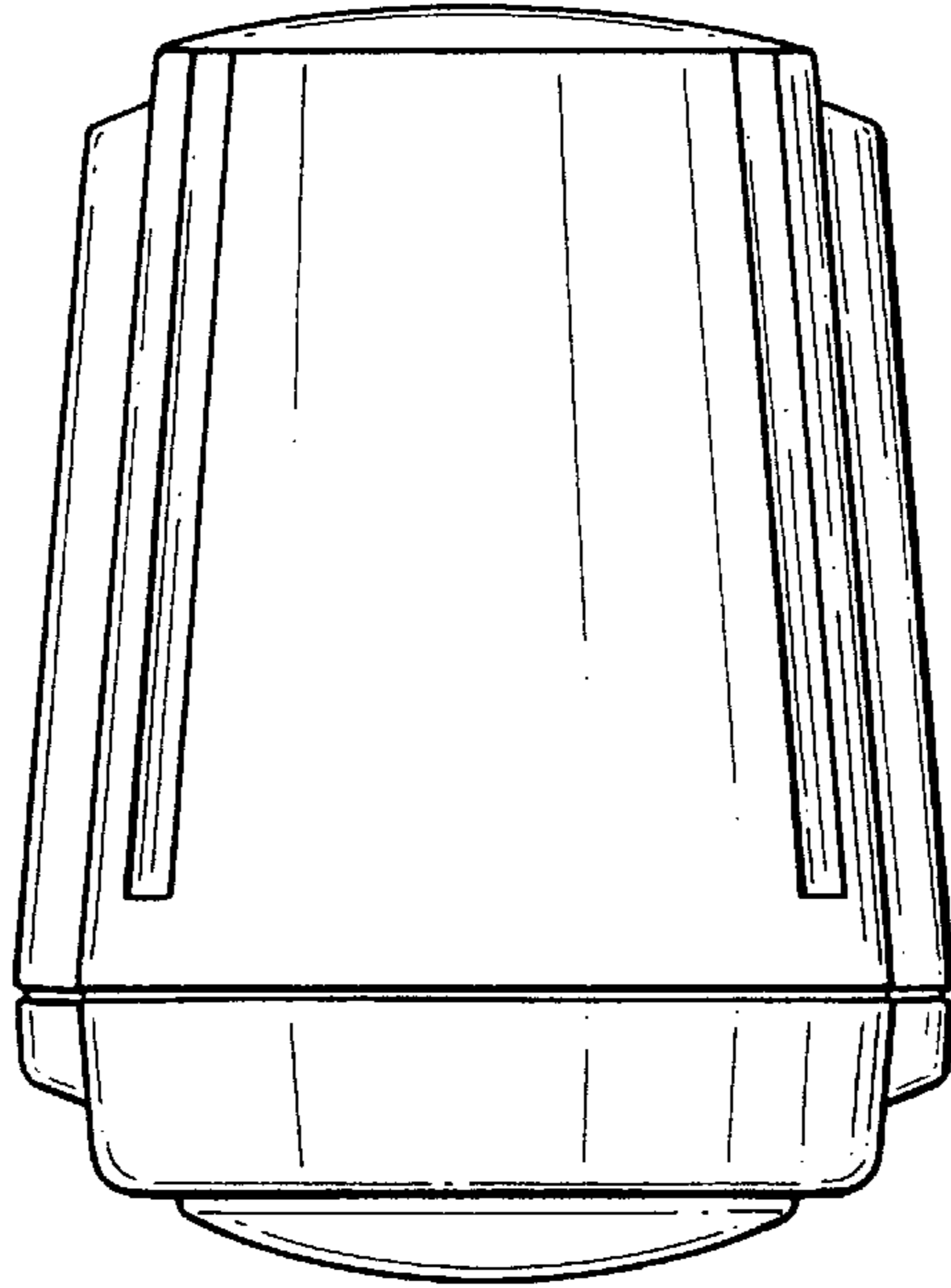

FIG. 7

