



US00D411826S

# United States Patent [19]

Lamar et al.

[11] Patent Number: **Des. 411,826**

[45] Date of Patent: **\*\* Jul. 6, 1999**

[54] **WEATHERPROOF ELECTRICAL ENCLOSURE**

[75] Inventors: **Donald F. Lamar**, Fort Wayne, Ind.;  
**Spencer L. Mackay**, Agoura Hills;  
**Richard F. M. Conroy**, Simi Valley,  
both of Calif.

[73] Assignee: **The Lamar Corporation**, Fort Wayne,  
Ind.

[\*\*] Term: **14 Years**

[21] Appl. No.: **29/087,695**

[22] Filed: **May 7, 1998**

[51] **LOC (6) Cl.** ..... **13-03**

[52] **U.S. Cl.** ..... **D13/139.6; D13/156**

[58] **Field of Search** ..... **D13/139.6, 156,**  
**D13/177; D8/353; D14/240; 220/3.8, 242;**  
**439/367; 174/48, 66, 67**

[56] **References Cited**

**U.S. PATENT DOCUMENTS**

- D. 231,896 6/1974 Zerwes ..... D8/353
- D. 294,798 3/1988 Hoehne ..... D13/156 X

- D. 346,386 4/1994 Brownlie et al. .... D14/240
- D. 378,913 4/1997 Chambers et al. .... D13/156
- D. 379,176 5/1997 Chambers et al. .... D13/156
- D. 379,970 6/1997 Chambers et al. .... D13/156
- 4,505,403 3/1985 Bowden, Jr. et al. .... 220/242

*Primary Examiner*—Doris V. Coles  
*Assistant Examiner*—Cathron B. Matta  
*Attorney, Agent, or Firm*—Baker & Daniels

[57] **CLAIM**

The ornamental design for a weatherproof electrical enclosure, as shown and described.

**DESCRIPTION**

FIG. 1 is a left-front perspective view of the weatherproof electrical enclosure showing our new design; FIG. 2 is a front view thereof; FIG. 3 is a rear view thereof; FIG. 4 is a top view thereof; FIG. 5 is a bottom view thereof; FIG. 6 is a left side view thereof; FIG. 7 is a right side thereof; and, FIG. 8 is a front view of the weatherproof electrical enclosure showing the cover in an open position.

**1 Claim, 4 Drawing Sheets**

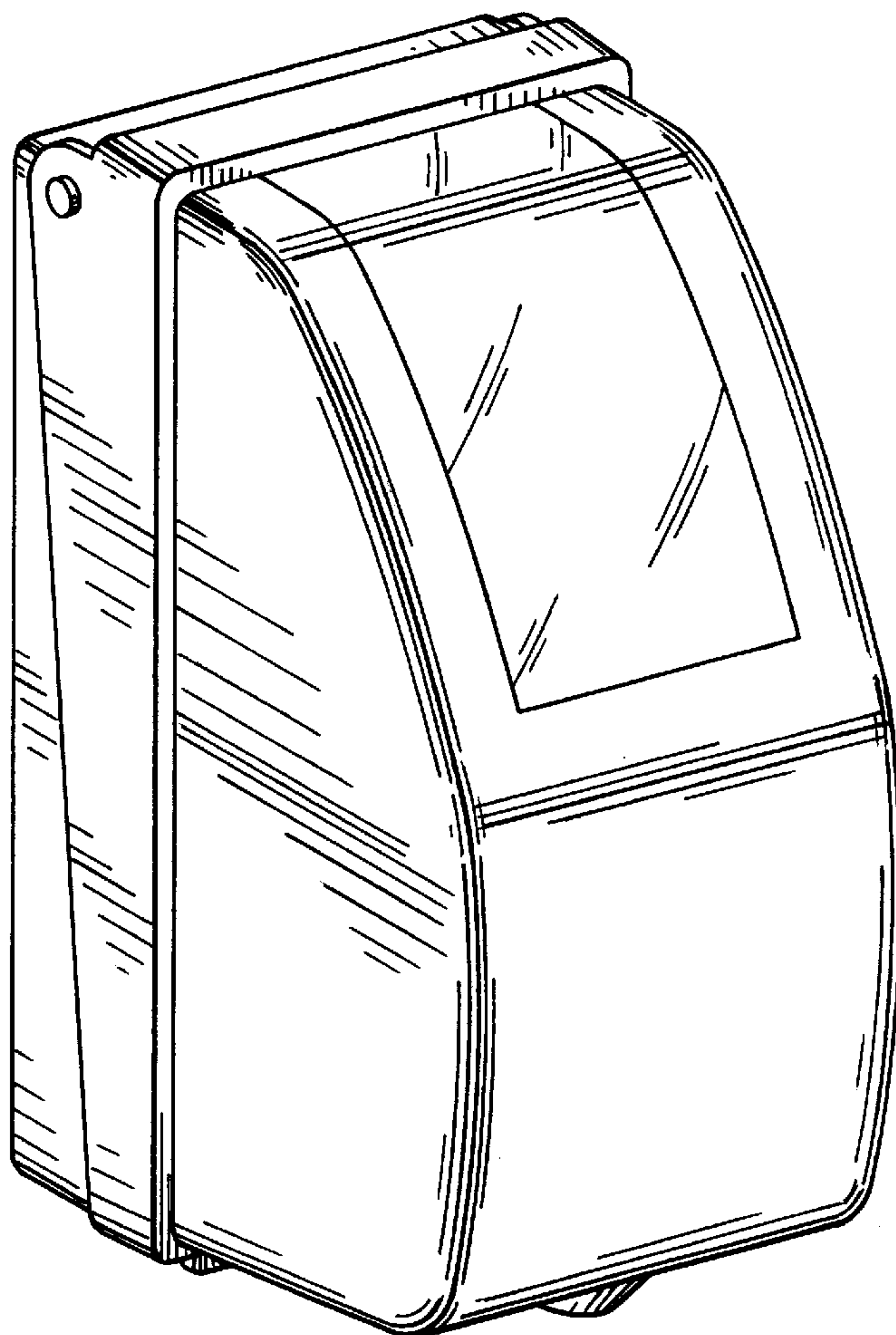

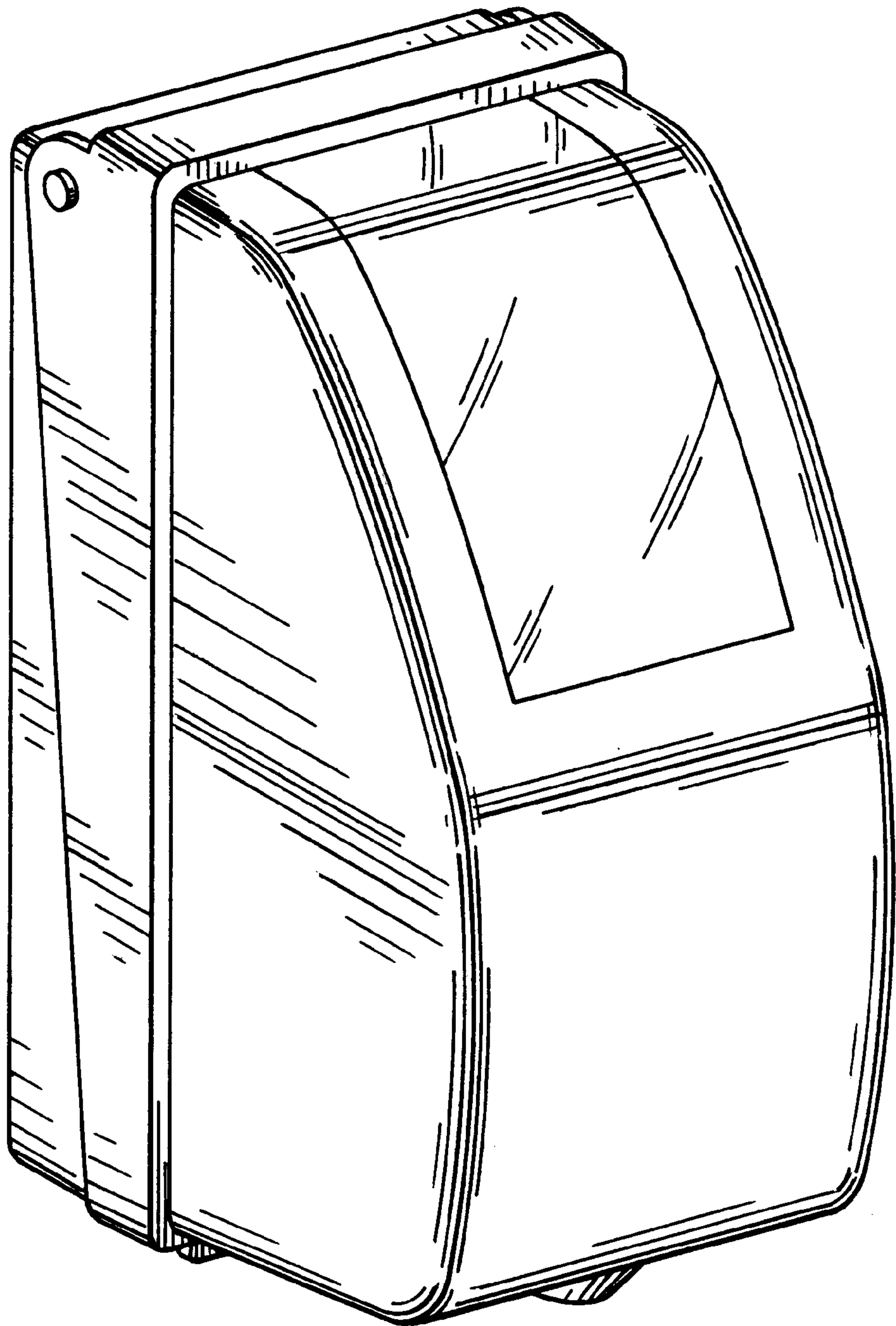

FIG. 1

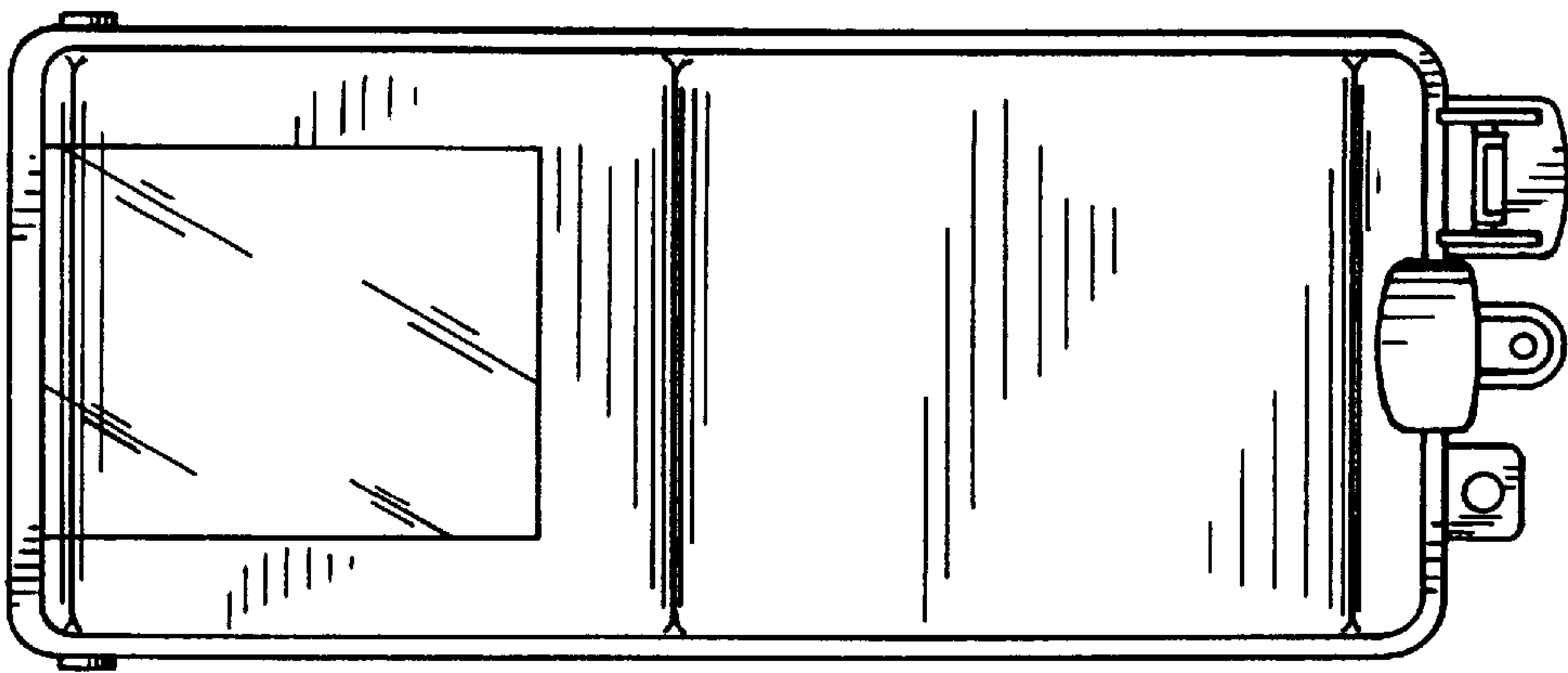

FIG. 2

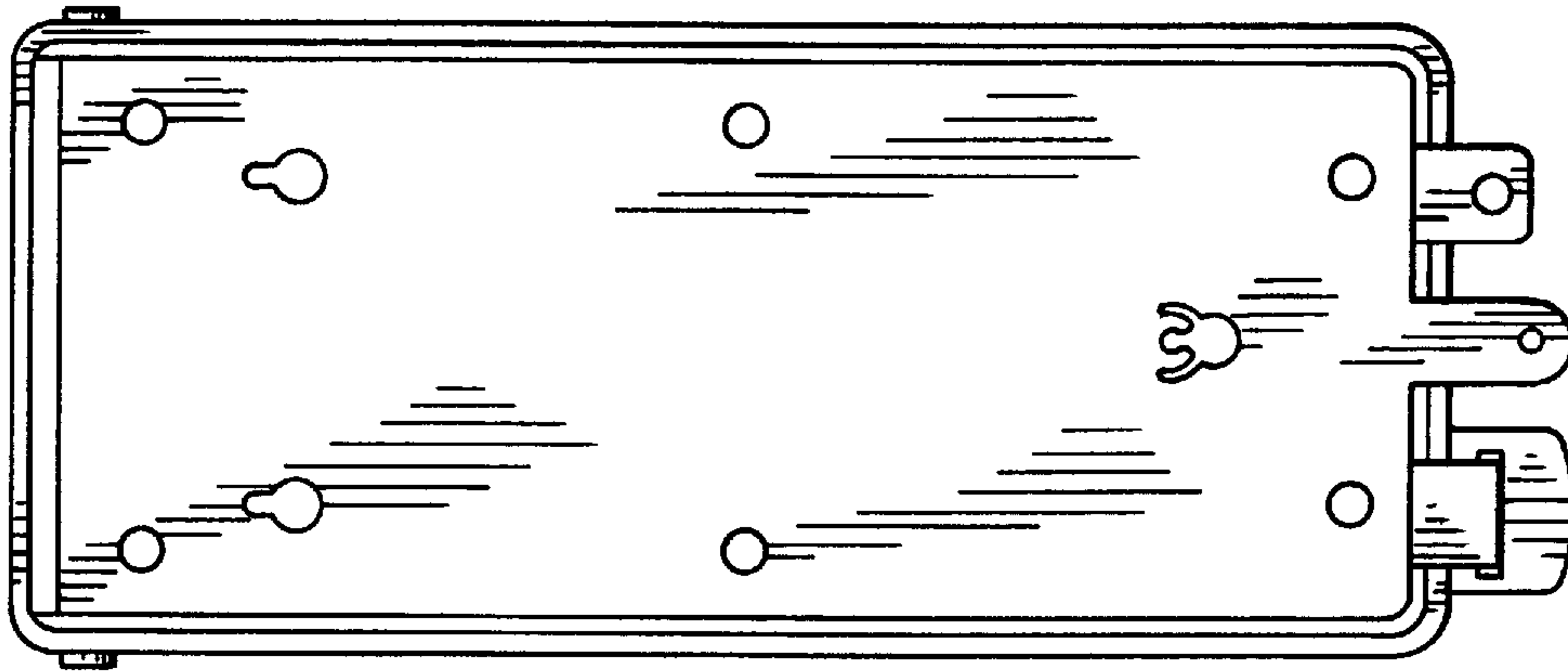

FIG. 3

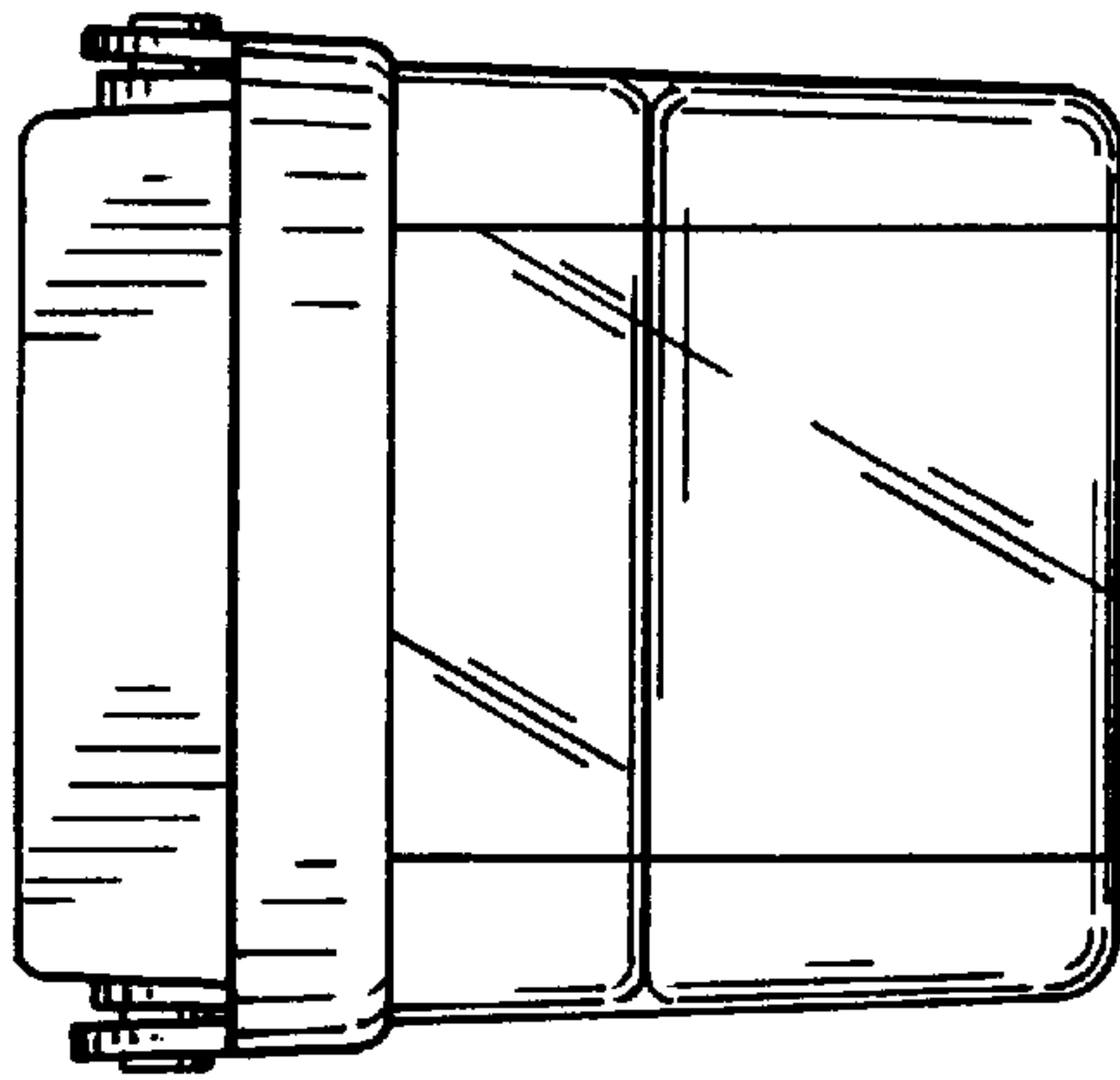

FIG. 4

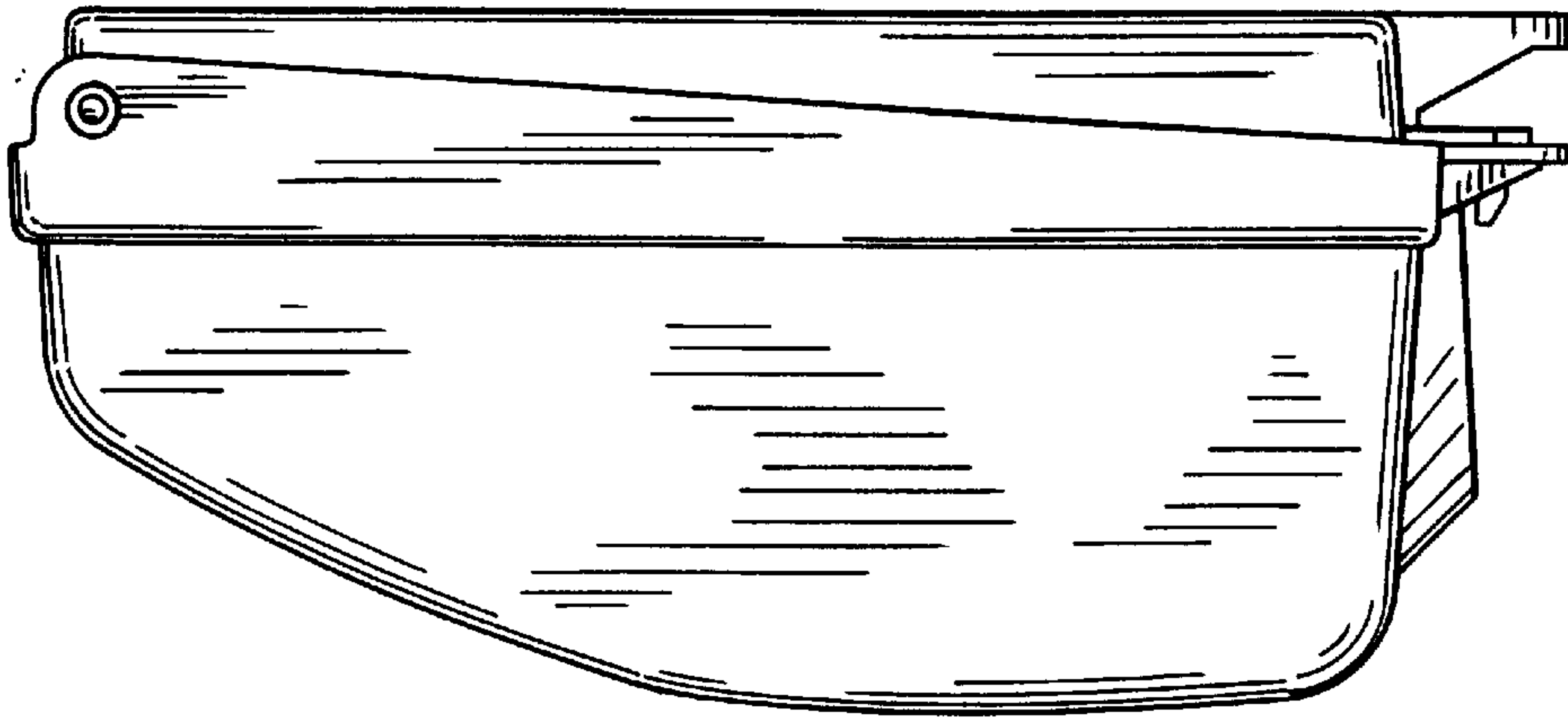

FIG. 7

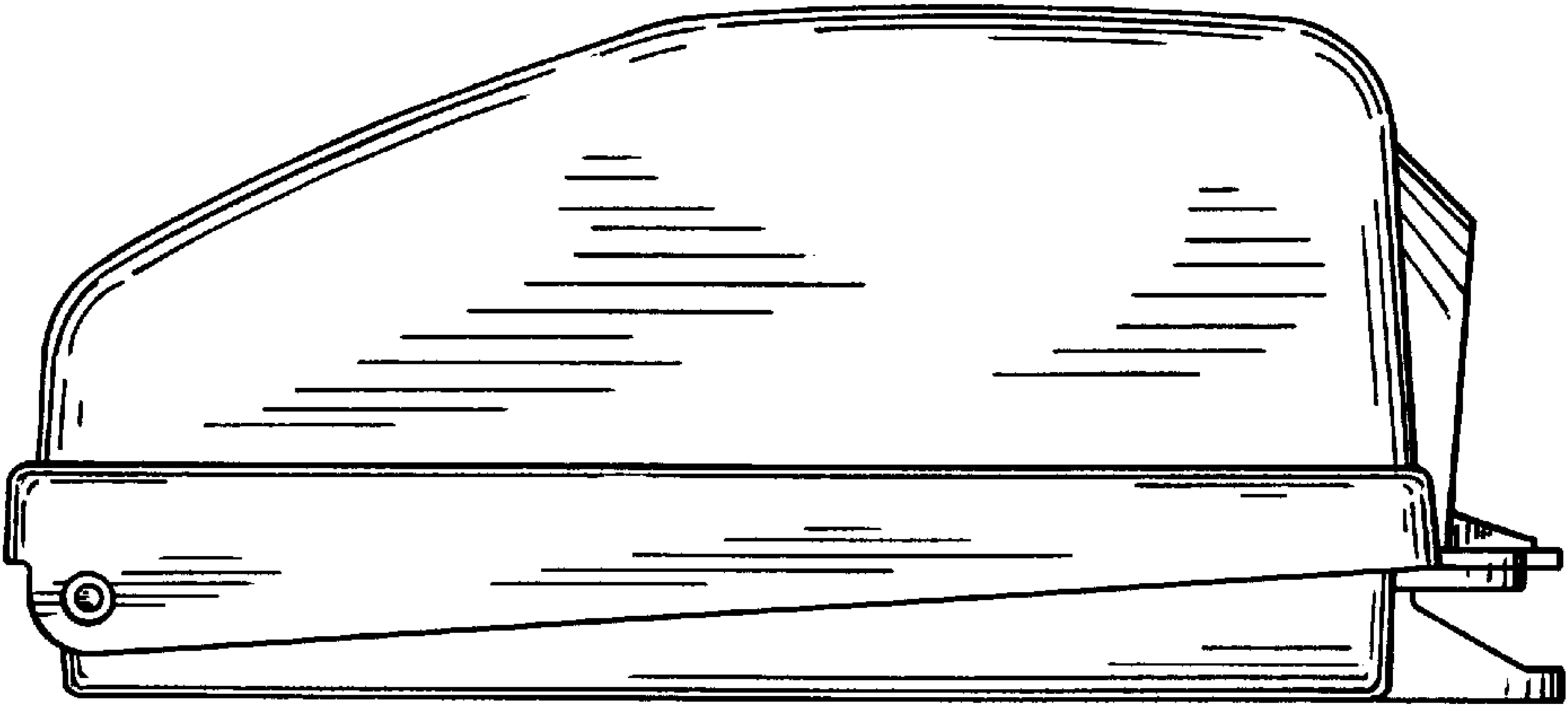

FIG. 6

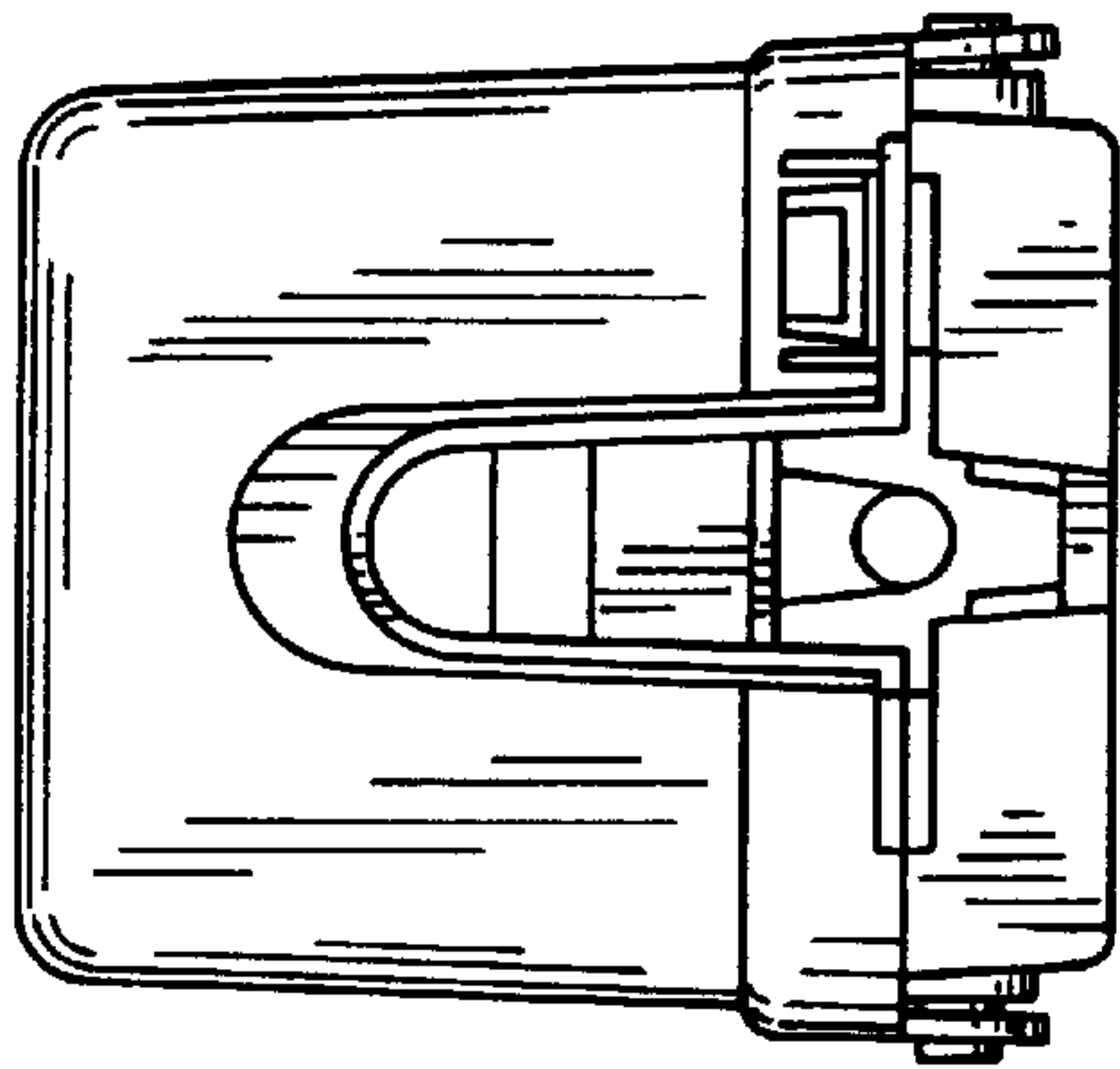

FIG. 5

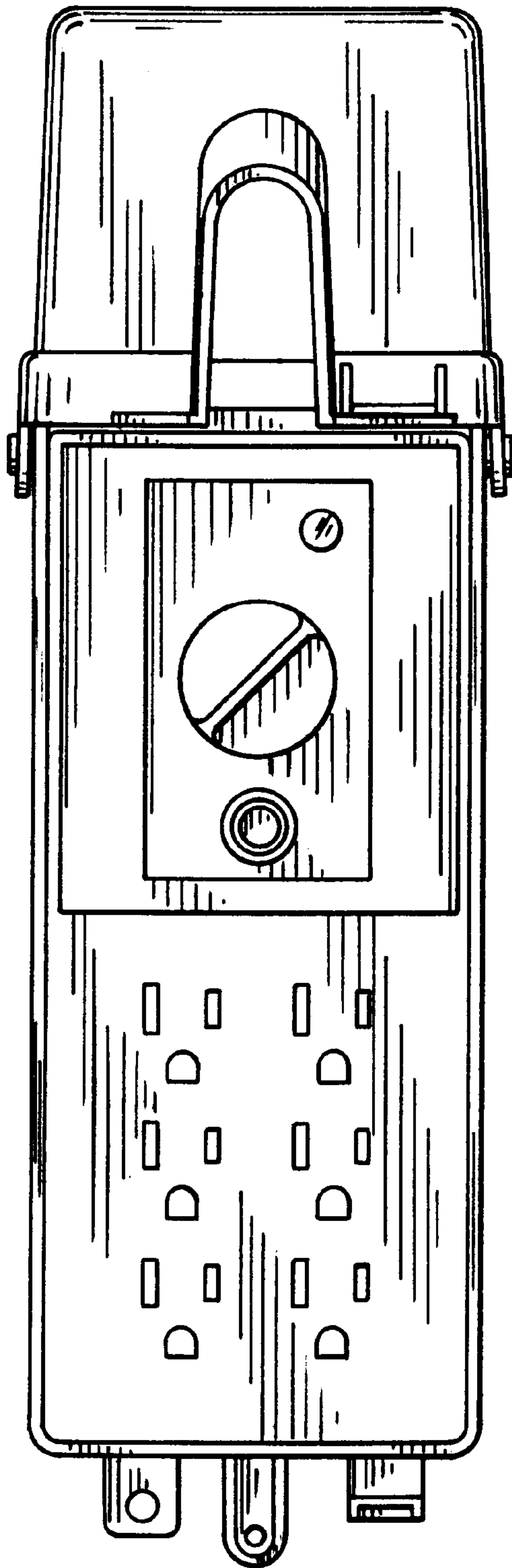

FIG. 8