



US00D411713S

United States Patent [19] Bridges

[11] Patent Number: Des. 411,713

[45] Date of Patent: ** Jun. 29, 1999

[54] BEVERAGE MUG WITH LID

[75] Inventor: John A. Bridges, Nashville, Tenn.

[73] Assignee: Aladdin Industries, Inc., Nashville, Tenn.

[**] Term: 14 Years

[21] Appl. No.: 29/095,525

[22] Filed: Oct. 26, 1998

[51] LOC (6) Cl. 07-01

[52] U.S. Cl. D7/536; D7/510; D7/511

[58] Field of Search D7/535, 534, 503,
D7/509, 510, 511, 533, 536; 206/517, 519;
270/713, 714; 215/229

[56] References Cited

U.S. PATENT DOCUMENTS

D. 263,916	4/1982	Reece	D7/536
D. 289,955	5/1987	Buist	D7/566
D. 338,591	8/1993	Wyatt et al.	.	
D. 362,156	9/1995	Goto et al.	D7/511
D. 362,369	9/1995	Bridges	D7/536
D. 363,414	10/1995	Goto et al.	D7/533
D. 363,641	10/1995	Goto et al.	D7/511
D. 363,642	10/1995	Goto et al.	D7/511
D. 363,665	10/1995	Goto et al.	.	
D. 363,666	10/1995	Goto et al.	D9/449
D. 366,186	1/1996	Kato	D7/536
D. 366,597	1/1996	Smith et al.	D7/536
D. 369,063	4/1996	Meisner	D7/533
D. 371,936	7/1996	Goto et al.	D7/523
D. 372,839	8/1996	Laib	D7/536
D. 382,174	8/1997	Grimm	D7/510
D. 384,860	10/1997	Trombly	D7/536
D. 398,815	9/1998	Hatsumoto et al.	D7/533
D. 401,809	12/1998	Reed	D7/510
5,154,306	10/1992	Wyatt	.	
5,186,353	2/1993	Ramsey	220/713 X
5,294,014	3/1994	Wyatt et al.	.	
5,312,013	5/1994	Bridges	.	
5,415,312	5/1995	Mueller	.	

OTHER PUBLICATIONS

- Aladdin ® "Stanley ® Insulated Travel Mug" brochure, 1995.
- Aladdin ® "Stanley ® Newspaper Ad Slicks" brochure, 1995.
- Aladdin ® "Foam Insulated Mugs" brochure, 1995.
- Aladdin ® "Car Go" brochure, 1995 (2 pp.).
- Aladdin ® "Chill Out" brochure, 1995 (2 pp.).
- Aladdin ® "10 'N 10" brochure, 1995 (pp. 1-8 and cover page).
- Aladdin ® "Don't Loose Your Temperature!", 1993.
- Aladdin ® "Good Taste Comes in All Sizes", 1993.
- Aladdin ® "Customized Beverageware", 1995.
- "Insulated Travel Mugs for Spring/Summer" brochure, 1995.
- "The Traveller™ Car Mug" Brochure, 1995.
- "1996 Centennial Olympic Collection" brochure, 1995.

Primary Examiner—M. N. Pandozzi
Attorney, Agent, or Firm—Greenblum & Bernstein P.L.C.

[57] CLAIM

The ornamental design for a beverage mug with lid, as shown and described.

DESCRIPTION

FIG. 1 is a perspective view of a beverage mug with lid showing my new design;
 FIG. 2 is an exploded perspective view thereof;
 FIG. 3 is a left side elevational view thereof;
 FIG. 4 is a top plan view thereof;
 FIG. 5 is a rear elevational view thereof;
 FIG. 6 is a cross-sectional view thereof taken along line 6—6 of FIG. 5 showing the handle porting with the rest of the mug and lid portion removed for ease illustration;
 FIG. 7 is a right side elevational view of a Beverage Mug with Lid;
 FIG. 8 is a cross-sectional view thereof taken along line 8—8 of FIG. 4 showing the lid portion with the rest of the mug removed for ease of illustration.
 FIG. 9 is a bottom plan view of a beverage mug with lid;
 FIG. 10 is a perspective view thereof, taken from the side opposite that of FIG. 1; and,
 FIG. 11 is a perspective view thereof with the closure disk removed for ease of illustration.

1 Claim, 7 Drawing Sheets

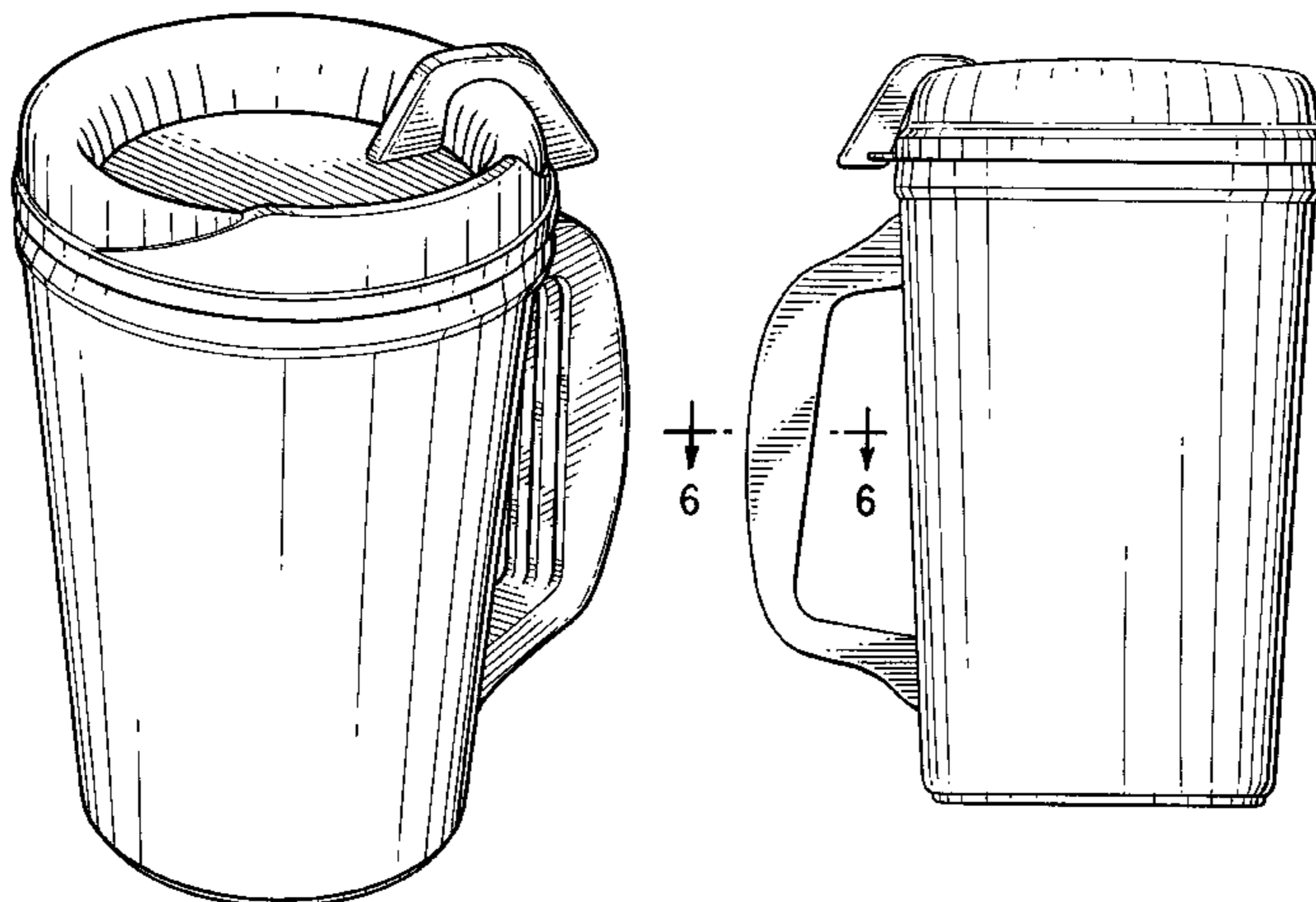

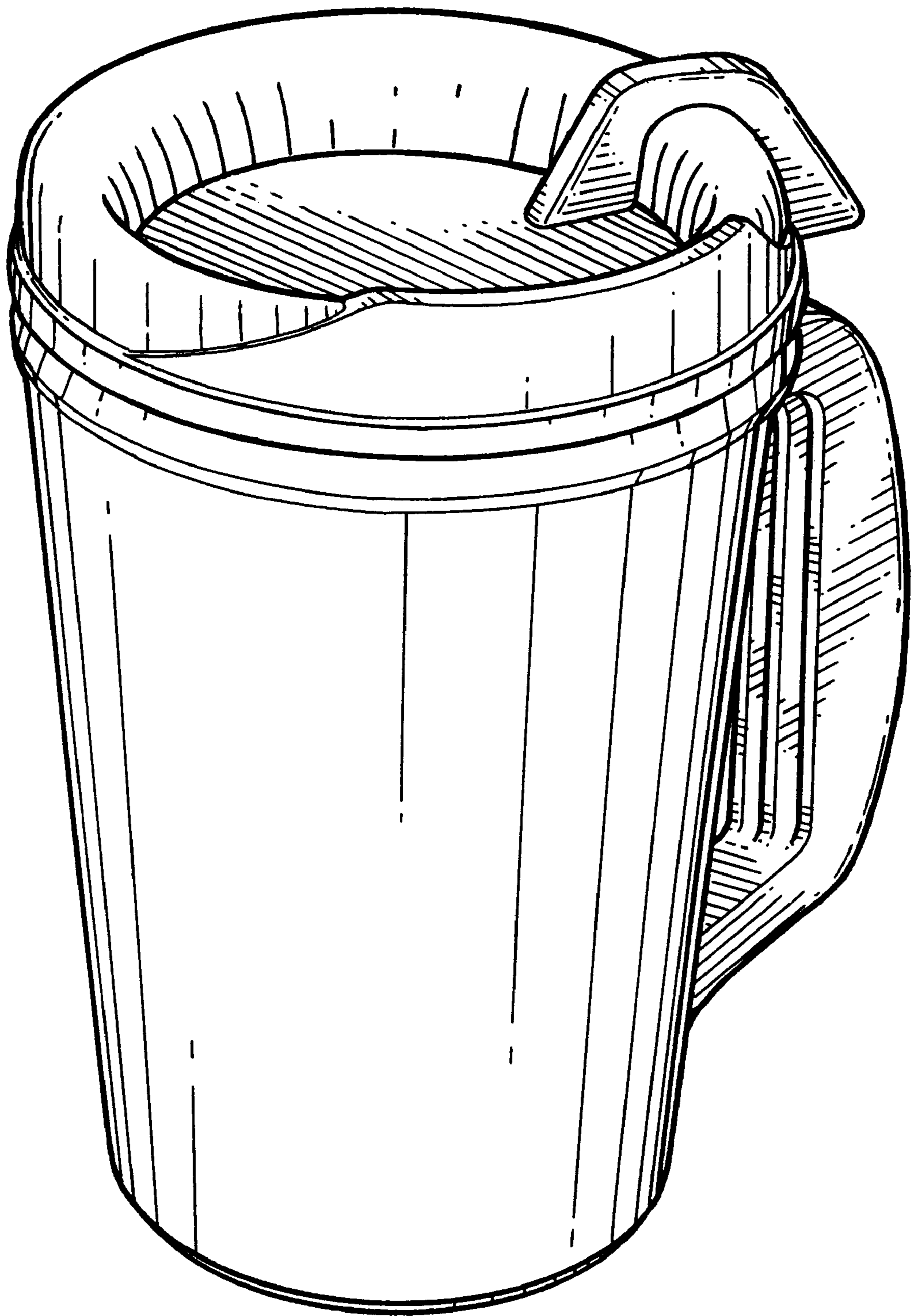

FIG. 1

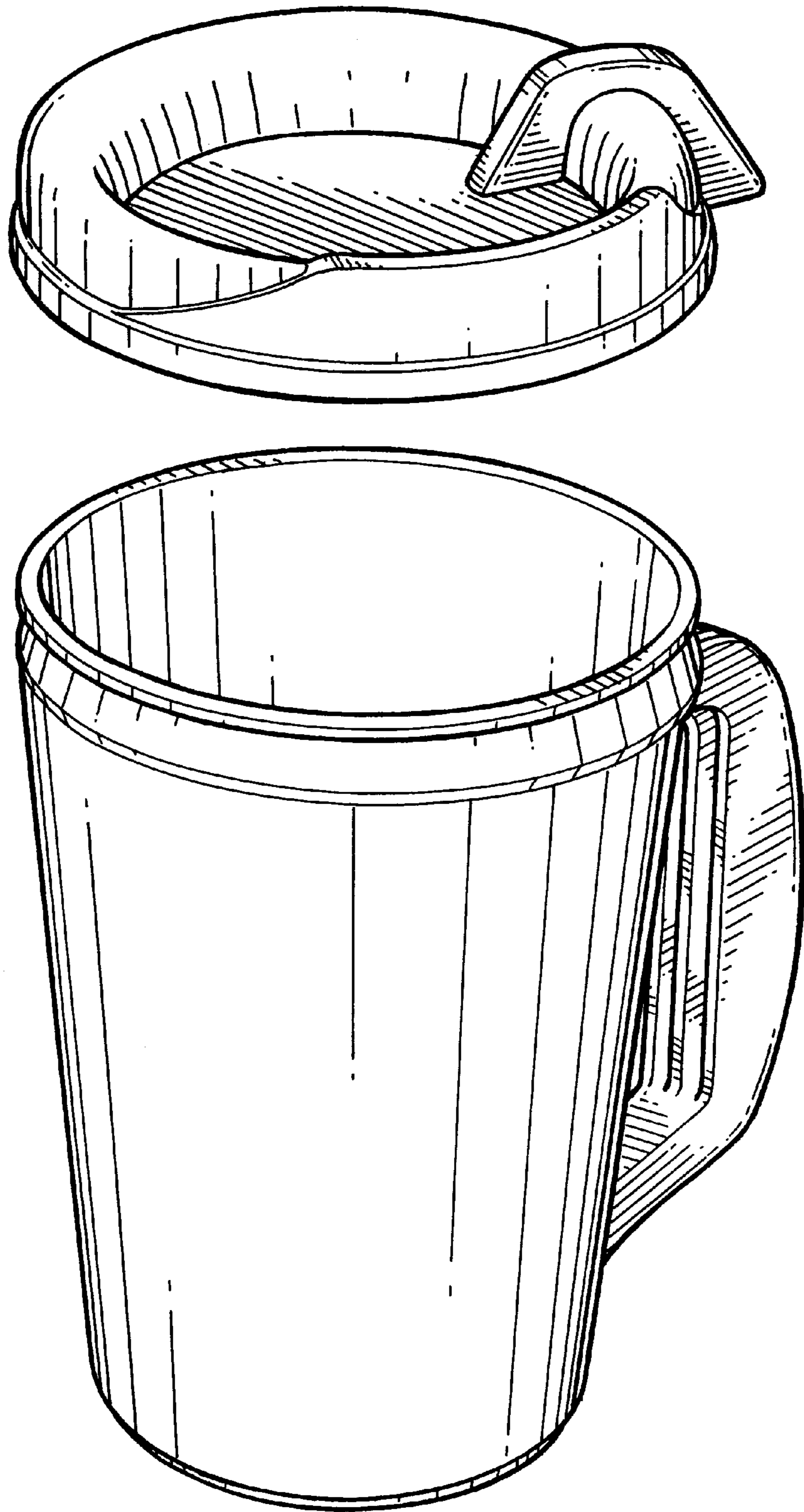

FIG. 2

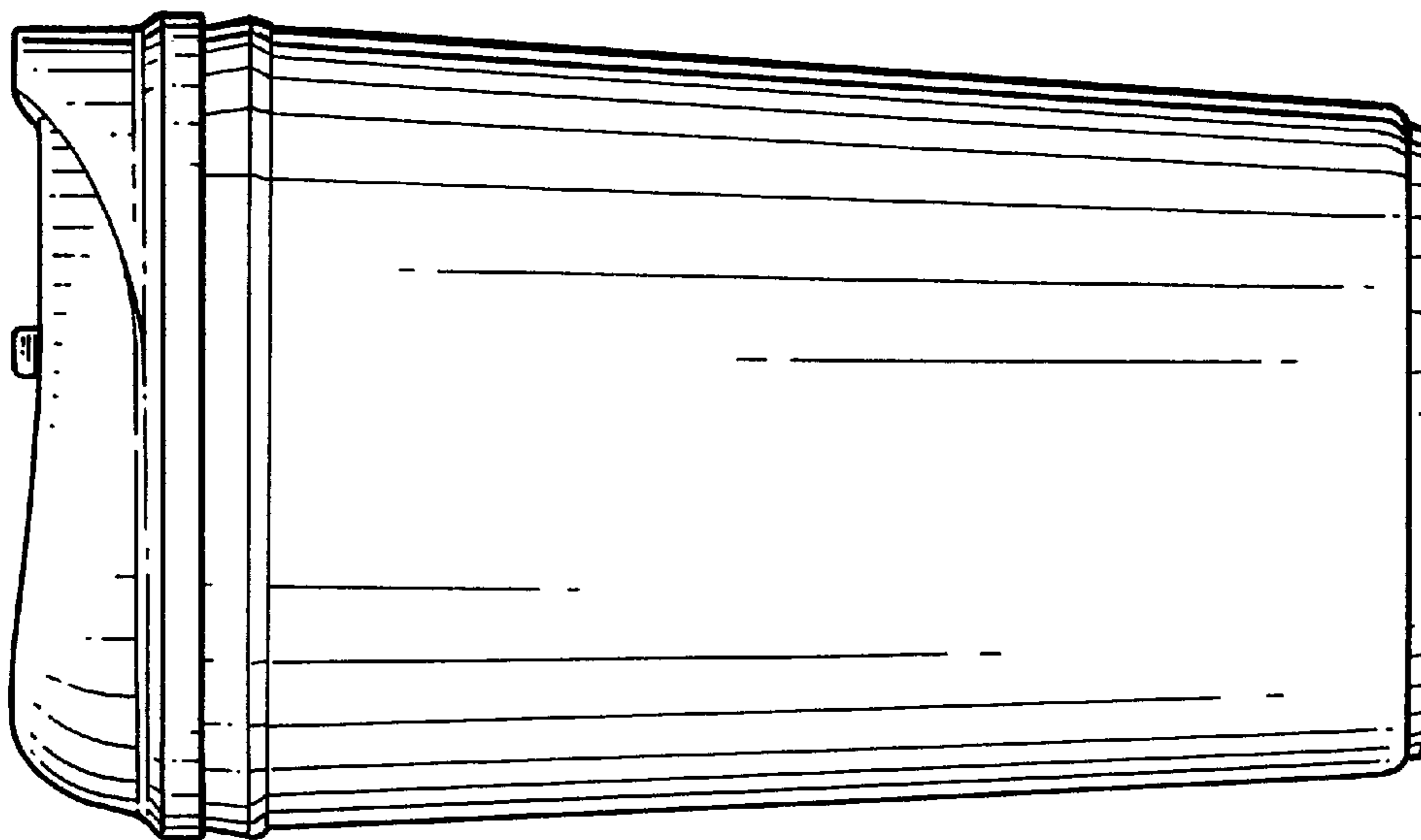

FIG. 3

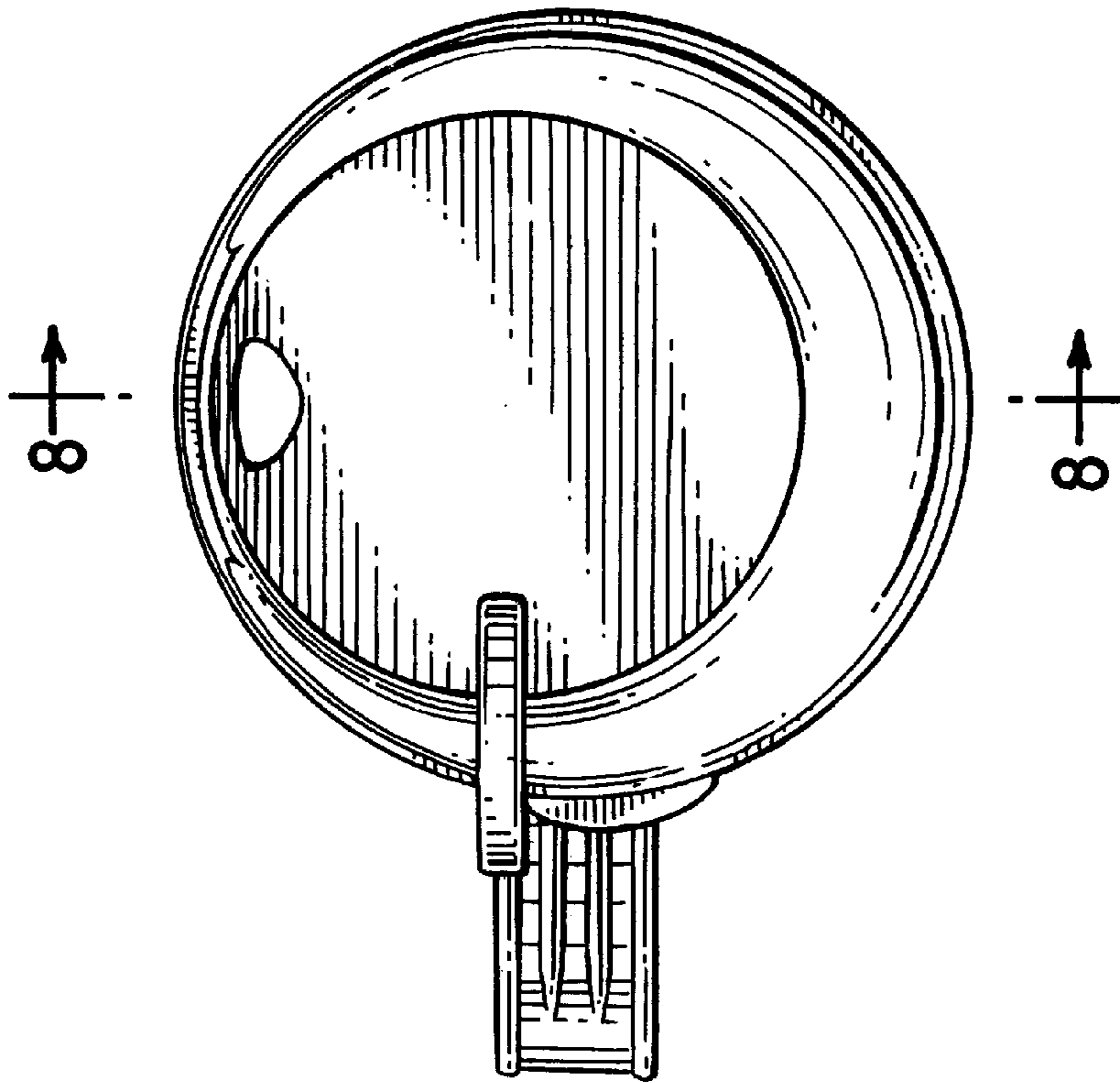

FIG. 4

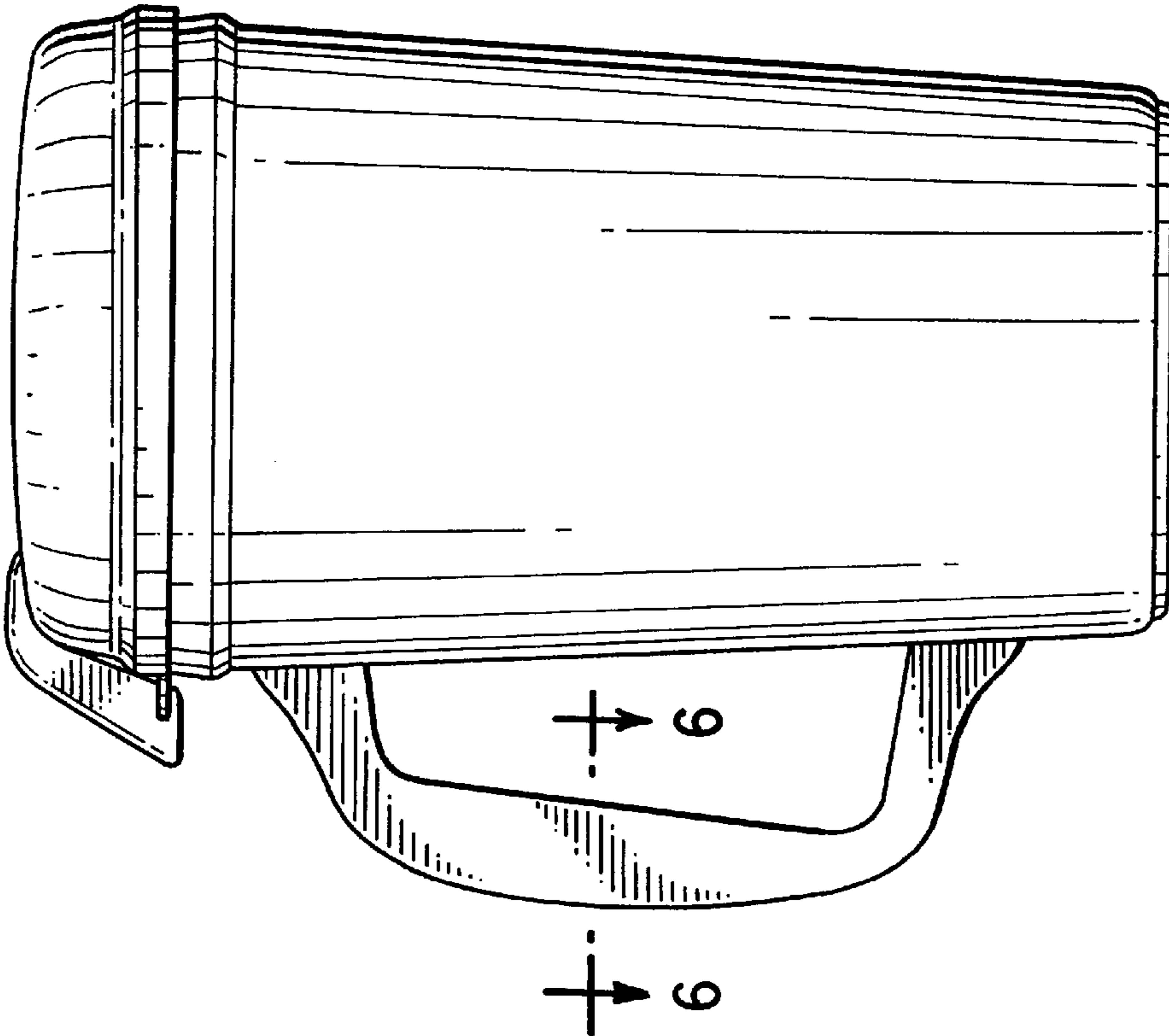

FIG. 5



FIG. 6

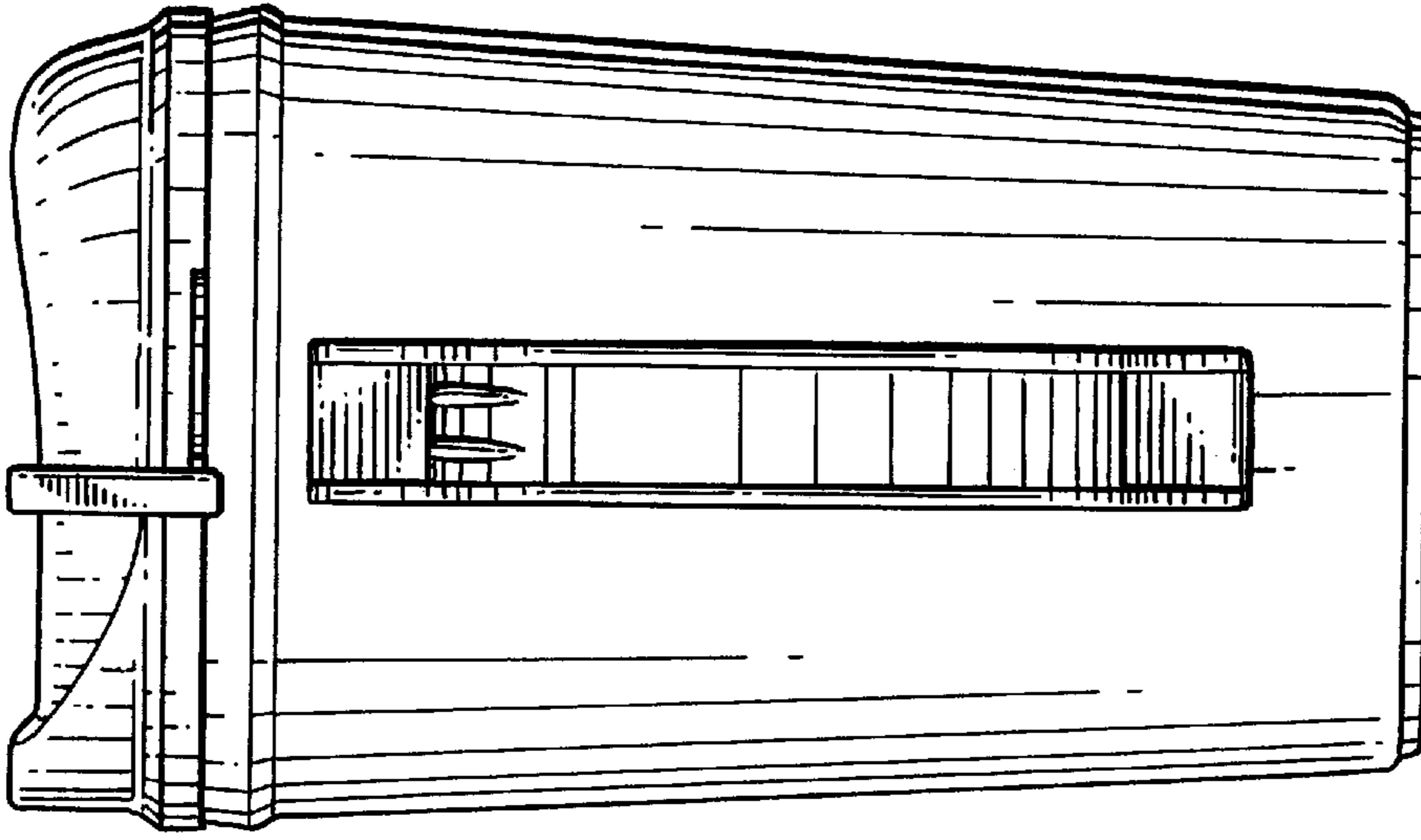

FIG. 7

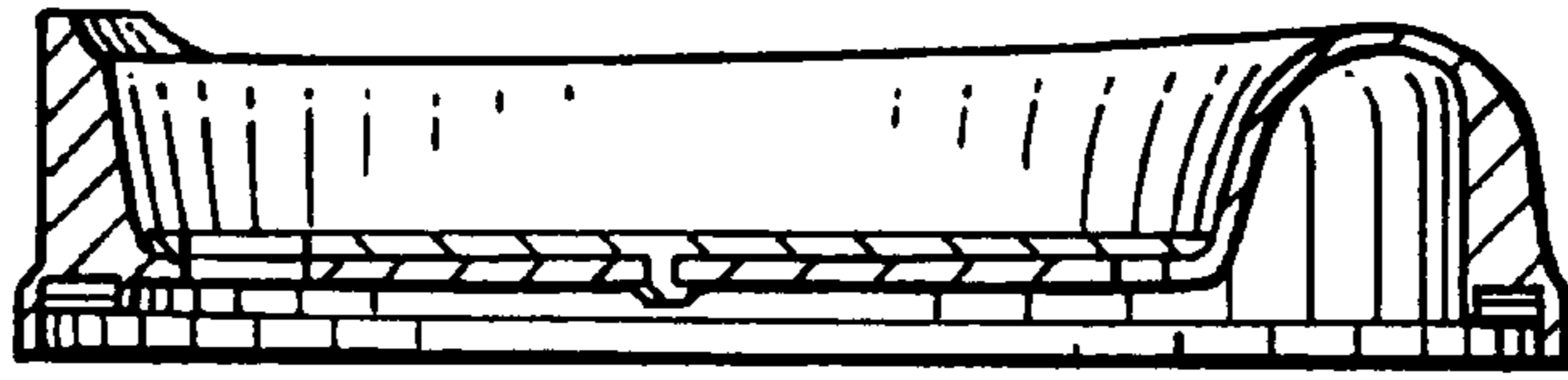

FIG. 8

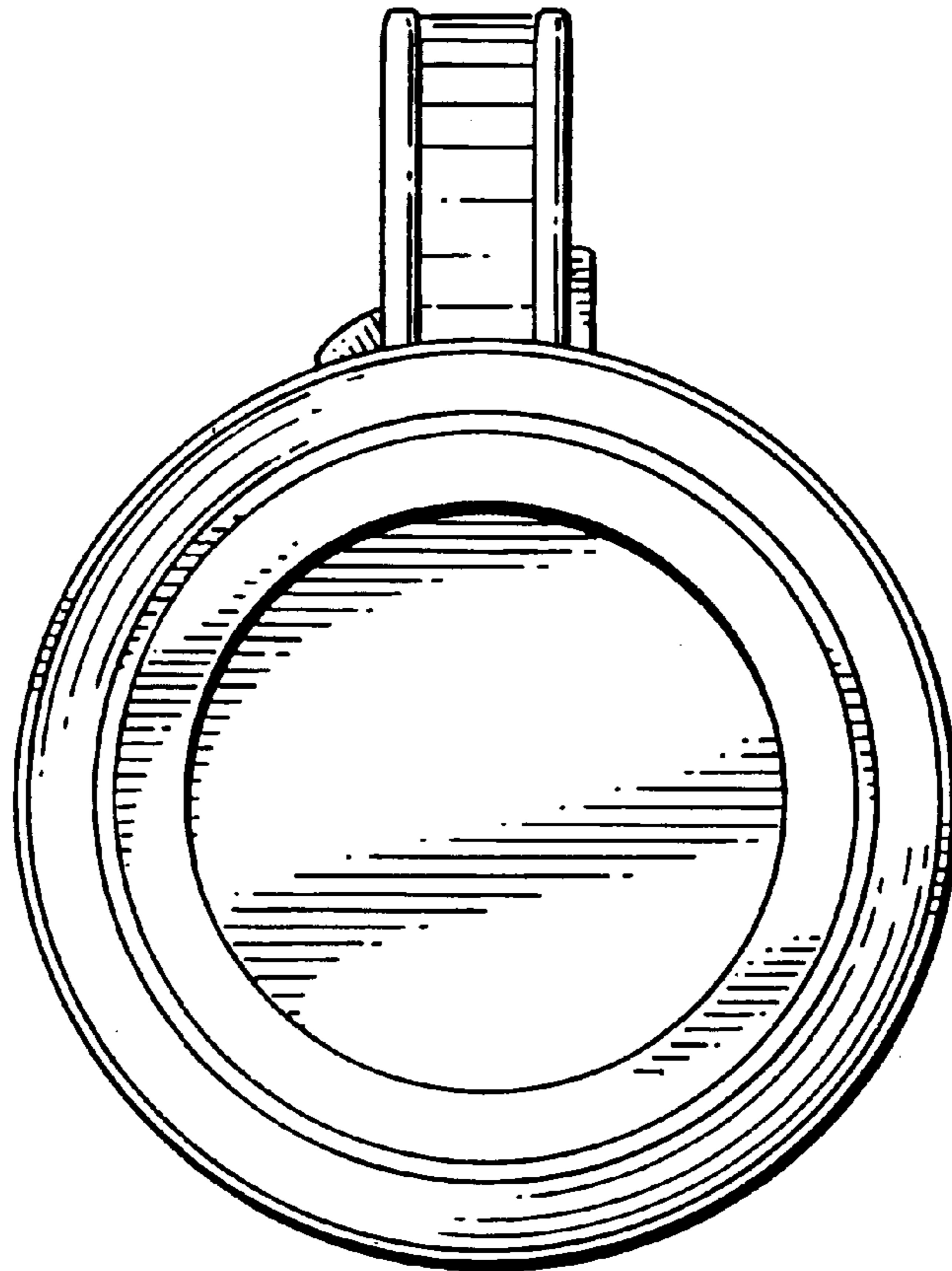

FIG. 9

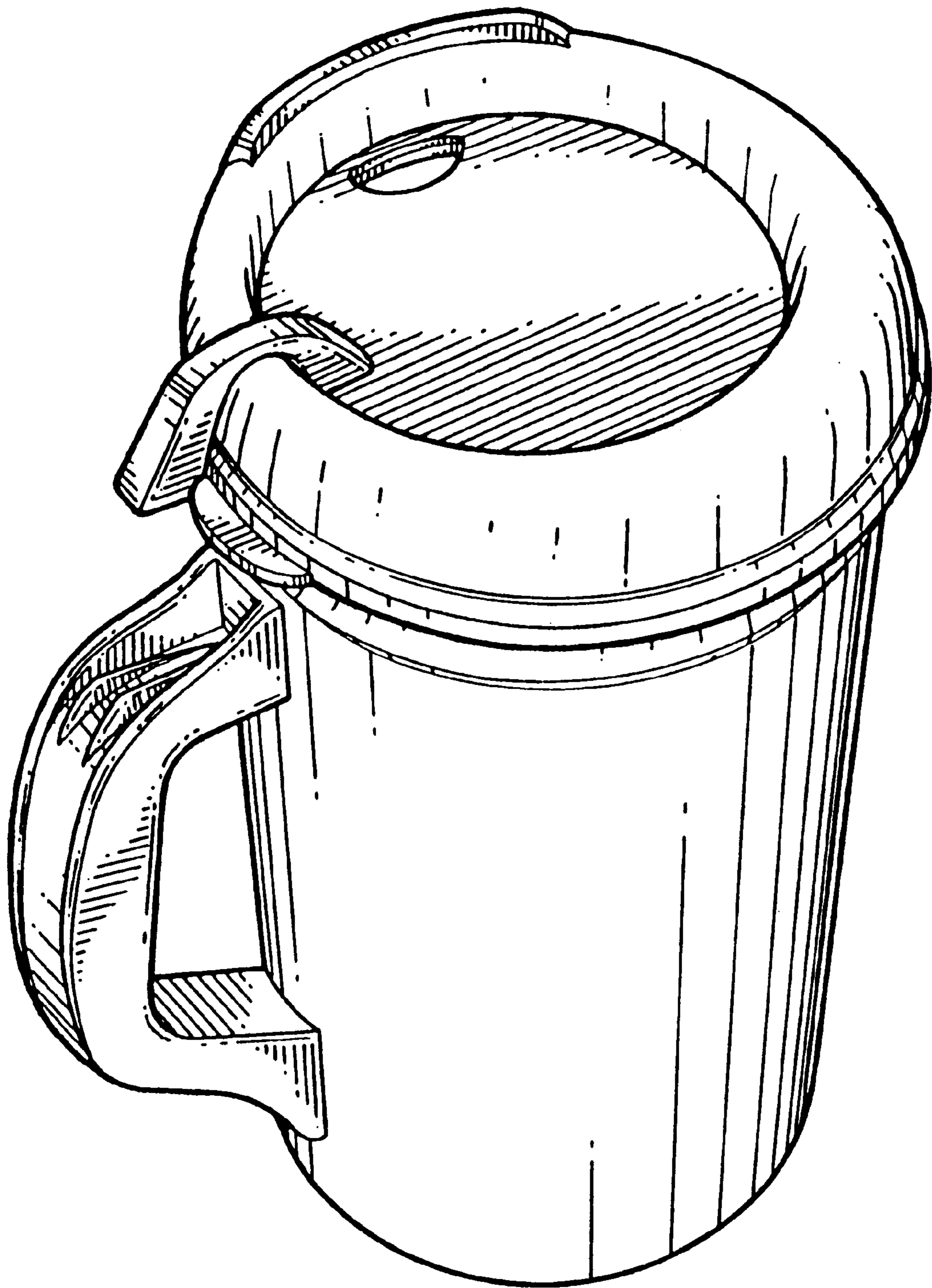

FIG. 10

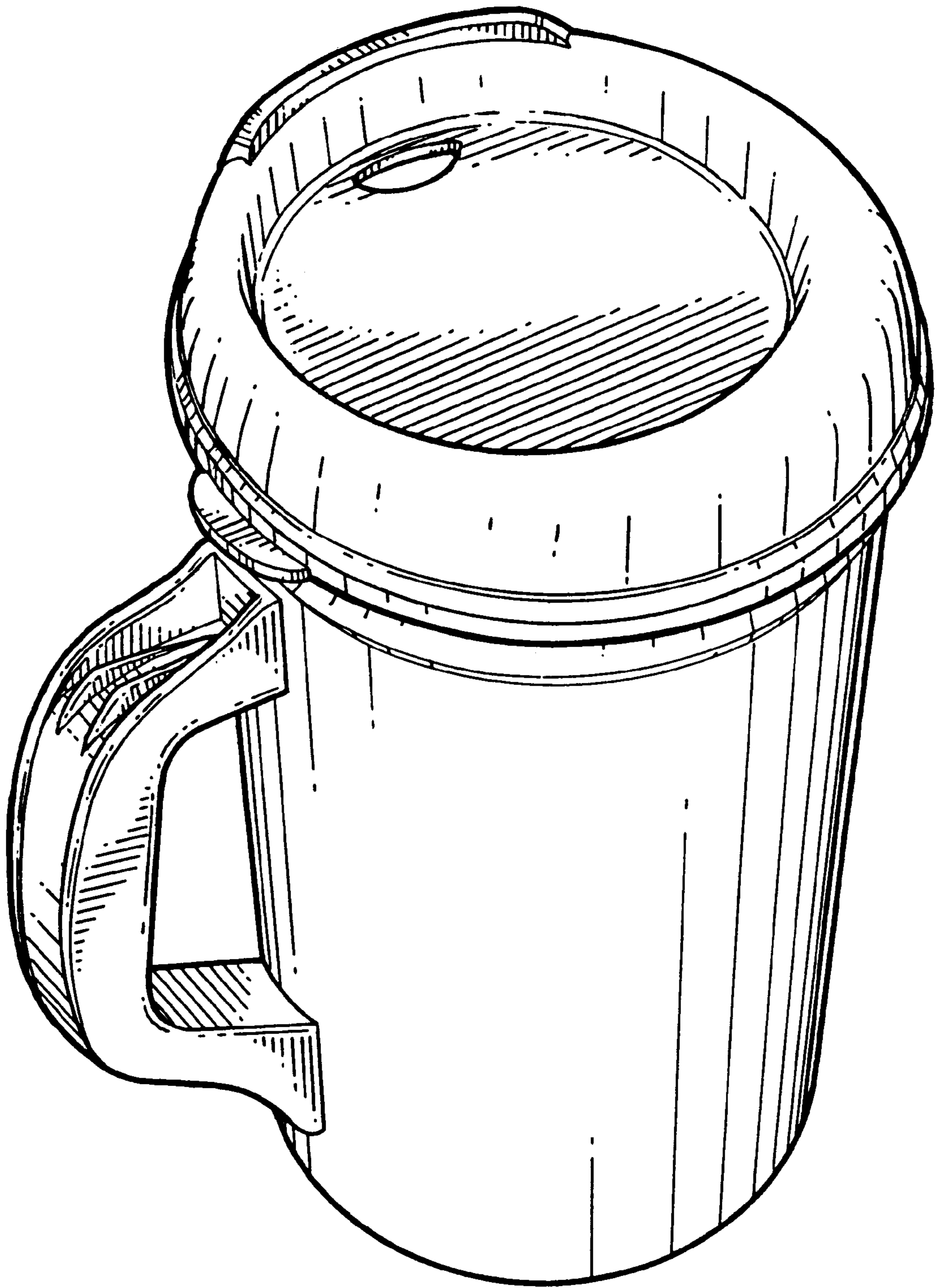

FIG. 11