



US00D411692S

United States Patent [19] Ogg

[11] **Patent Number: Des. 411,692**

[45] **Date of Patent: ** Jun. 29, 1999**

[54] **CHAIR**

[75] Inventor: **Richard K. Ogg**, Littlestown, Pa.

[73] Assignee: **HON Technology Inc.**, Muscatine, Iowa

[**] Term: **14 Years**

[21] Appl. No.: **29/061,346**

[22] Filed: **Oct. 22, 1996**

[51] **LOC (6) Cl.** **06-01**

[52] **U.S. Cl.** **D6/366**

[58] **Field of Search** D6/334, 364, 365,
D6/366, 367, 375, 380, 500, 501, 502;
297/411.36

[56] **References Cited**

U.S. PATENT DOCUMENTS

- D. 185,849 8/1959 Christenson et al. .
- D. 197,643 3/1964 Kramer .
- D. 233,808 12/1974 Ruf .
- D. 236,173 8/1975 Ruf .
- D. 255,293 6/1980 Locher .

- D. 274,484 7/1984 Aronowitz et al. .
- D. 312,003 11/1990 Muller-Deisig et al. D6/366
- D. 312,536 12/1990 Muller-Deisig et al. .
- D. 322,363 12/1991 Narita D6/366
- D. 346,909 5/1994 Obata et al. D6/366
- D. 353,718 12/1994 Olson D6/366
- D. 377,424 1/1997 Olson D6/366
- 3,774,960 11/1973 Blodee D6/380 X

Primary Examiner—Gary D. Watson
Attorney, Agent, or Firm—Jones, Day, Reavis & Pogue

[57] **CLAIM**

The ornamental design for a chair, as shown.

DESCRIPTION

FIG. 1 is a right side perspective view of a chair showing my new design;
FIG. 2 is a left side view thereof;
FIG. 3 is a right side view thereof;
FIG. 4 is a front view thereof;
FIG. 5 is a rear view thereof;
FIG. 6 is a top view thereof; and,
FIG. 7 is a bottom view thereof.

1 Claim, 4 Drawing Sheets

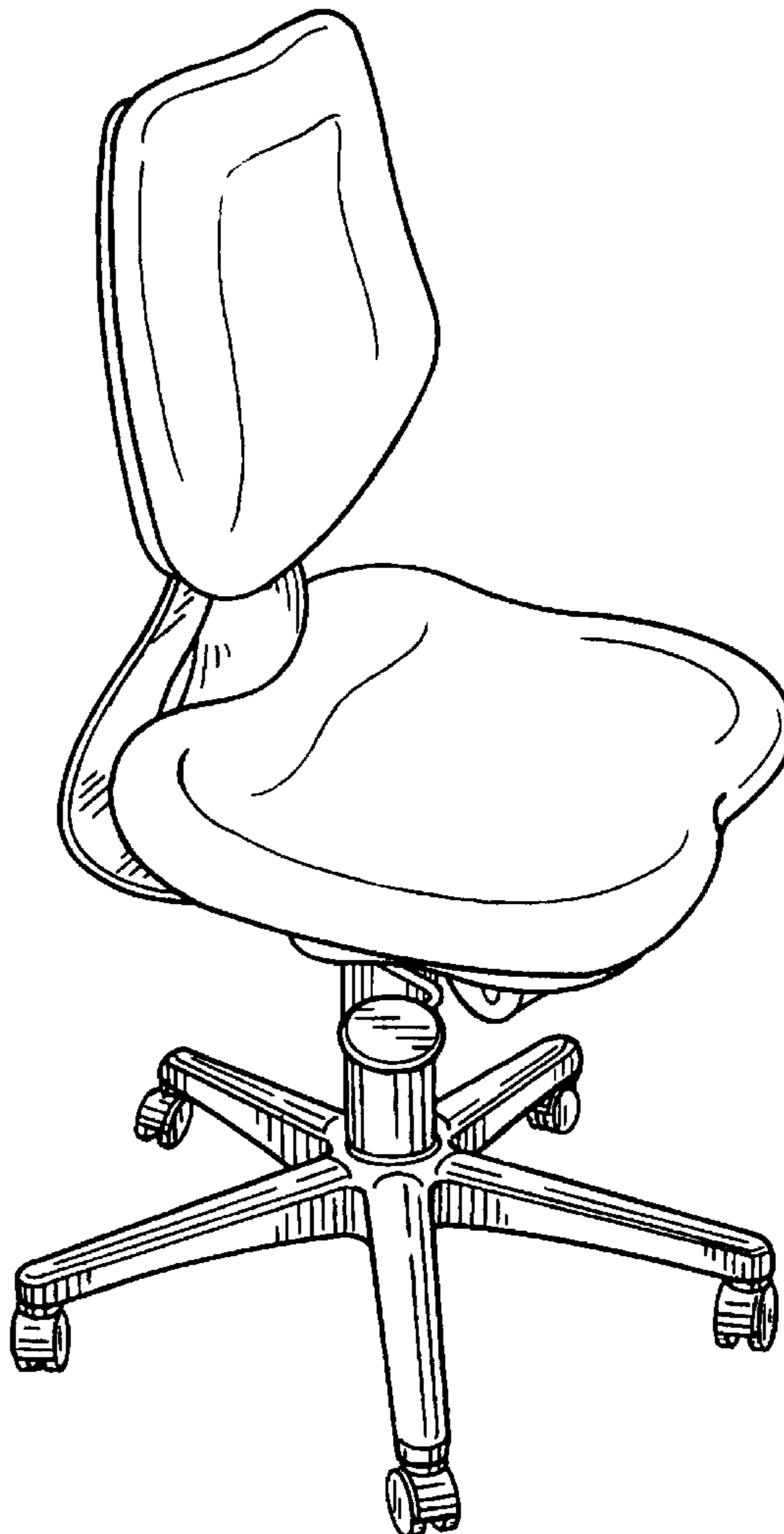

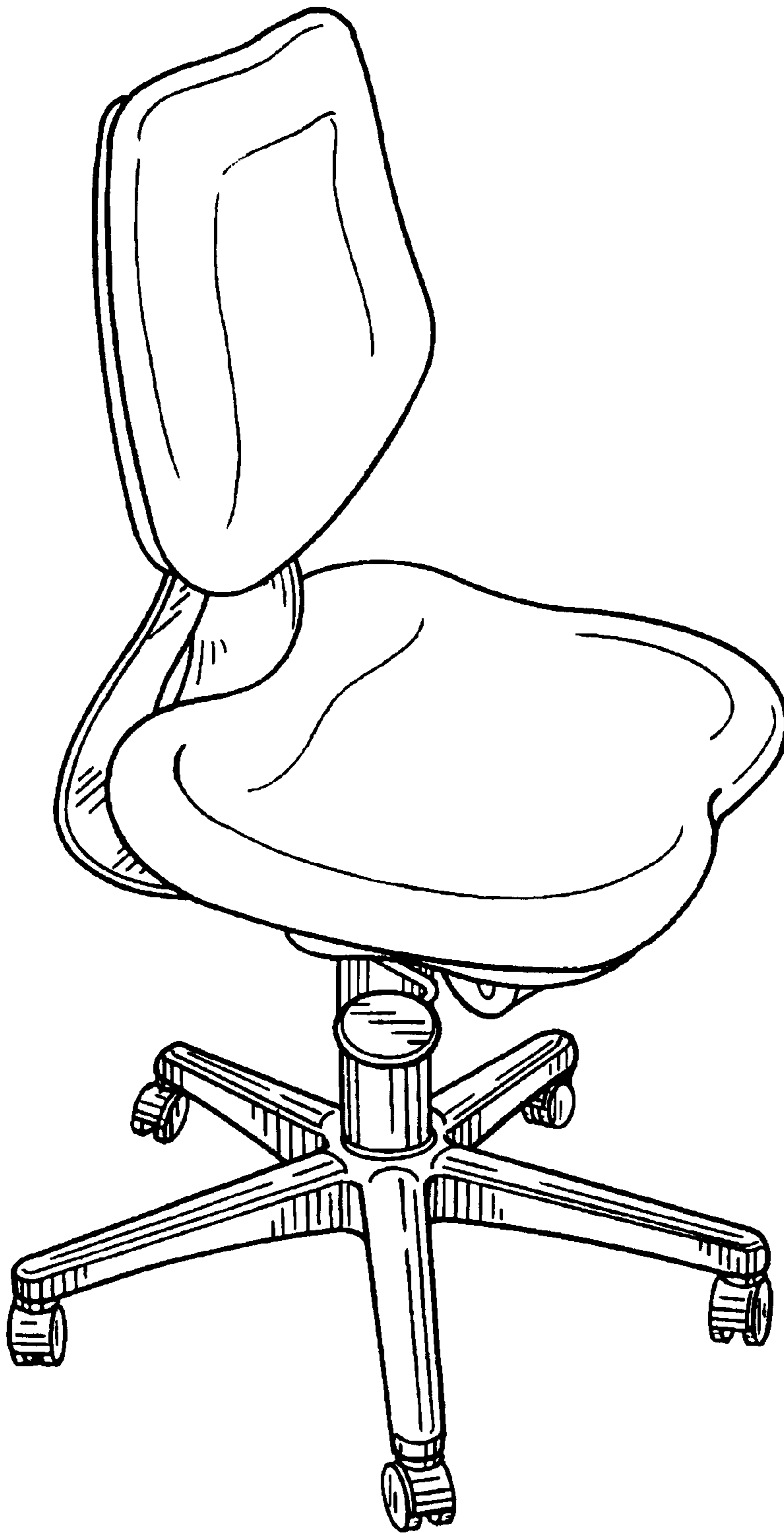

FIG. 1

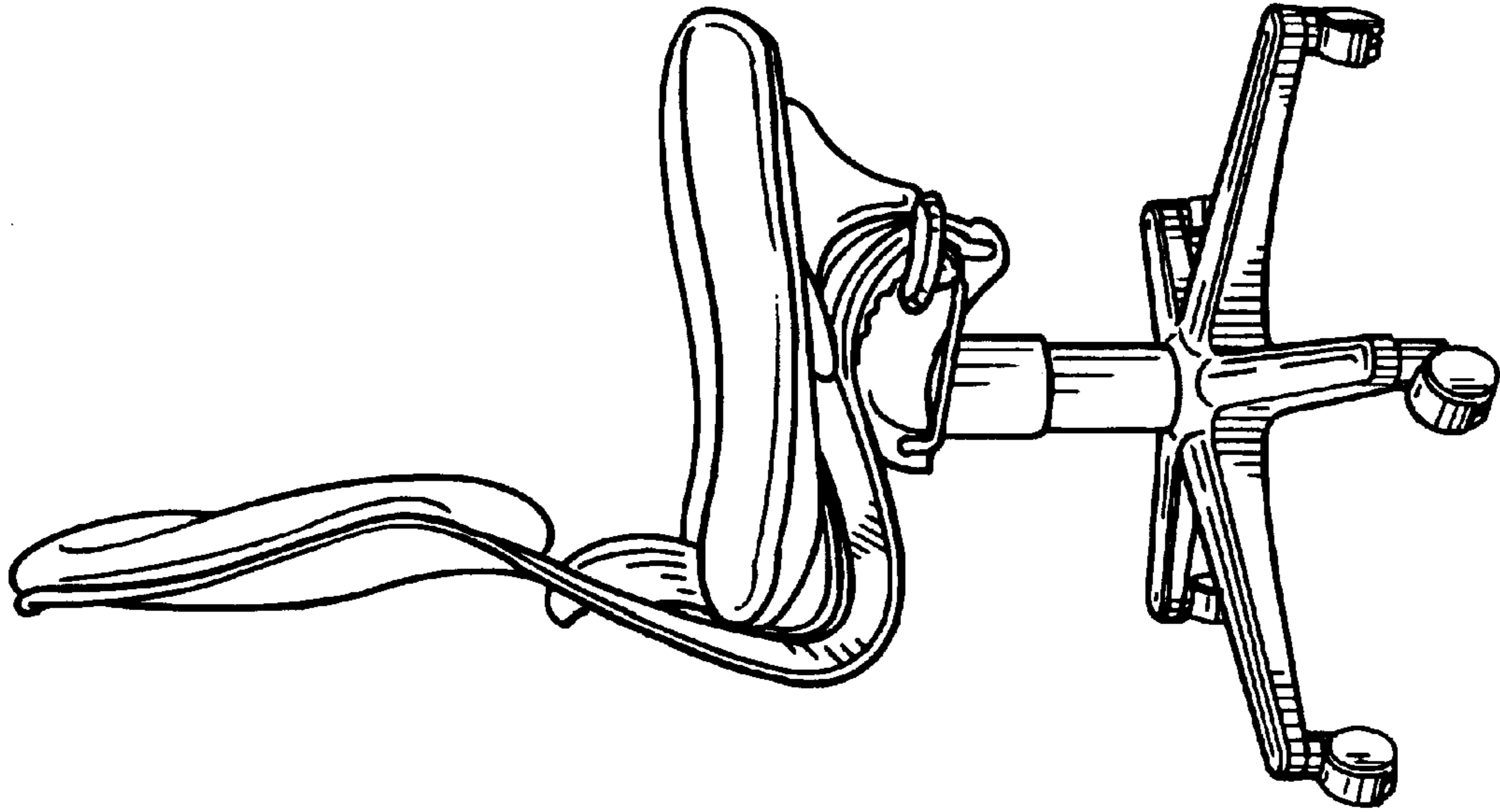

FIG. 3

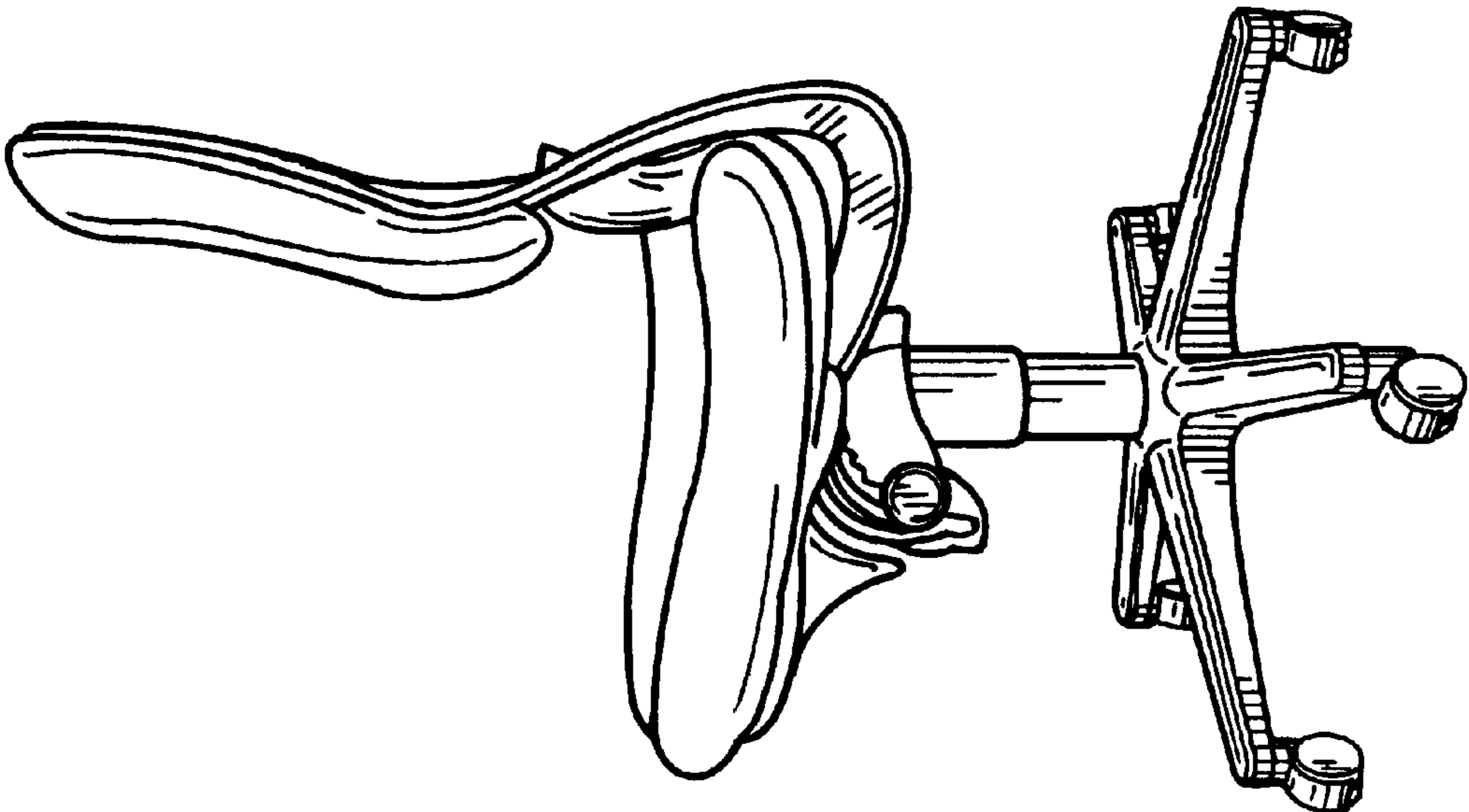

FIG. 2

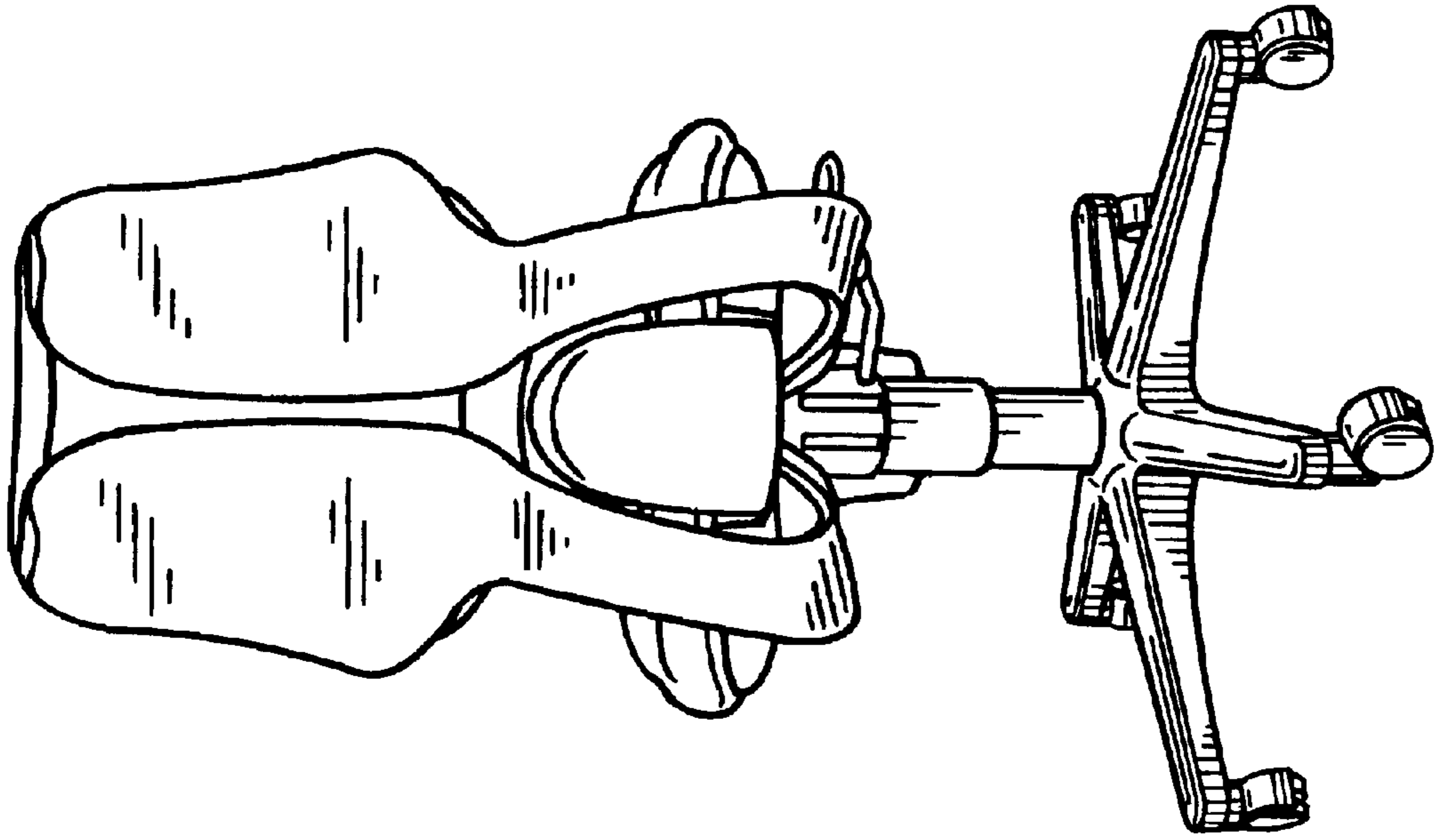

FIG. 5

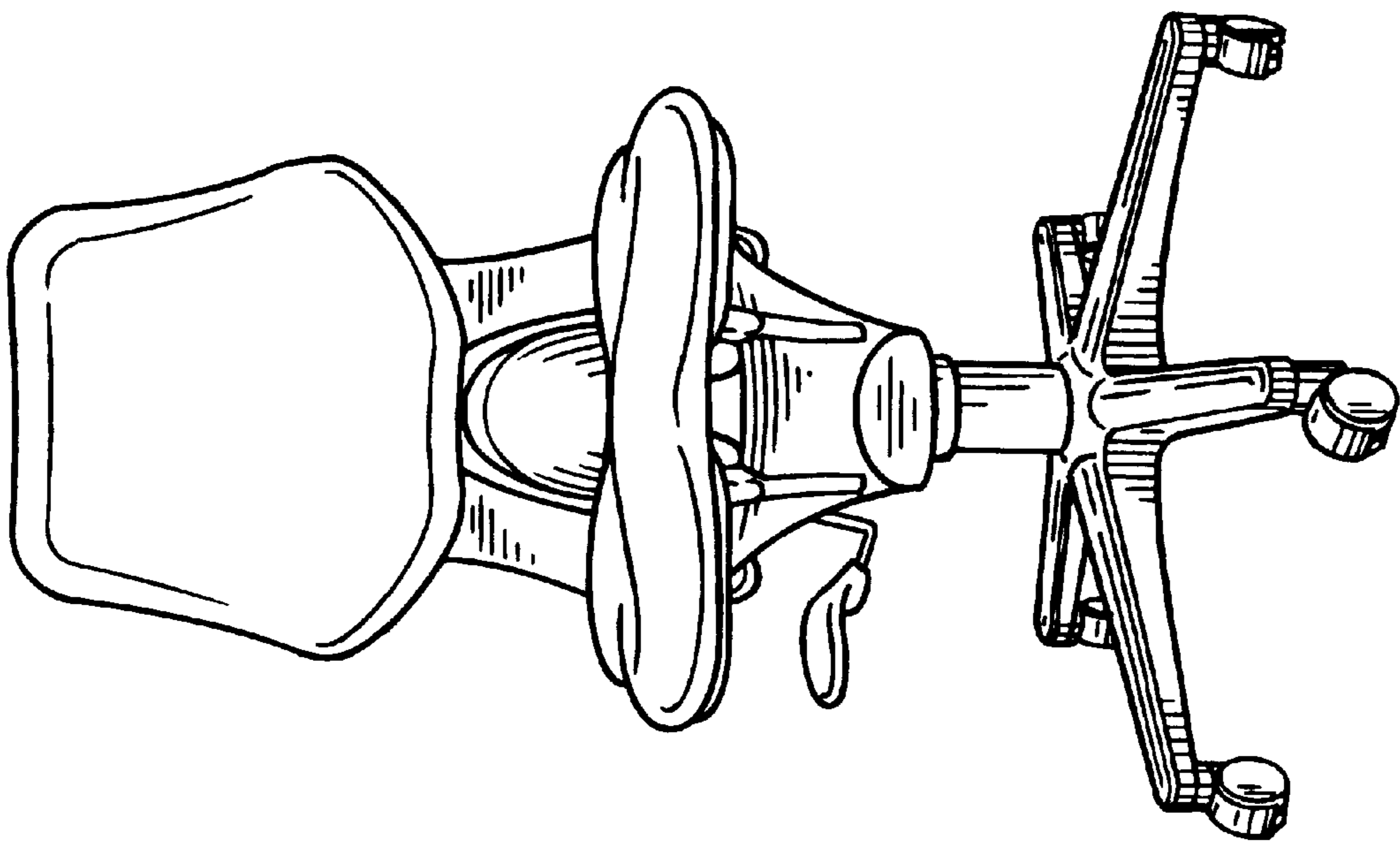

FIG. 4

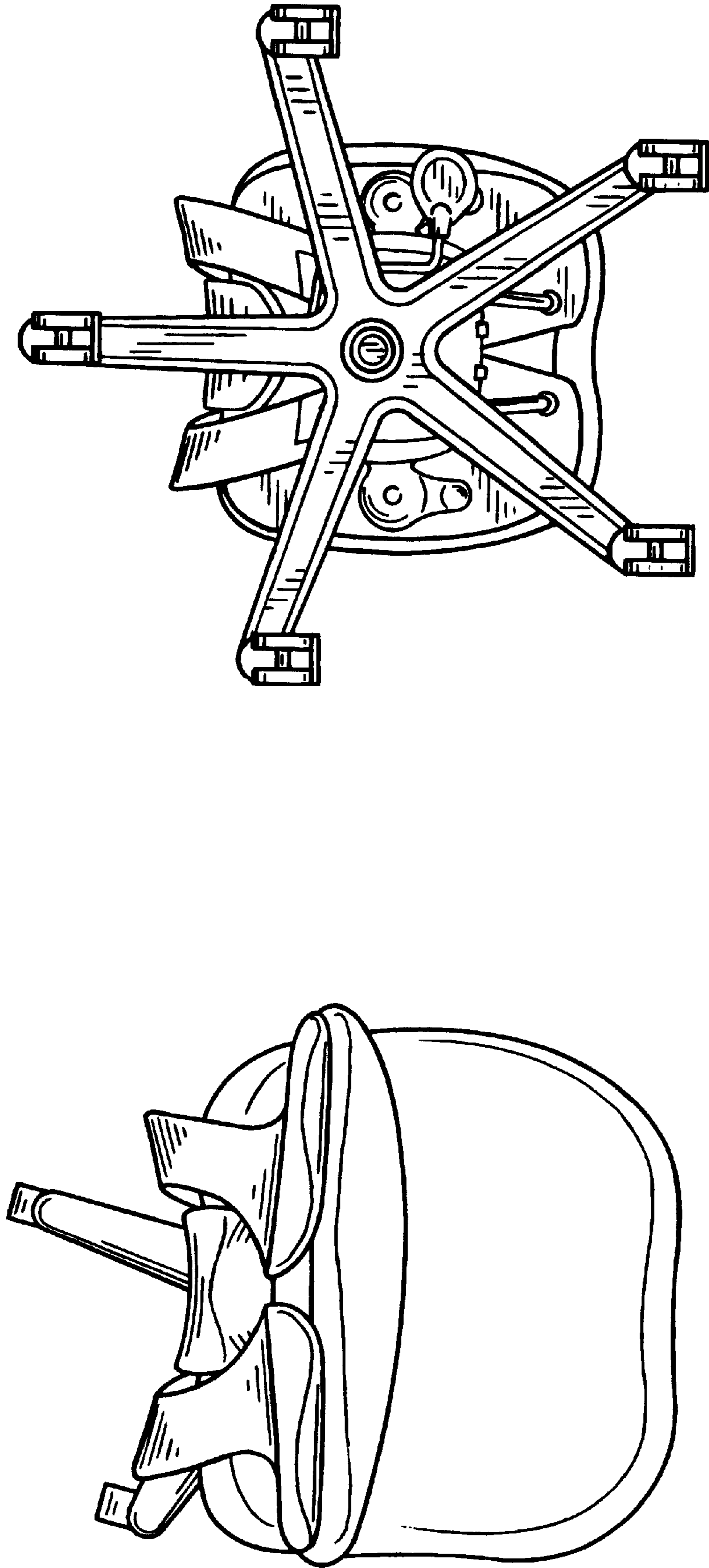

FIG. 6

FIG. 7