



US00D411663S

United States Patent [19] Dolmatsky

[11] **Patent Number: Des. 411,663**
[45] **Date of Patent: ** Jun. 29, 1999**

[54] **GRIPPER PORTFOLIO**

[75] Inventor: **Alex Dolmatsky**, Studio City, Calif.

[73] Assignee: **Leather Craft Technology, Inc.**, Sun Valley, Calif.

[**] Term: **14 Years**

[21] Appl. No.: **29/091,722**

[22] Filed: **Aug. 4, 1998**

[51] **LOC (6) Cl.** **03-01**

[52] **U.S. Cl.** **D3/303; D3/900; D19/26**

[58] **Field of Search** **D3/303, 299, 900; D19/26, 75, 86; 190/100, 901, 900, 111; 206/215, 278**

[56] **References Cited**

U.S. PATENT DOCUMENTS

D. 274,065	5/1984	Goutchat	D19/78
D. 302,699	8/1989	Popat et al.	D19/26
D. 304,343	10/1989	Popat et al.	D19/26
D. 314,587	2/1991	Young	D3/900
D. 316,180	4/1991	Hines	D3/900
D. 319,729	9/1991	Kogutt	D3/900
D. 337,610	7/1993	Mixon	D19/26
D. 359,507	6/1995	Schmidt	D19/26

D. 363,603	10/1995	Leveen et al.	D3/303
D. 383,790	9/1997	Leveen et al.	D19/88
D. 398,778	9/1998	Wyant	D3/303
1,482,659	2/1924	Oswald	.	
2,080,591	5/1937	Wright	.	
4,420,112	12/1983	Cline	229/72
4,739,541	4/1988	Pitts	24/67.7

Primary Examiner—Philip S. Hyder
Attorney, Agent, or Firm—Norton R. Townsley

[57] **CLAIM**

I claim the ornamental design for a gripper portfolio, as shown and described.

DESCRIPTION

FIG. 1 is a front, perspective view of a gripper portfolio showing my new design;
FIG. 2 is a top, plan view thereof;
FIG. 3 is a bottom, plan view thereof;
FIG. 4 is a right side, elevational view thereof;
FIG. 5 is a left side, elevational view thereof;
FIG. 6 is front, elevational view thereof;
FIG. 7 is a rear, elevational view thereof; and,
FIG. 8 is a front, perspective view thereof with the flaps opened.

1 Claim, 5 Drawing Sheets

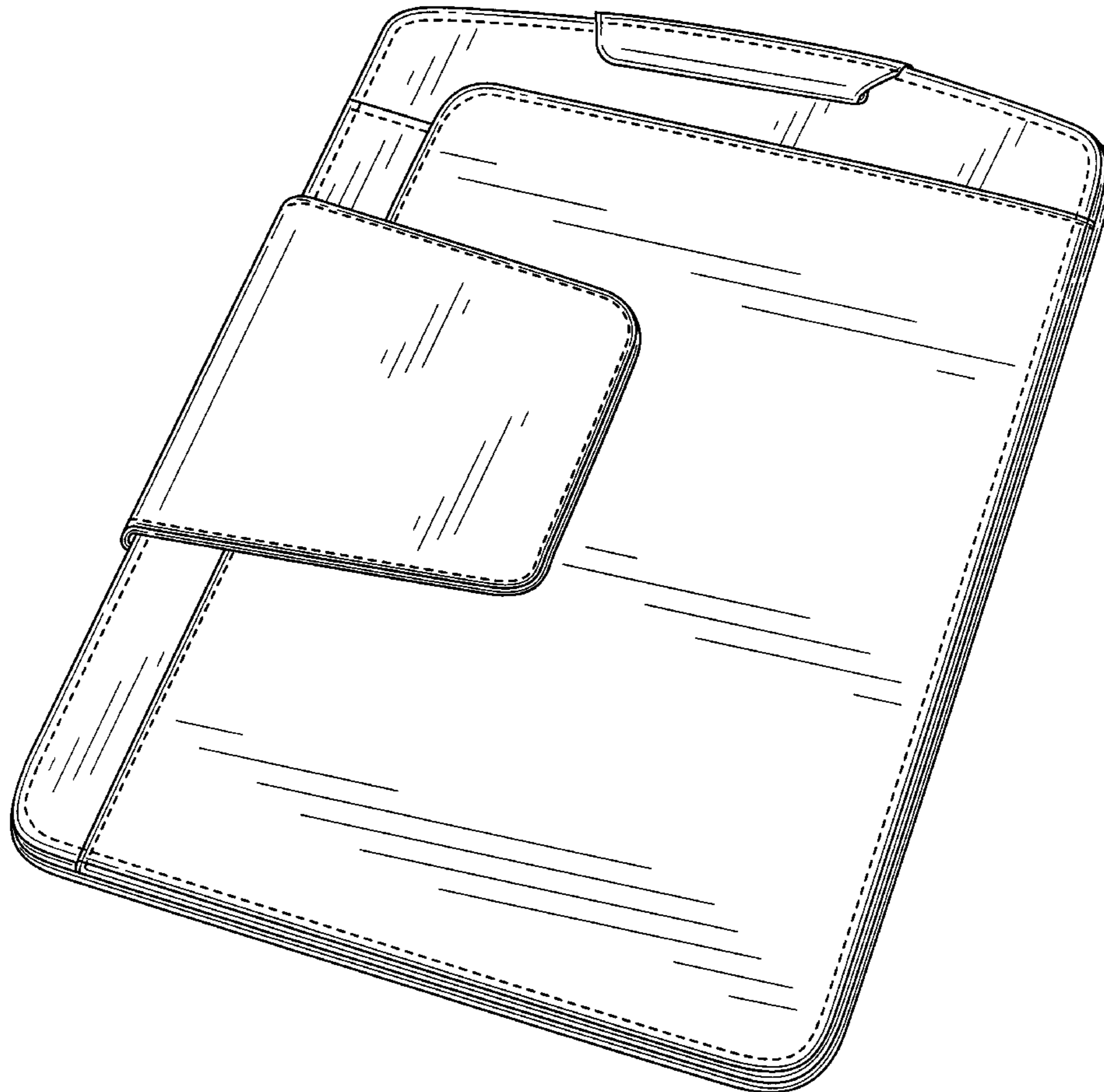

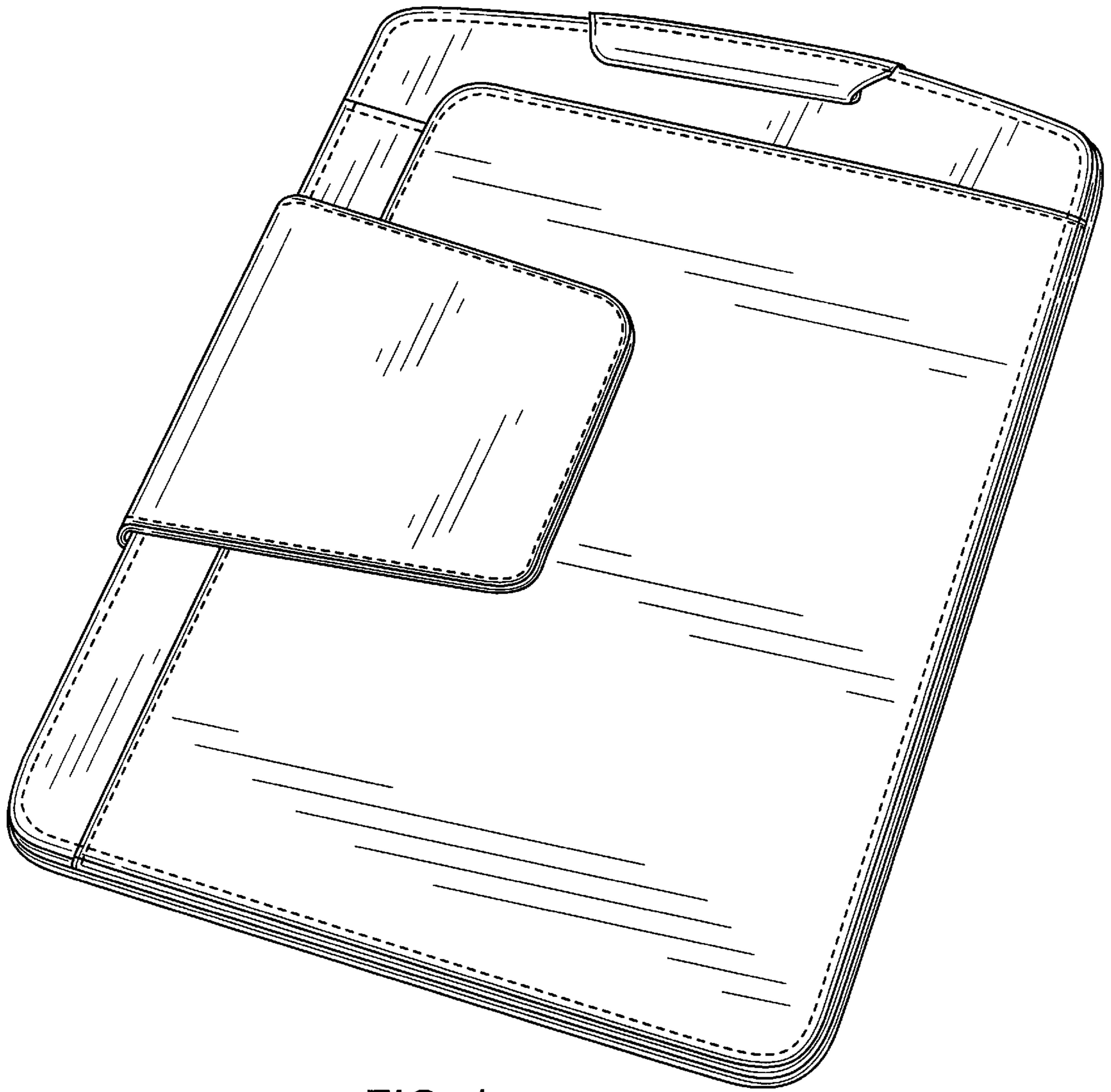

FIG. 1

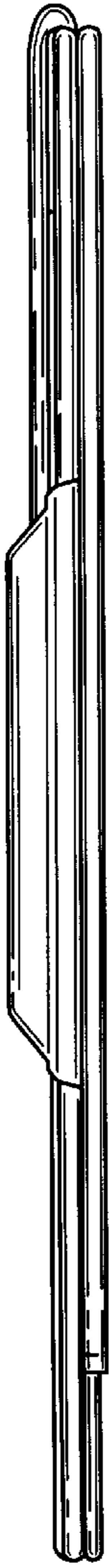

FIG. 2

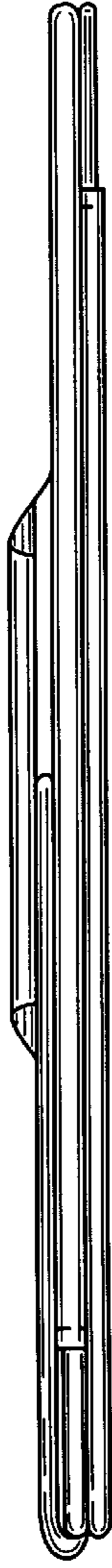

FIG. 3



FIG. 4

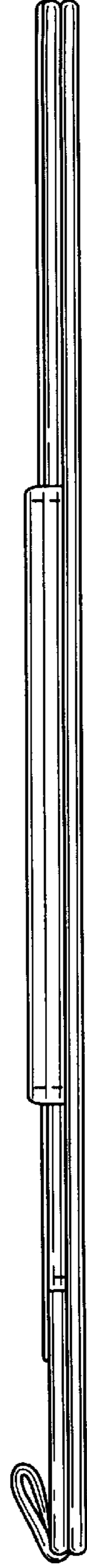

FIG. 5

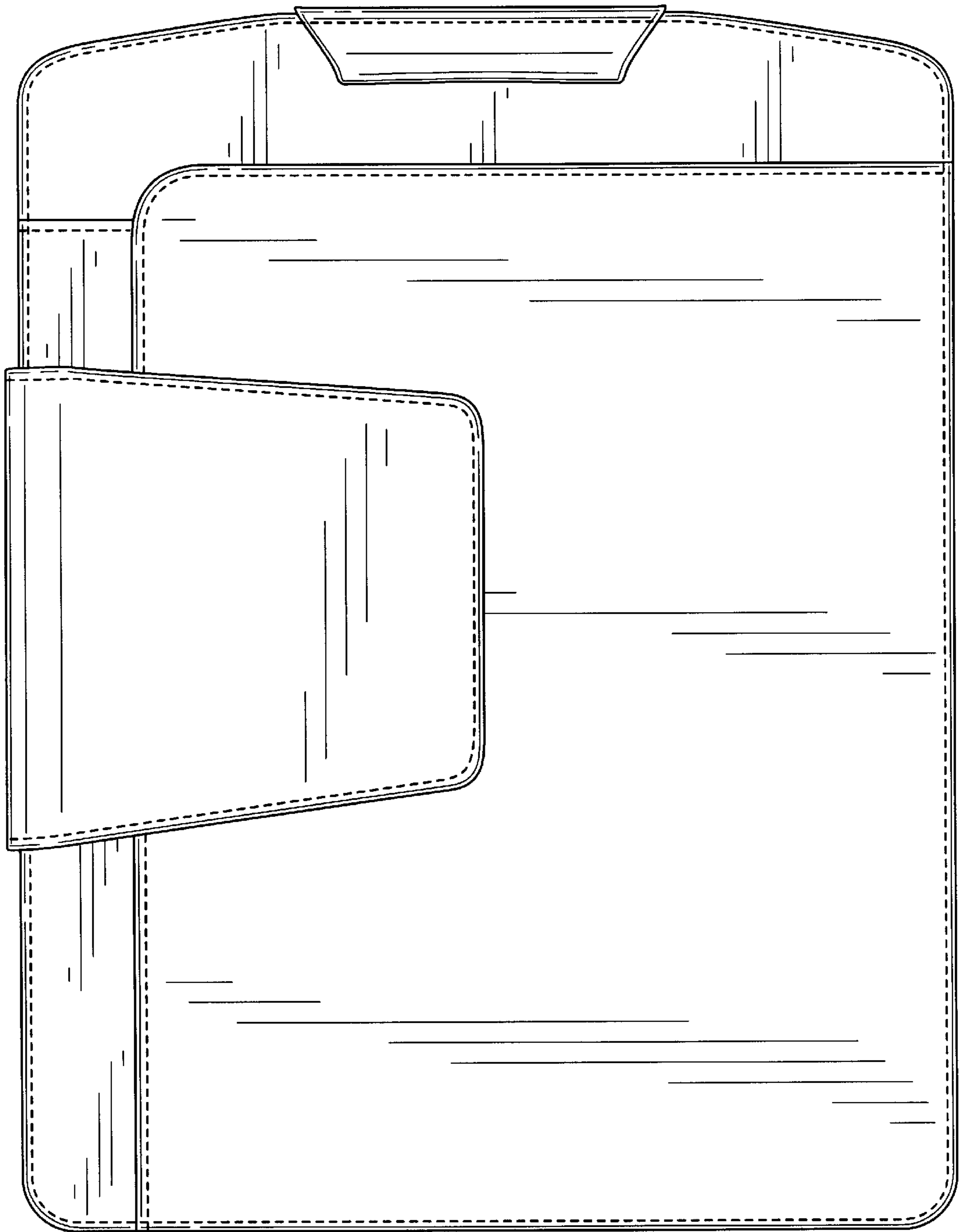

FIG. 6

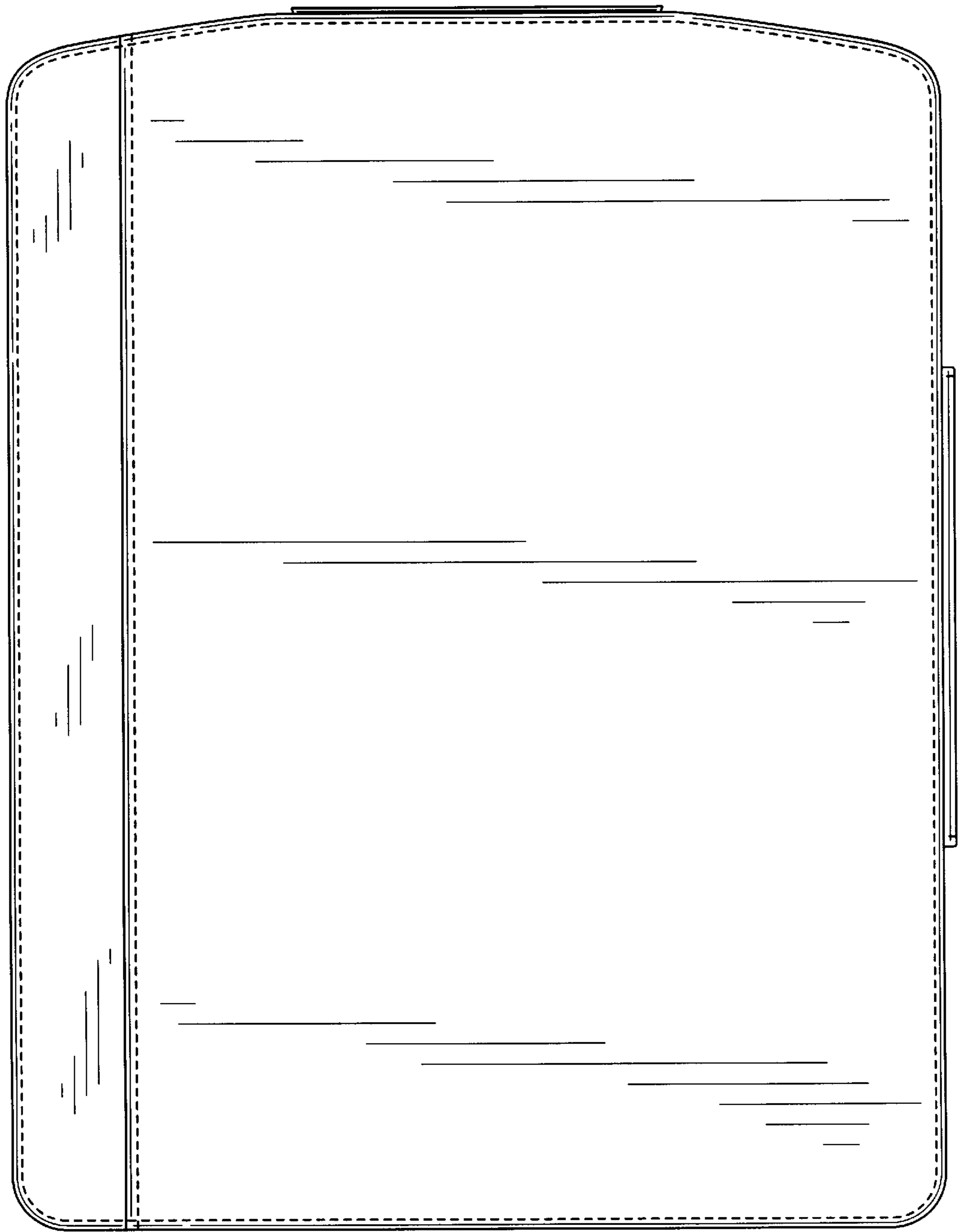

FIG. 7

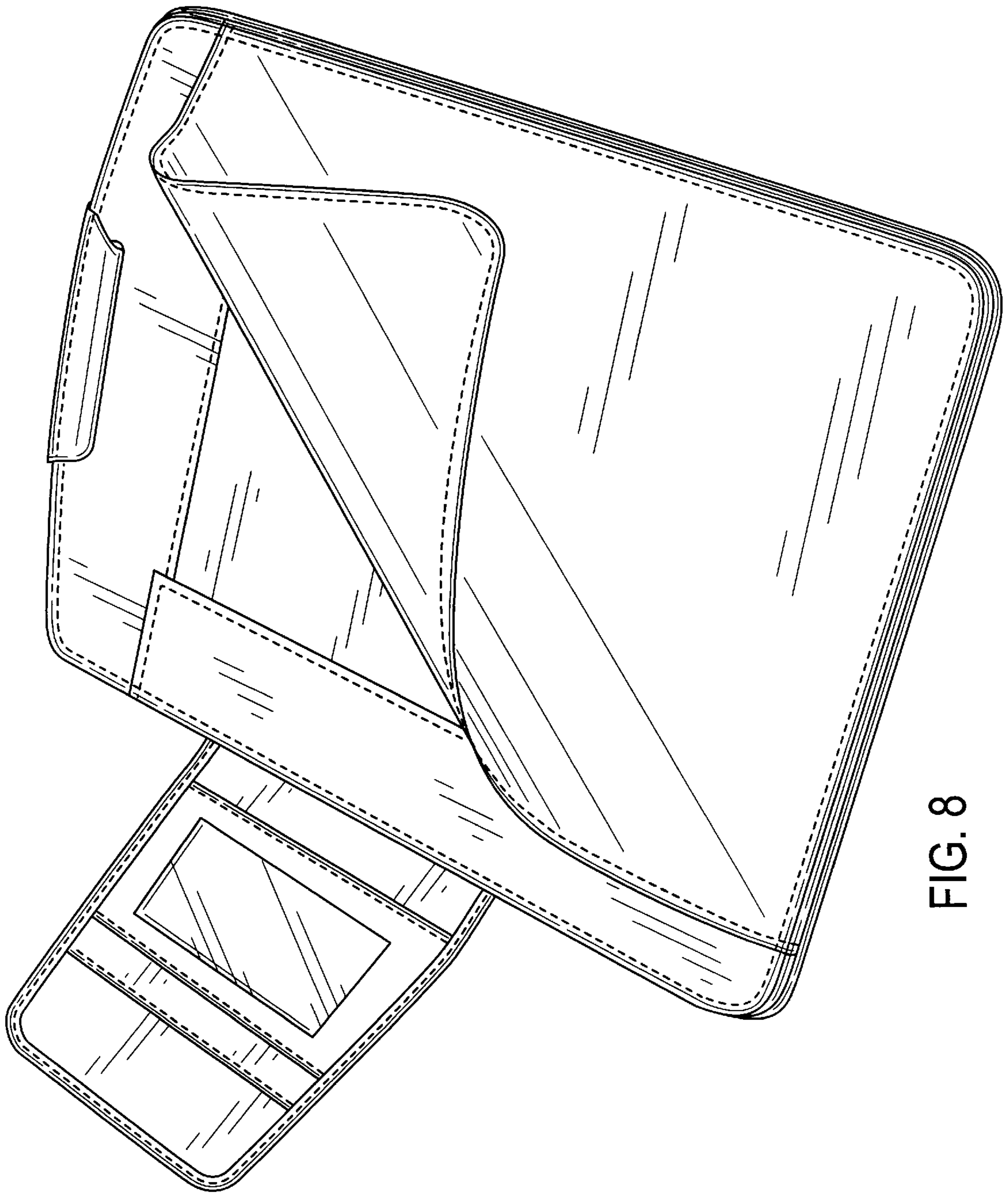

FIG. 8