



US00D411554S

**United States Patent** [19]  
**Lee**

[11] **Patent Number: Des. 411,554**

[45] **Date of Patent: \*\* Jun. 29, 1999**

[54] **HEAT SEALER**

[75] Inventor: **Tung-Lam Lee**, Shatin, The Hong Kong Special Administrative Region of the People's Republic of China

[73] Assignee: **Huge China Industrial Limited**, The Hong Kong Special Administrative Region of the People's Republic of China

[\*\*] Term: **14 Years**

[21] Appl. No.: **29/082,224**

[22] Filed: **Jan. 16, 1998**

[51] **LOC (6) Cl.** ..... **15-09**

[52] **U.S. Cl.** ..... **D15/146**

[58] **Field of Search** ..... D15/144, 144.1, D15/144.2, 146, 145; 53/373, 374.8, 374.9, 390, 405, 432-434, 510-512, DIG. 2; 156/497, 515, 583.1-583.91; 219/243, 230, 240

[56] **References Cited**

**U.S. PATENT DOCUMENTS**

D. 328,750 8/1992 Chou ..... D15/146

*Primary Examiner*—Antoine Duval Davis  
*Attorney, Agent, or Firm*—Burns, Doane, Swecker & Mathis, L.L.P.

[57] **CLAIM**

The ornamental design for a heat sealer, as shown and described.

**DESCRIPTION**

FIG. 1 is a front view of a heat sealer showing my design;  
FIG. 2 is a rear view thereof;  
FIG. 3 is a left side view thereof;  
FIG. 4 is a right side view thereof;  
FIG. 5 is a top view thereof;  
FIG. 6 is a bottom view thereof;  
FIG. 7 is a perspective view from front, above and one side thereof; and,  
FIG. 8 is a perspective view from above and one side thereof.

**1 Claim, 8 Drawing Sheets**

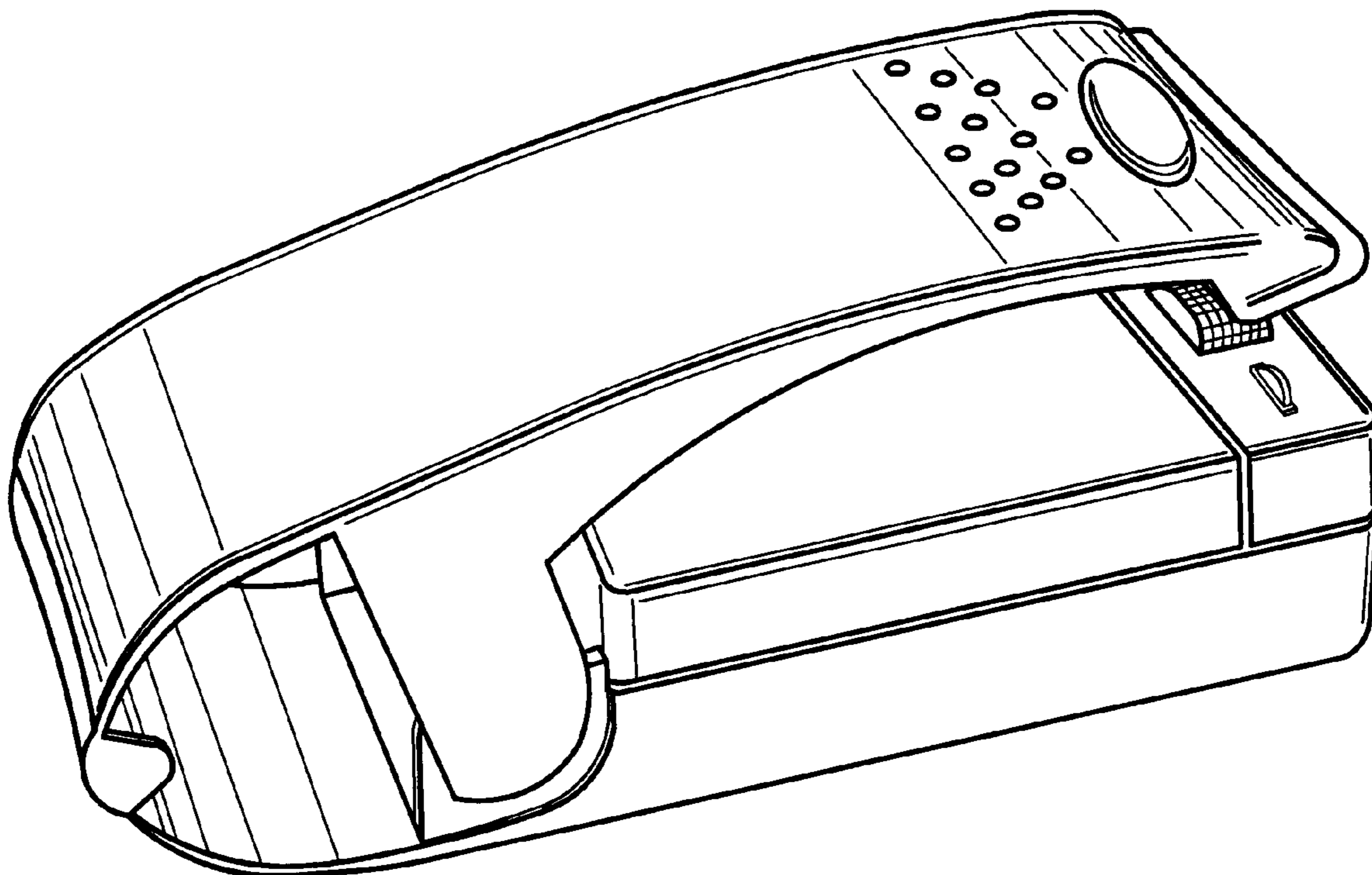

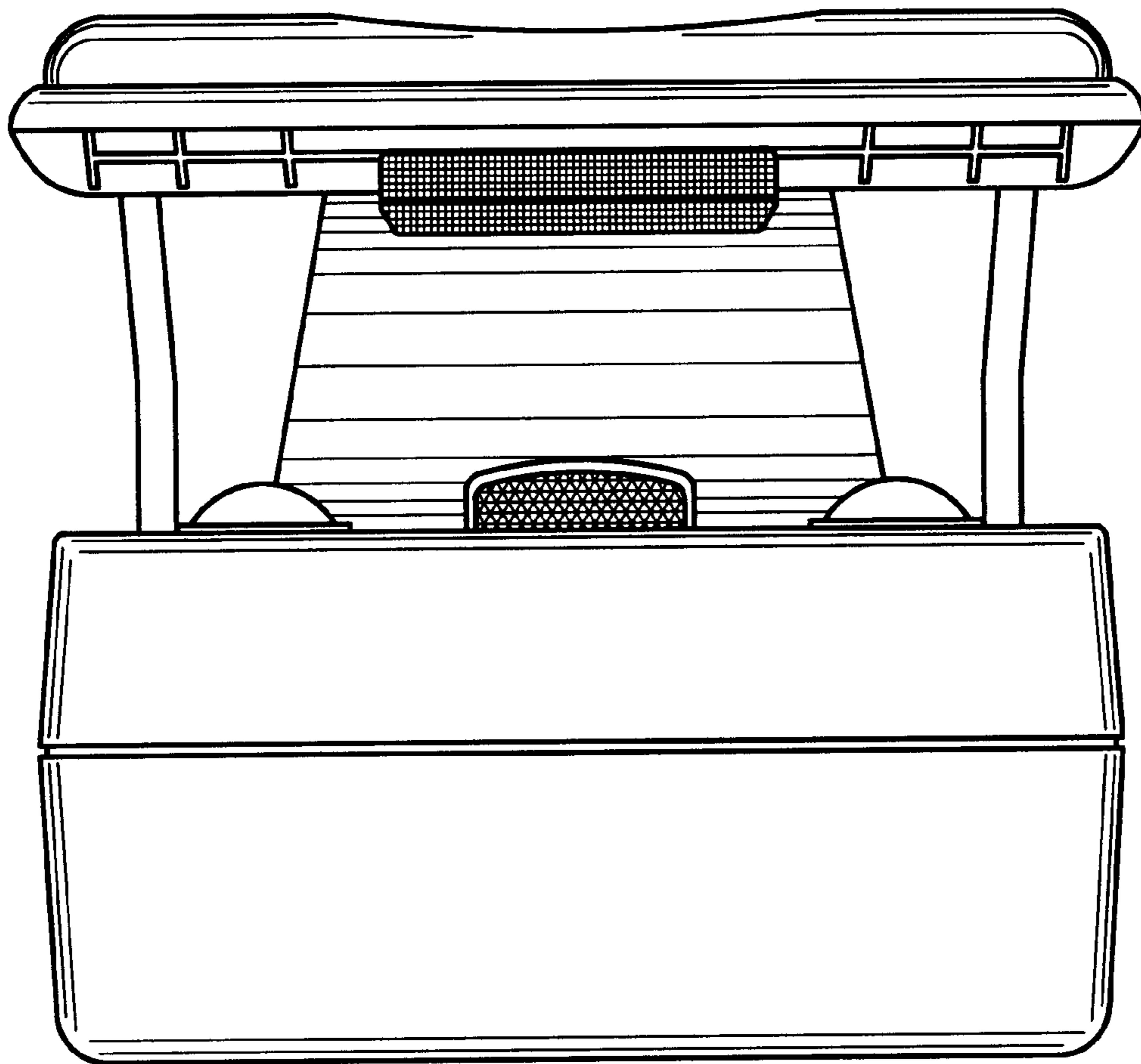

FIG. 1

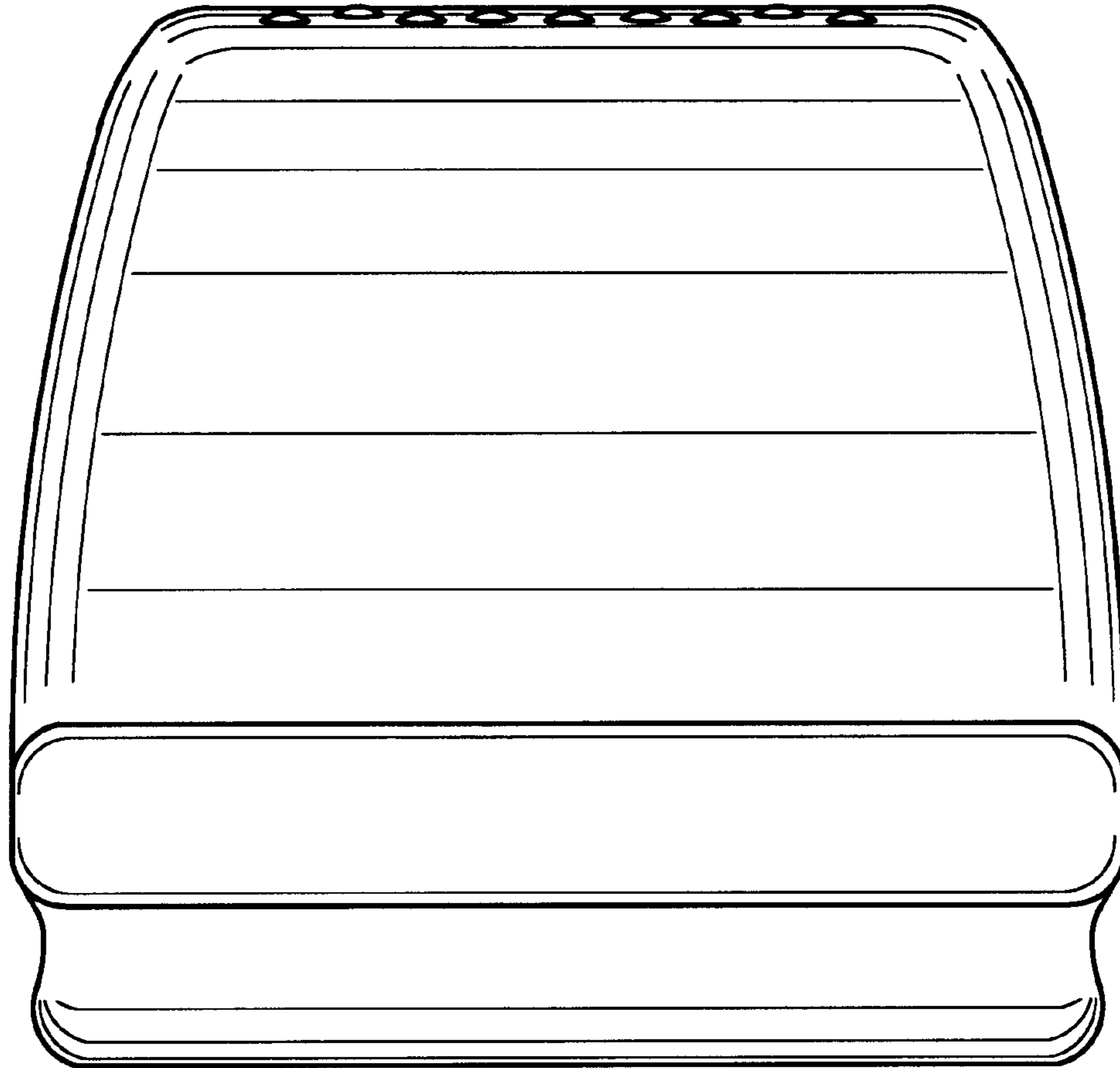

FIG.2

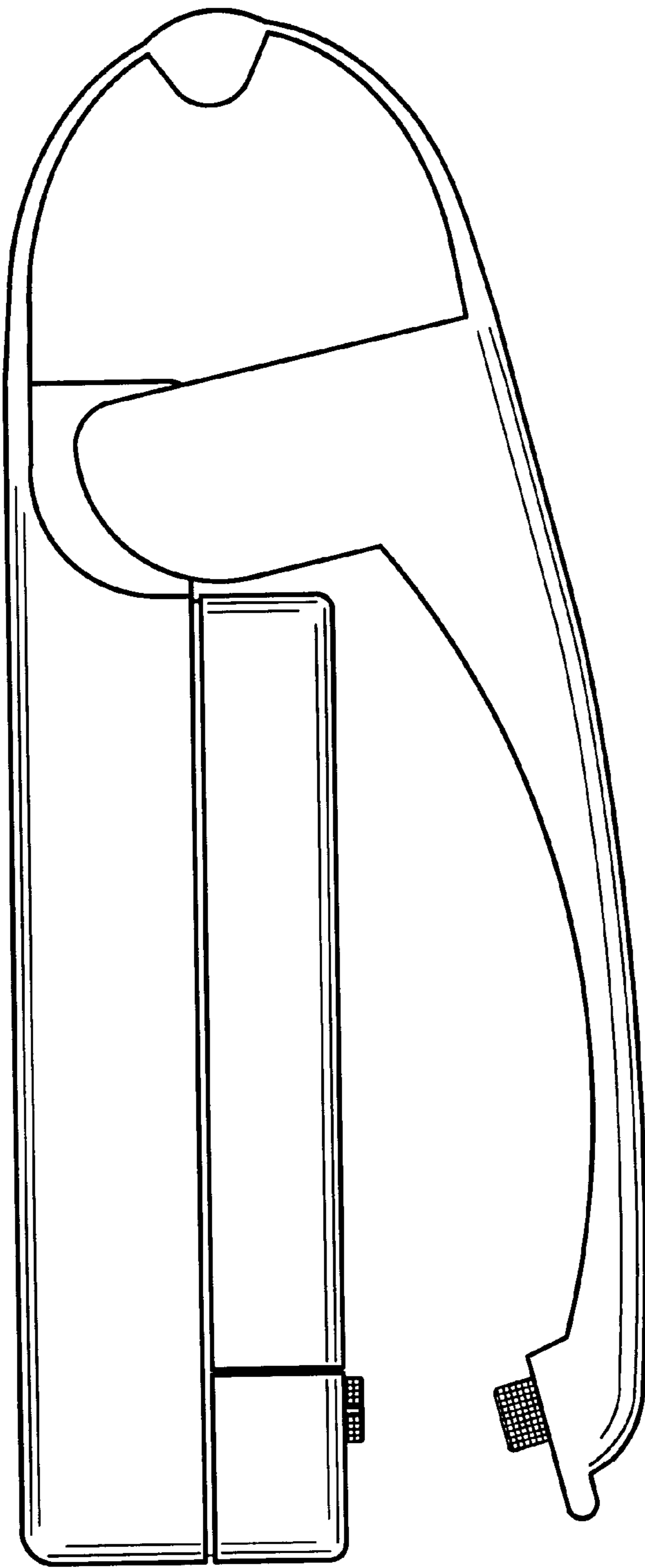

FIG. 3

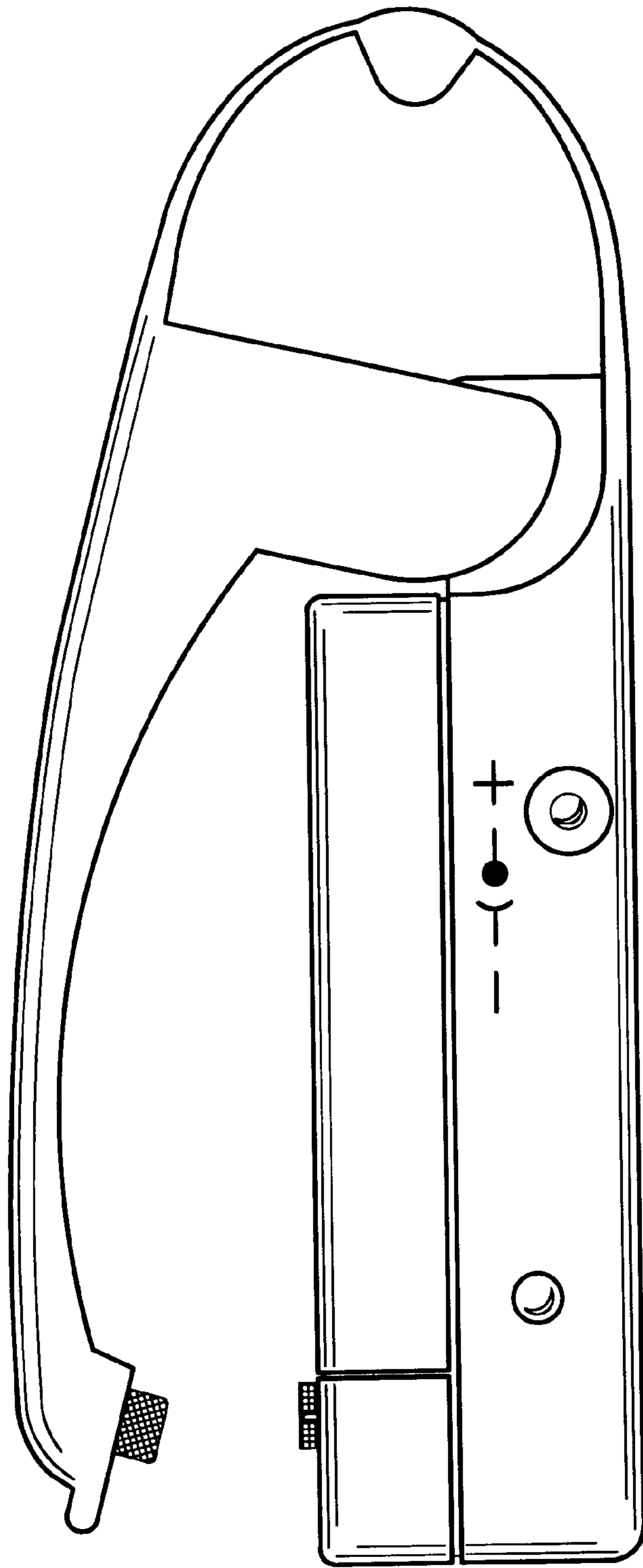

FIG.4

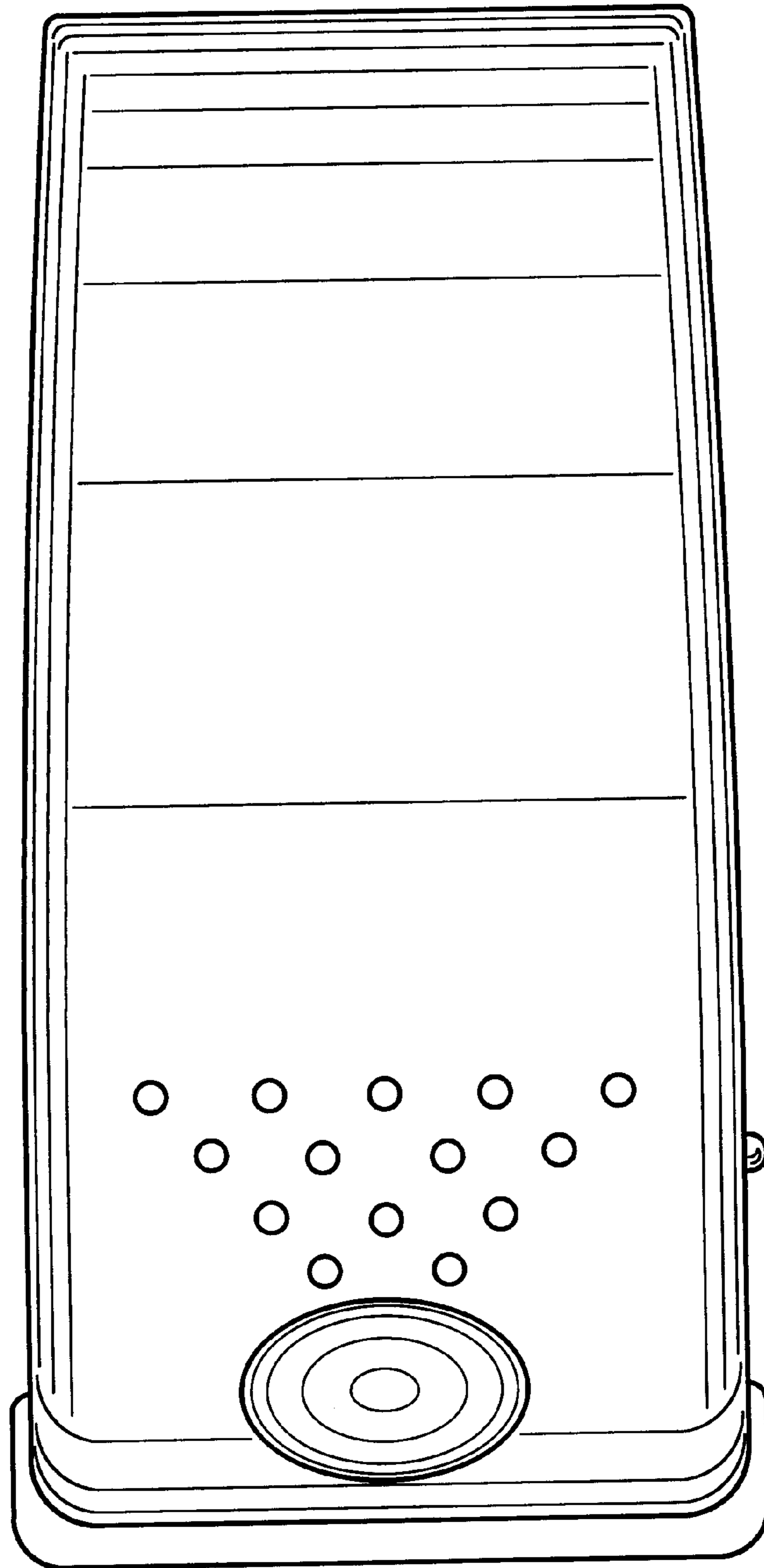

FIG. 5

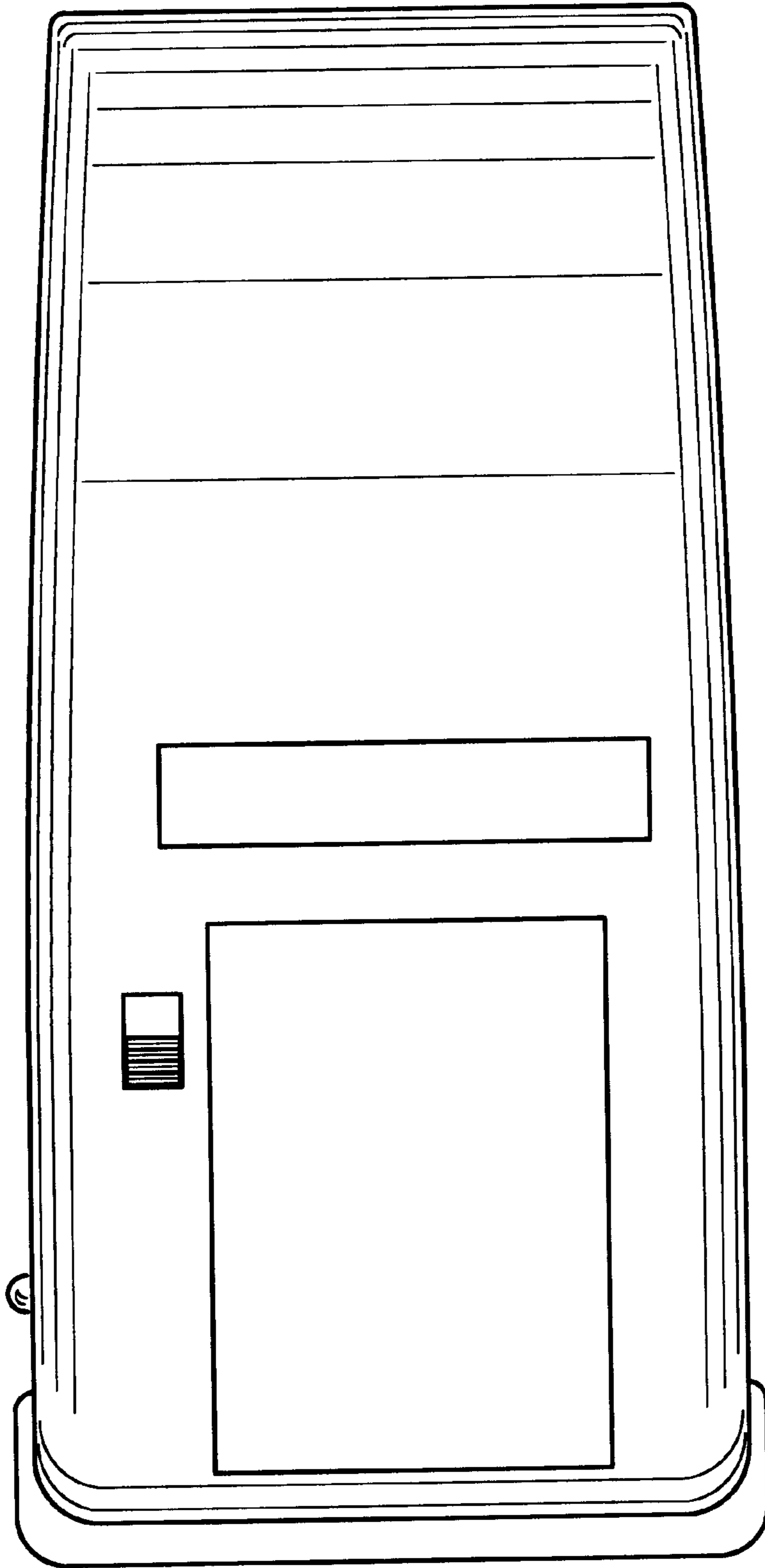

FIG.6

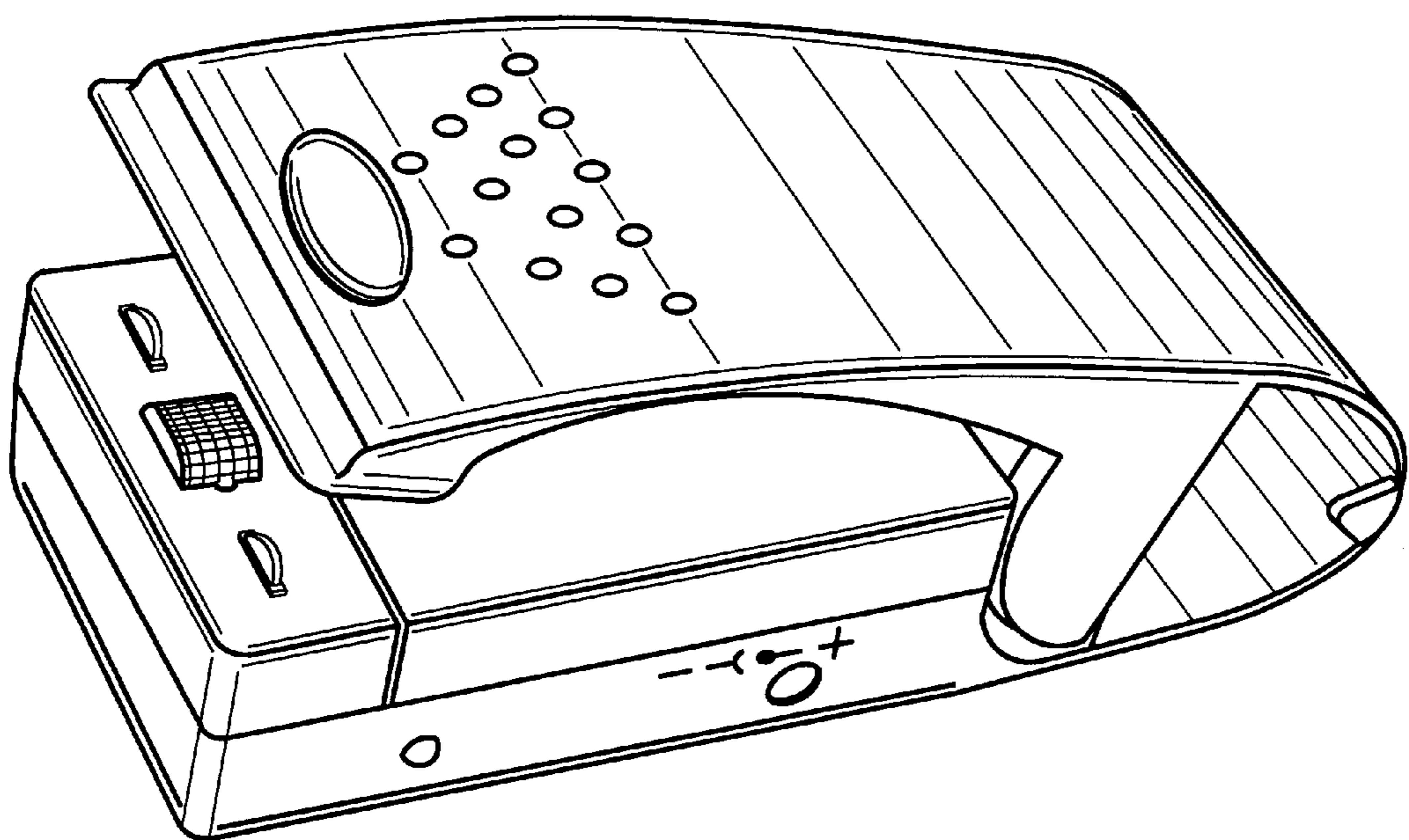

FIG.7



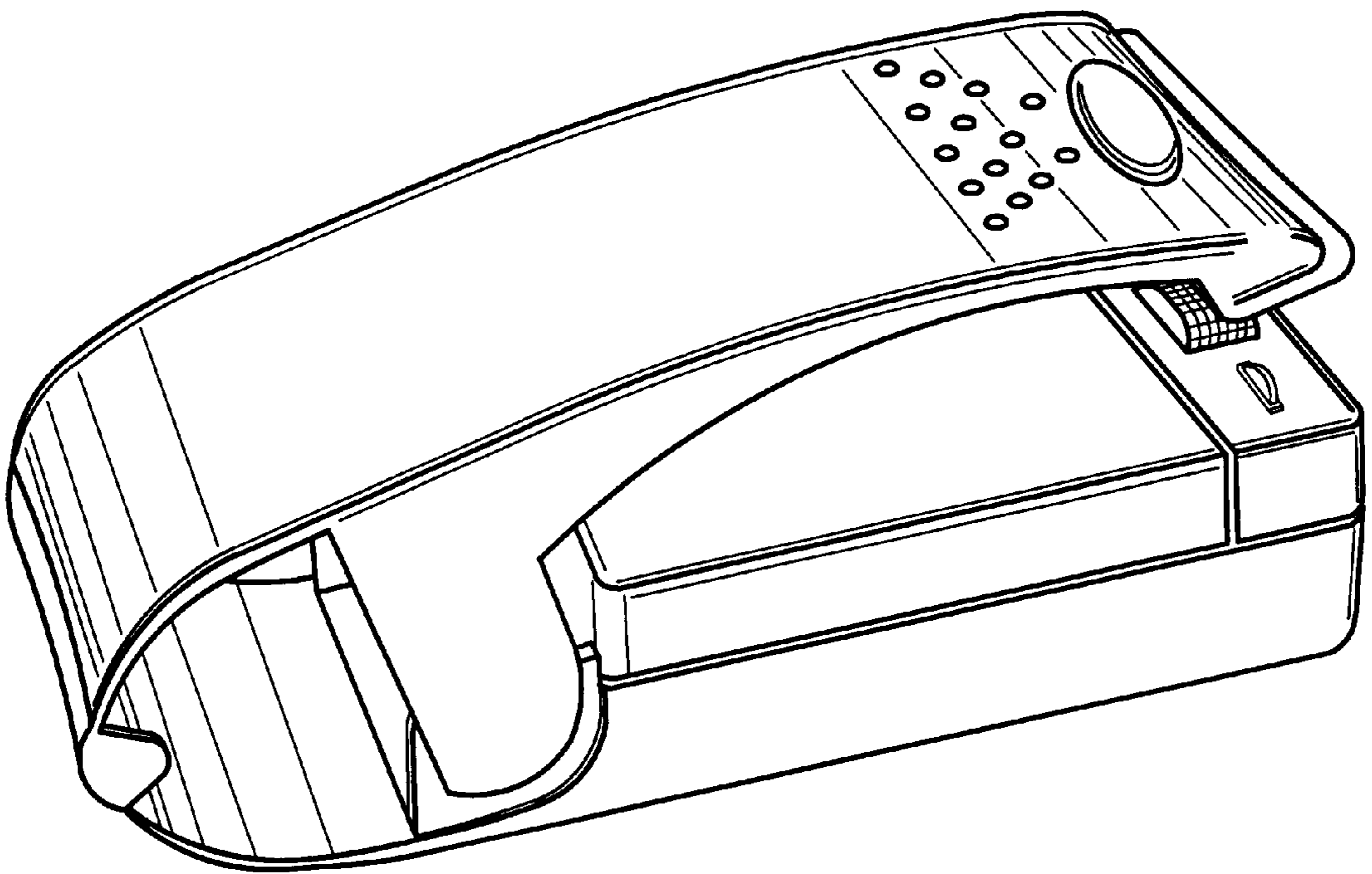

FIG. 8