



US00D411471S

**United States Patent** [19]  
**Fabian**

[11] **Patent Number: Des. 411,471**  
[45] **Date of Patent: \*\* Jun. 29, 1999**

[54] **KITCHEN SCALE**  
[75] Inventor: **Wolfgang Fabian**, Mannheim, Germany  
[73] Assignee: **Soehnle AG**, Montlingen, Switzerland  
[\*\*] Term: **14 Years**

[21] Appl. No.: **29/092,194**  
[22] Filed: **Aug. 13, 1998**

[30] **Foreign Application Priority Data**  
Feb. 13, 1998 [XH] Hague Agreement ..... DM/044104  
[51] **LOC (6) Cl.** ..... **10-04**  
[52] **U.S. Cl.** ..... **D10/91**  
[58] **Field of Search** ..... D10/91; 177/225-245,  
177/262

[56] **References Cited**  
**U.S. PATENT DOCUMENTS**  
D. 309,868 8/1990 Busse ..... D10/91  
D. 379,772 6/1997 Fabian ..... D10/91  
D. 395,612 6/1998 Fabian ..... D10/91

*Primary Examiner*—Antoine Duval Davis

*Attorney, Agent, or Firm*—Jones, Tullar & Cooper, P.C.

[57] **CLAIM**

The ornamental design for a kitchen scale, as shown and described.

**DESCRIPTION**

FIG. 1 is a top view of a kitchen scale showing my new design with an opaque tray;  
FIG. 2 is a bottom view thereof;  
FIG. 3 is a front elevational view thereof;  
FIG. 4 is a rear elevational view thereof;  
FIG. 5 is a left side elevational view thereof;  
FIG. 6 is a front left side perspective view thereof;  
FIG. 7 is a rear left side perspective view thereof;  
FIG. 8 is a top view of the kitchen scale showing my invention with an wooden tray;  
FIG. 9 is a bottom view thereof;  
FIG. 10 is a front elevational view thereof;  
FIG. 11 is a rear elevational view thereof;  
FIG. 12 is a left side elevational view thereof;  
FIG. 13 is a front left side perspective view thereof; and,  
FIG. 14 is a rear left side perspective view thereof.

**1 Claim, 4 Drawing Sheets**

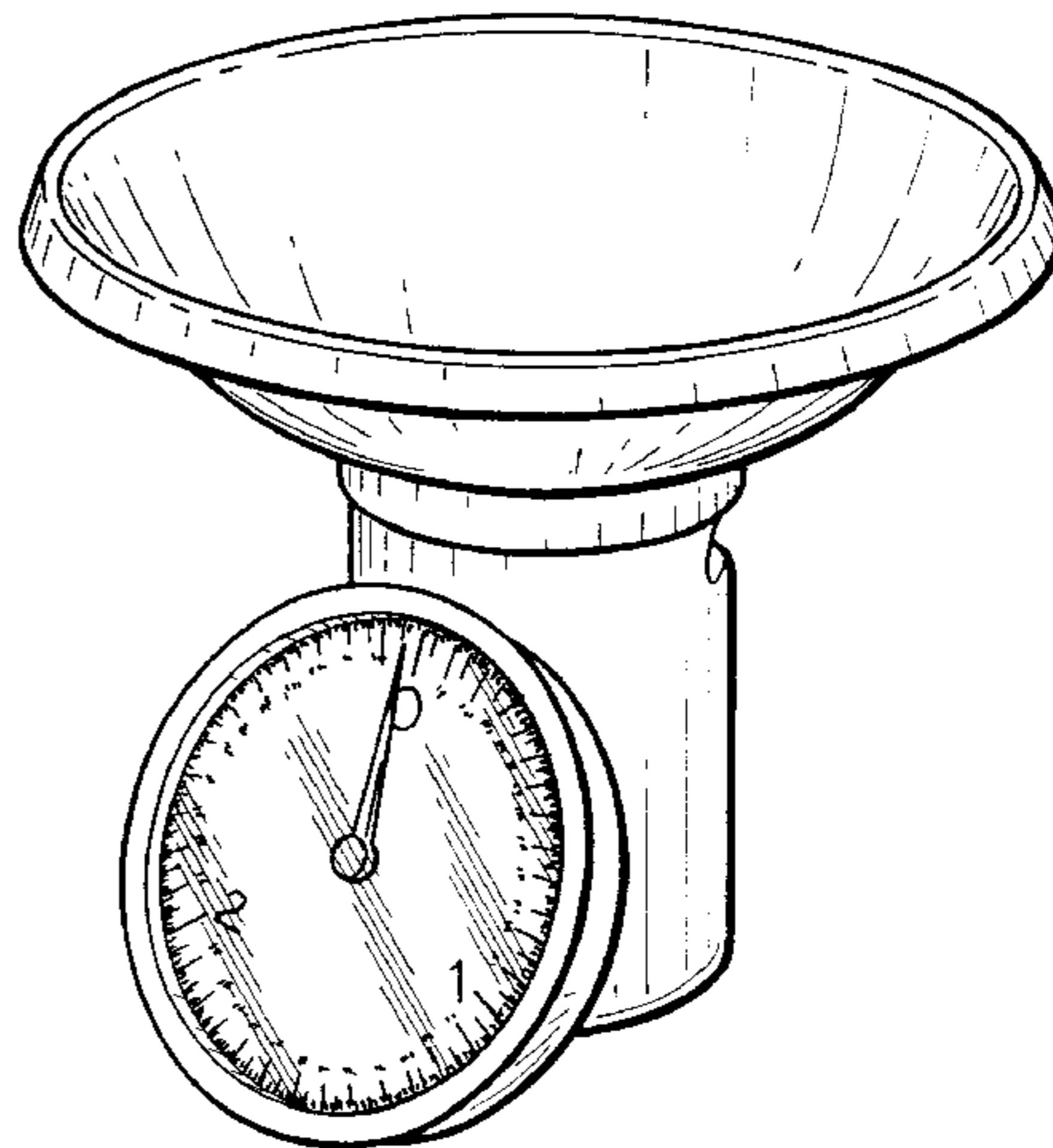
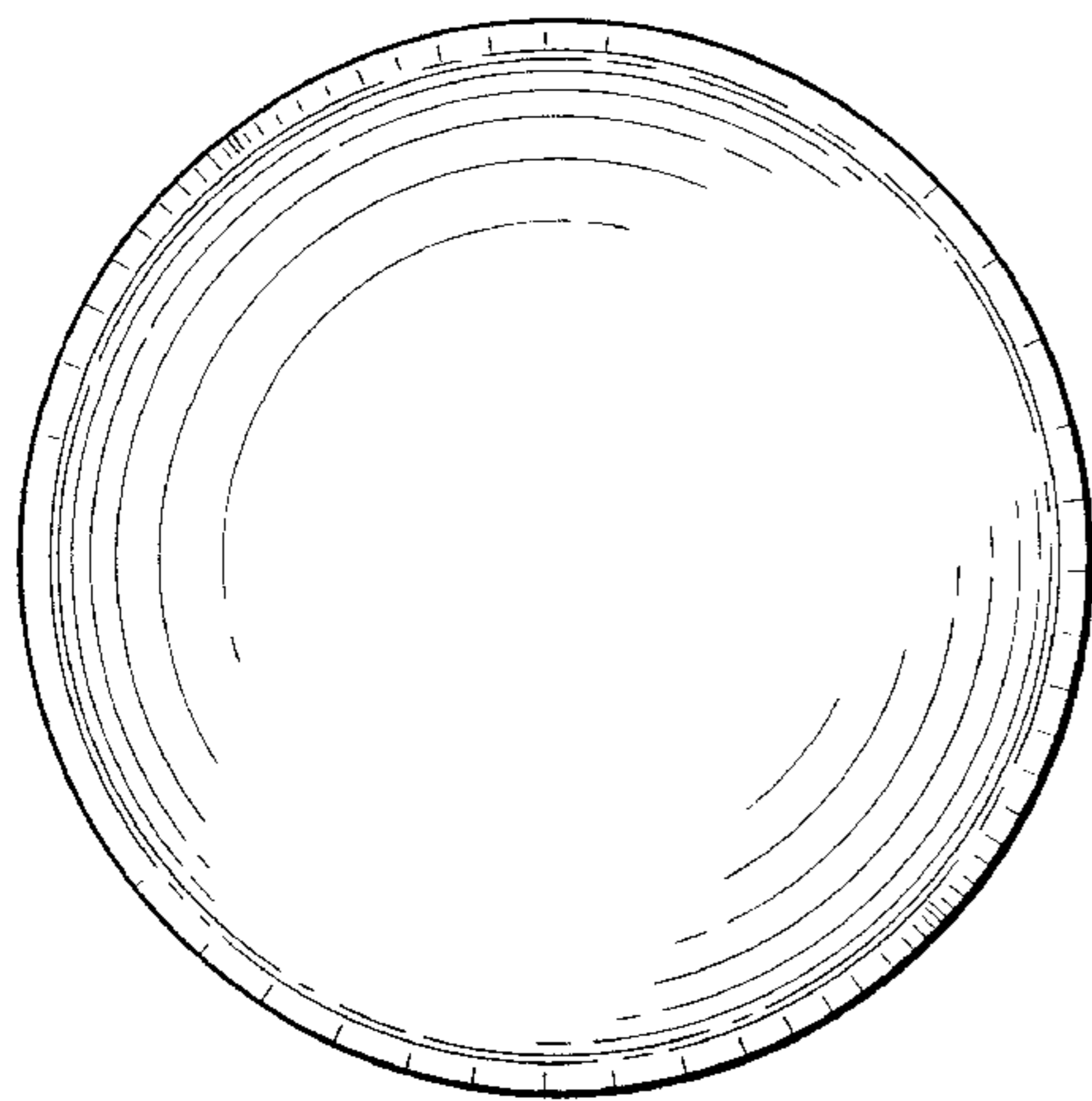

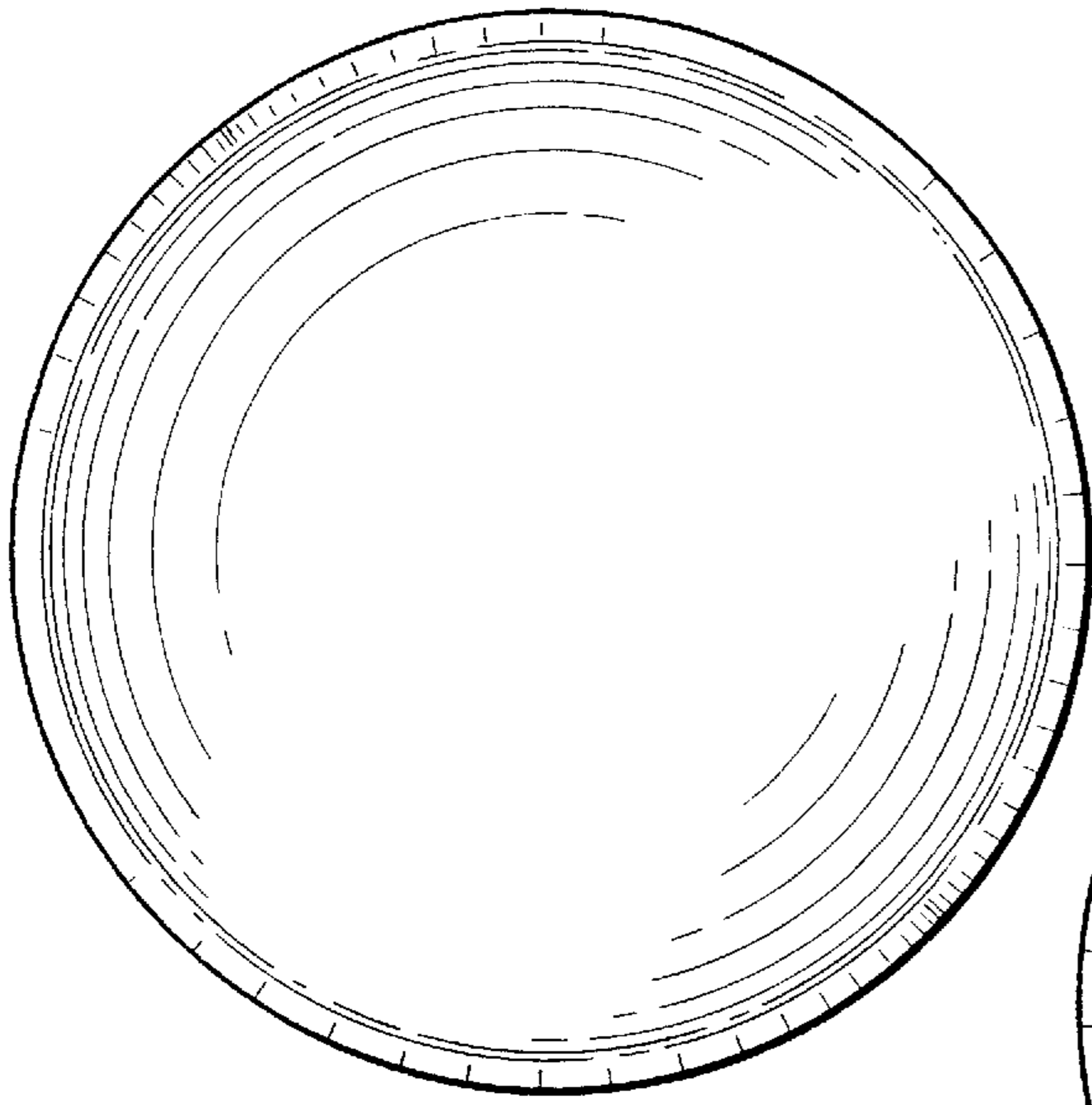

FIG. 1

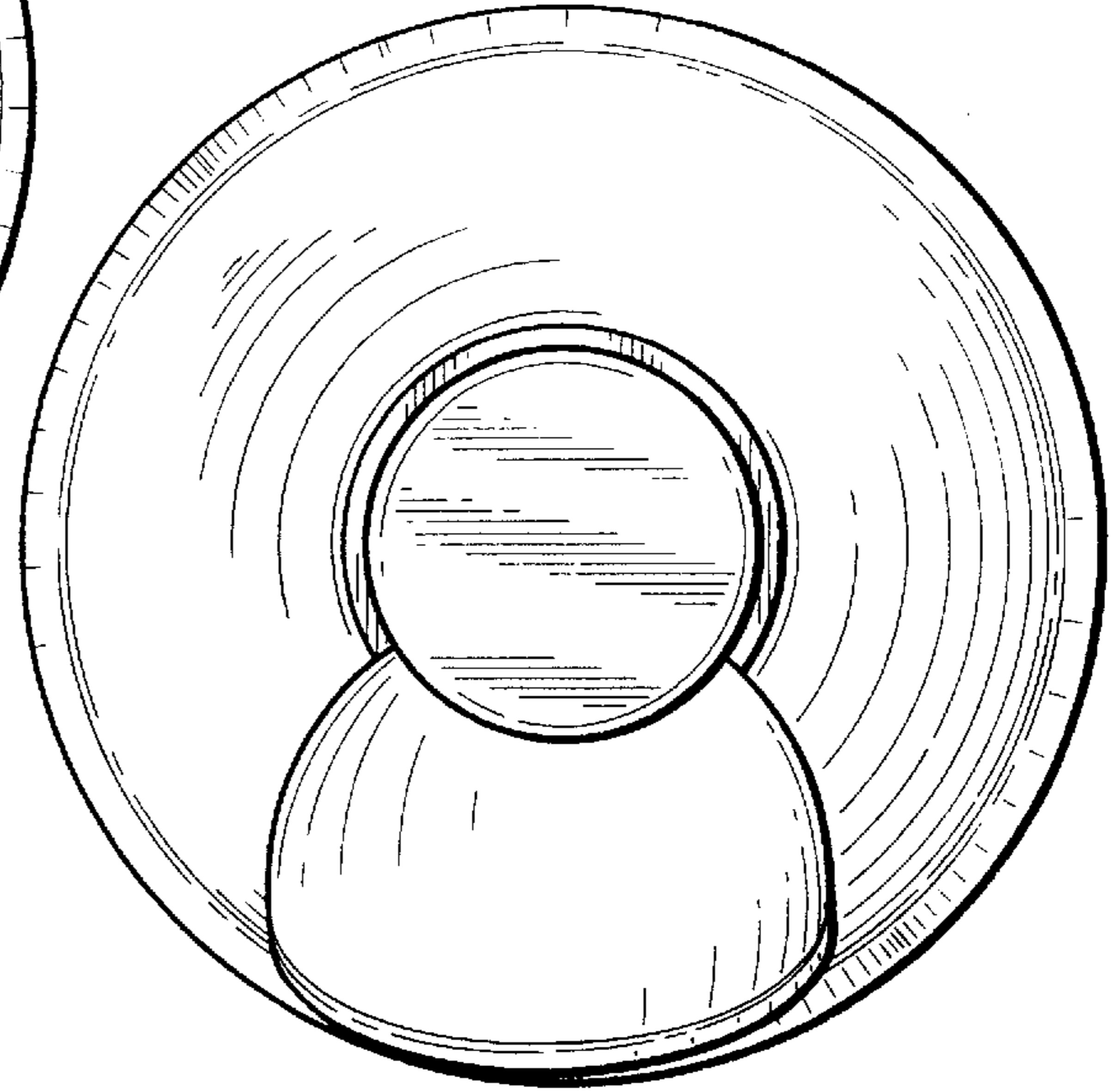

FIG. 2

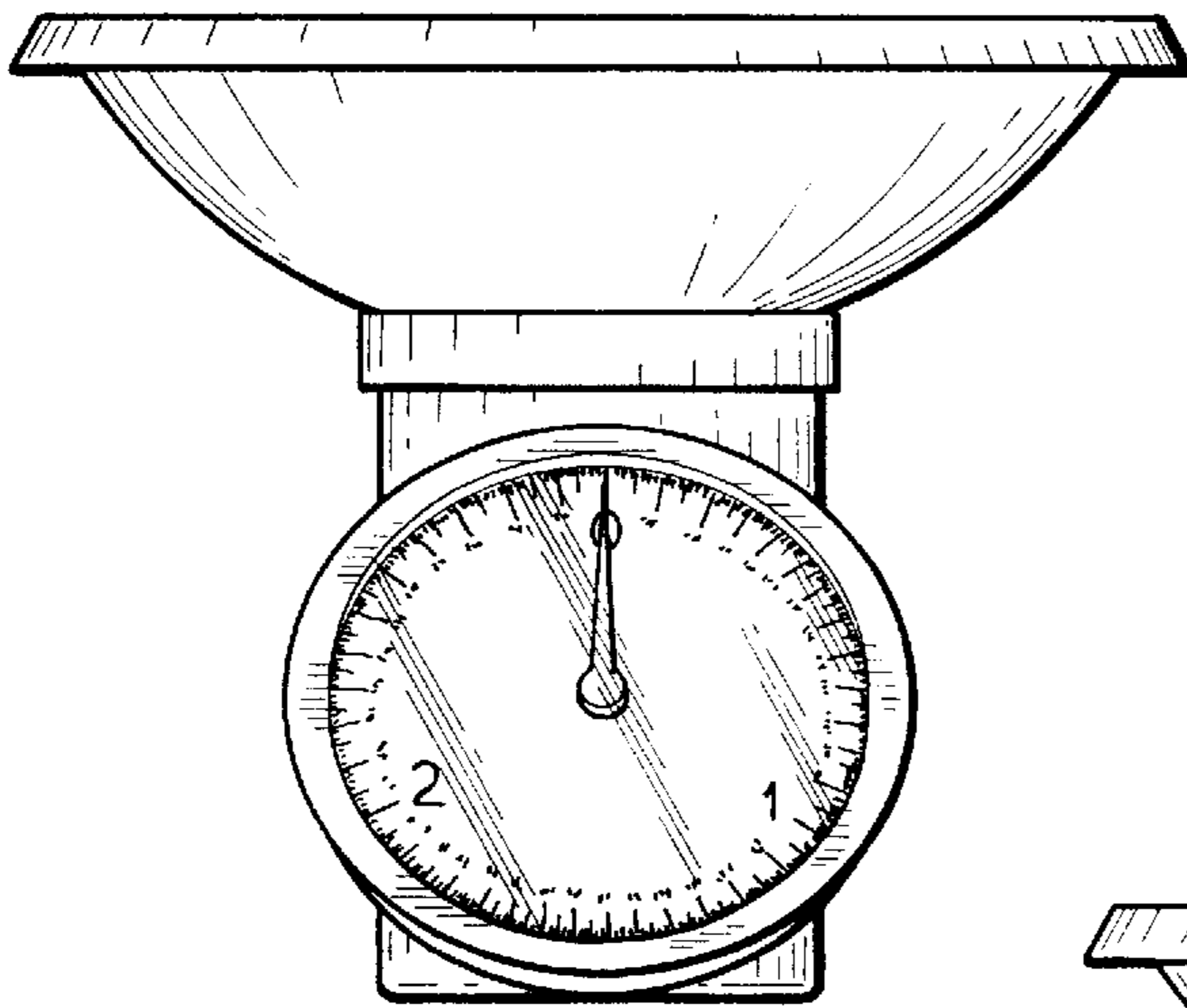

FIG. 3

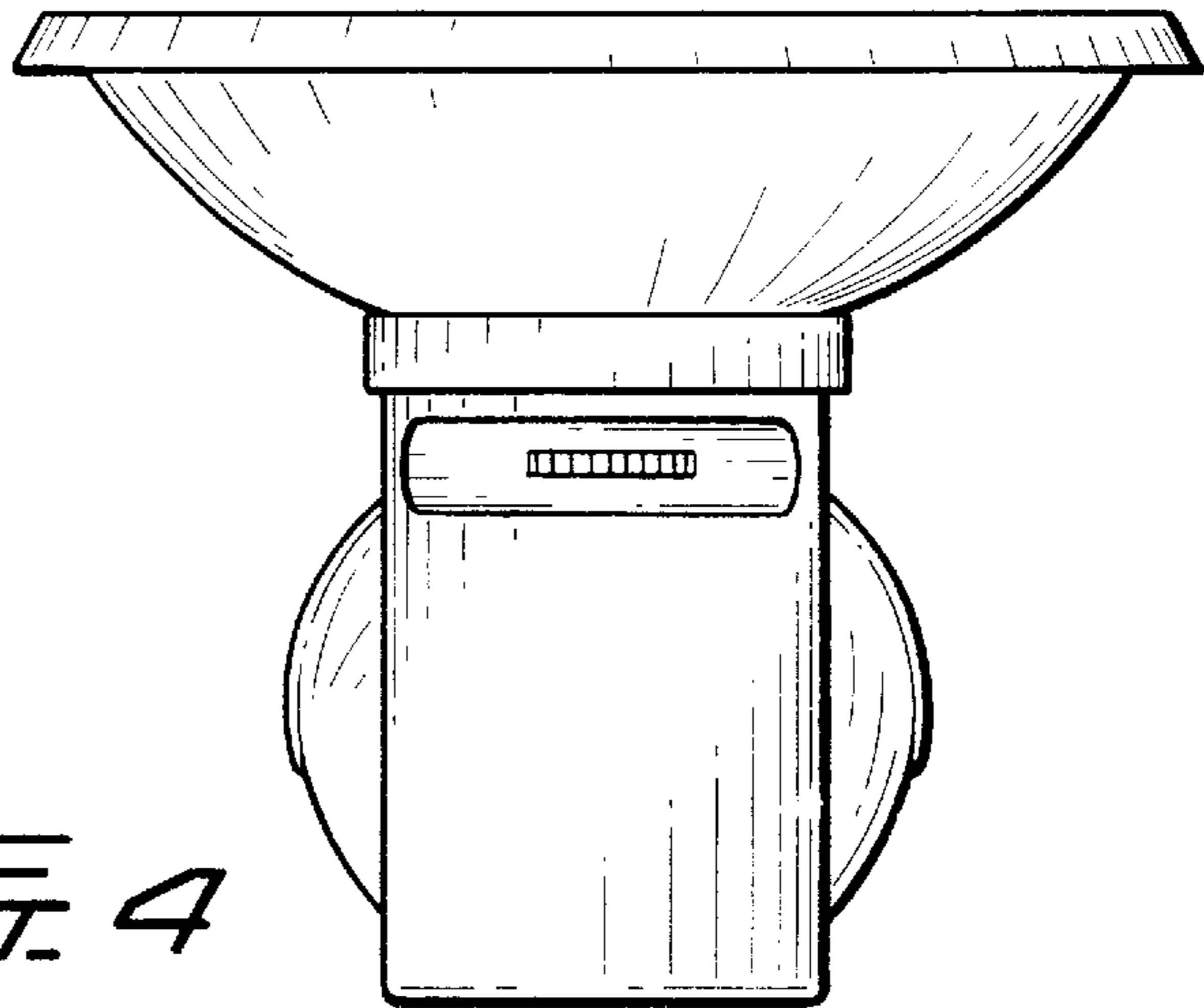

FIG. 4

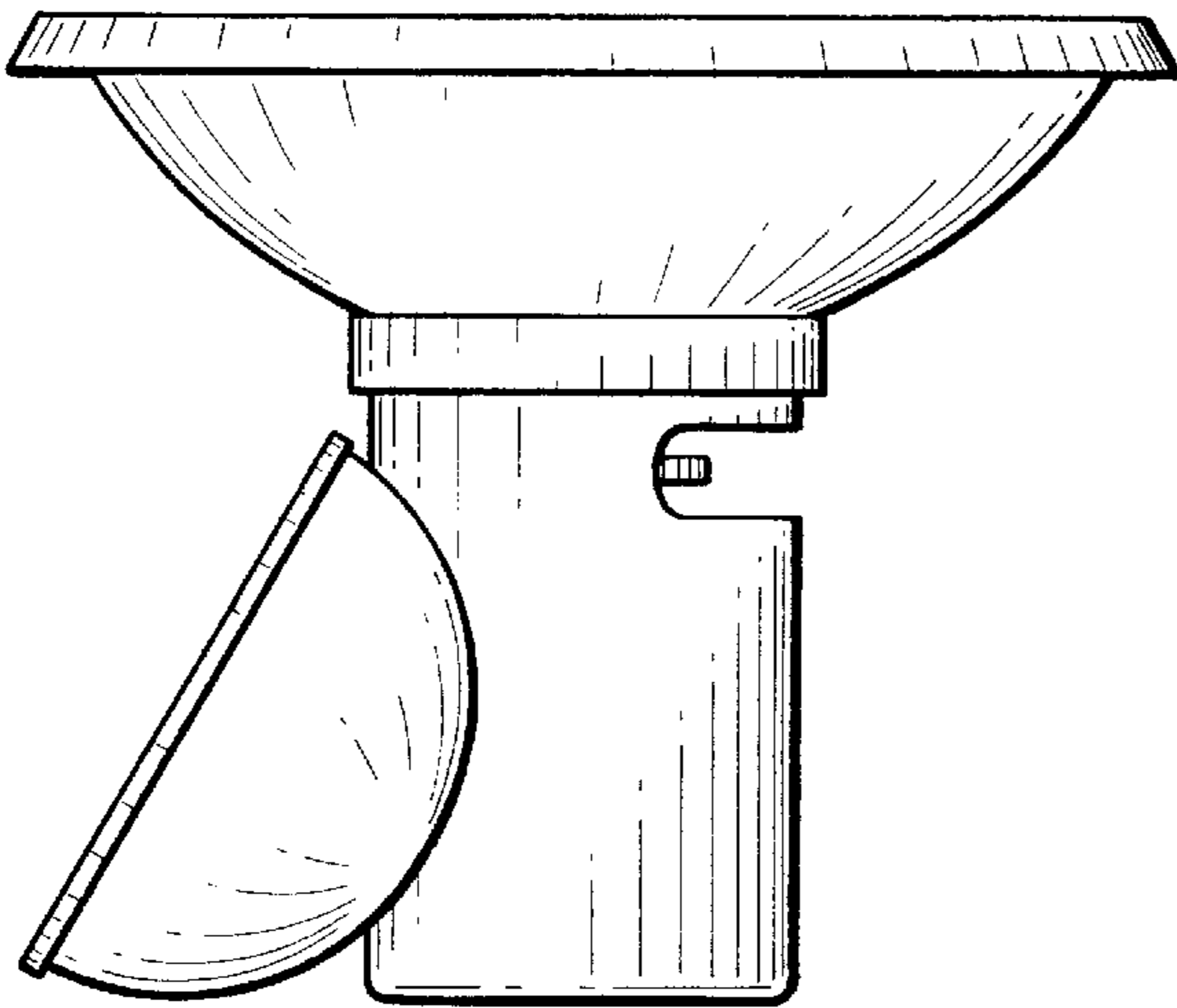

FIG. 5

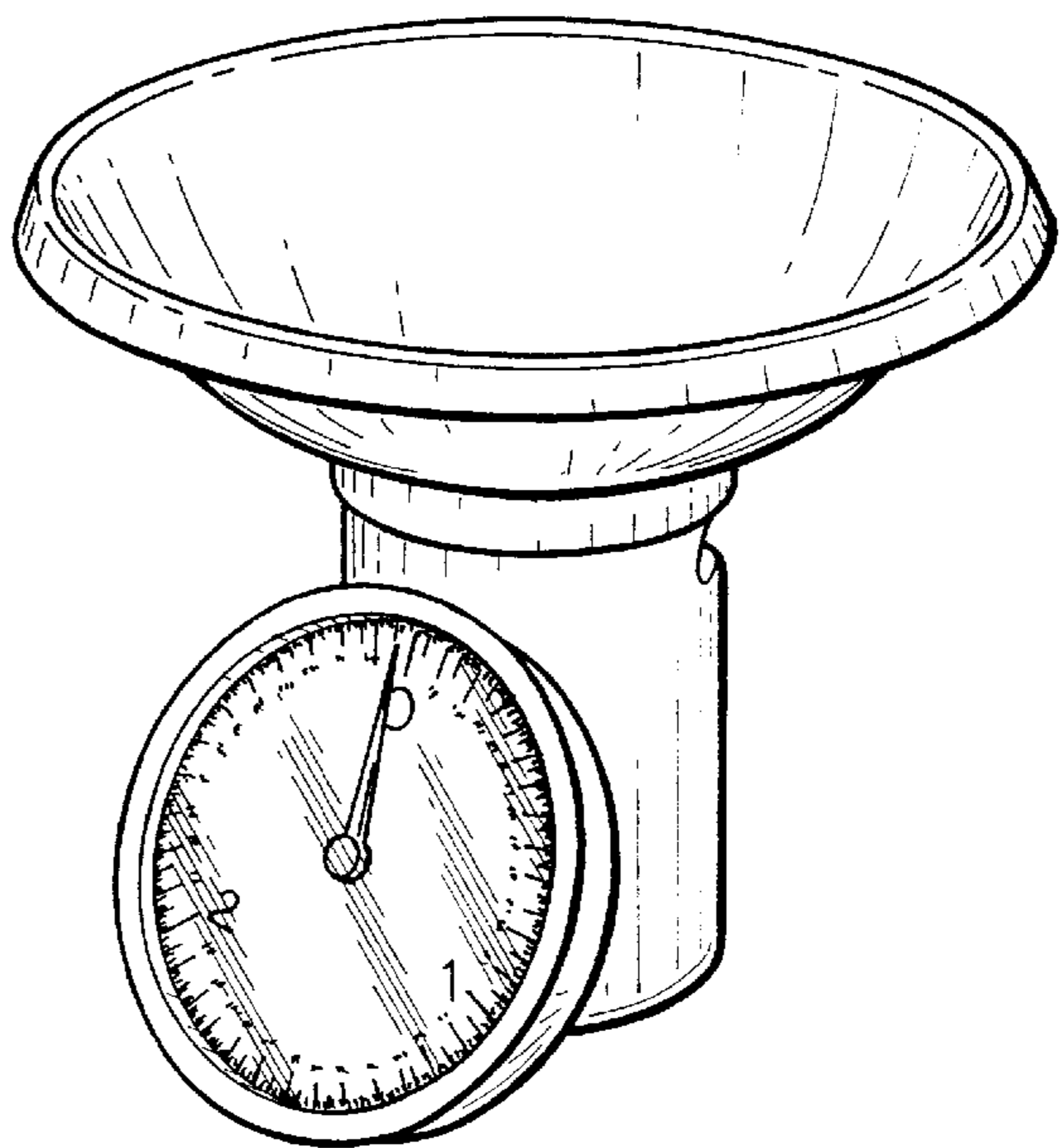

FIG. 6

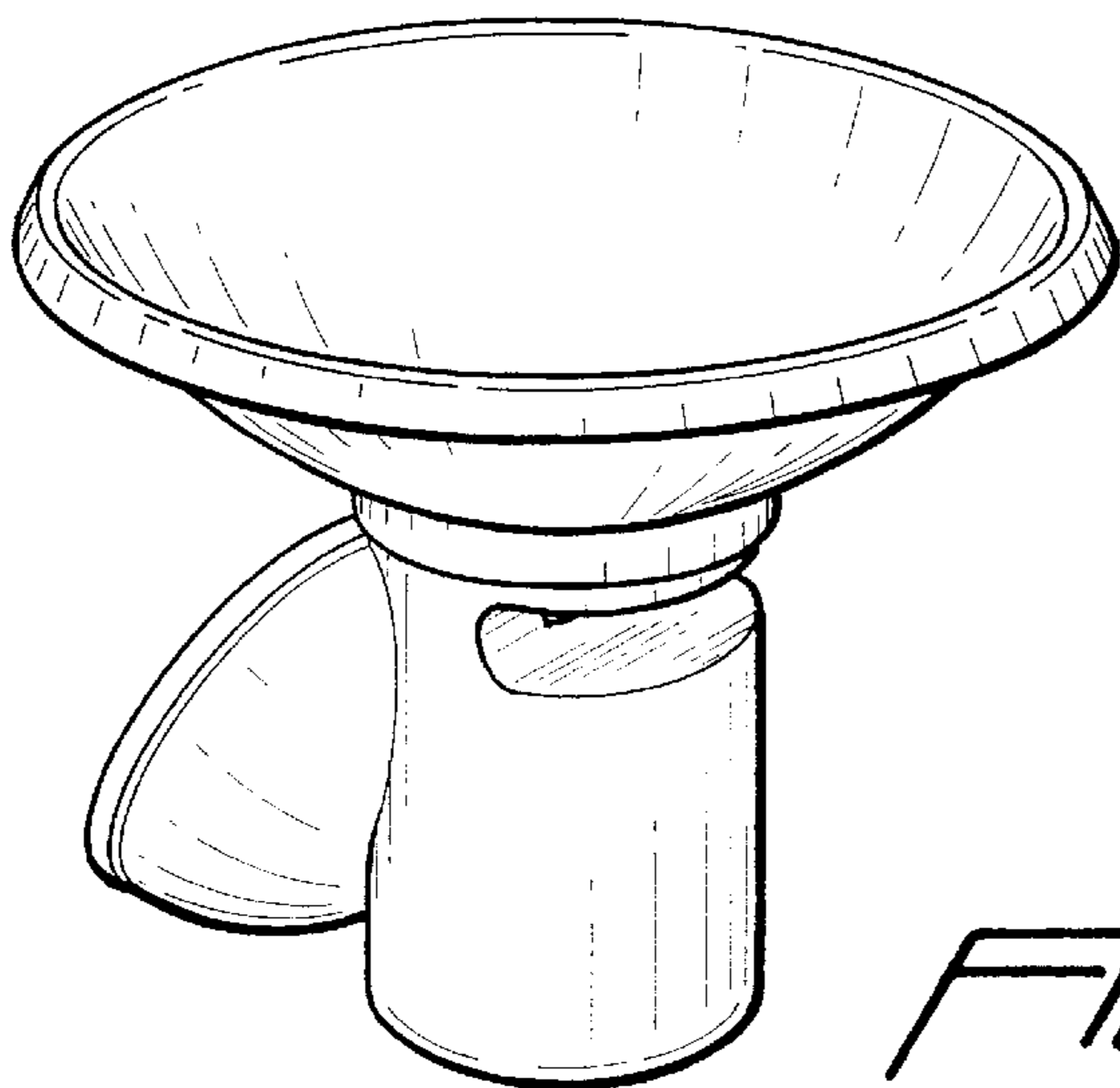

FIG. 7

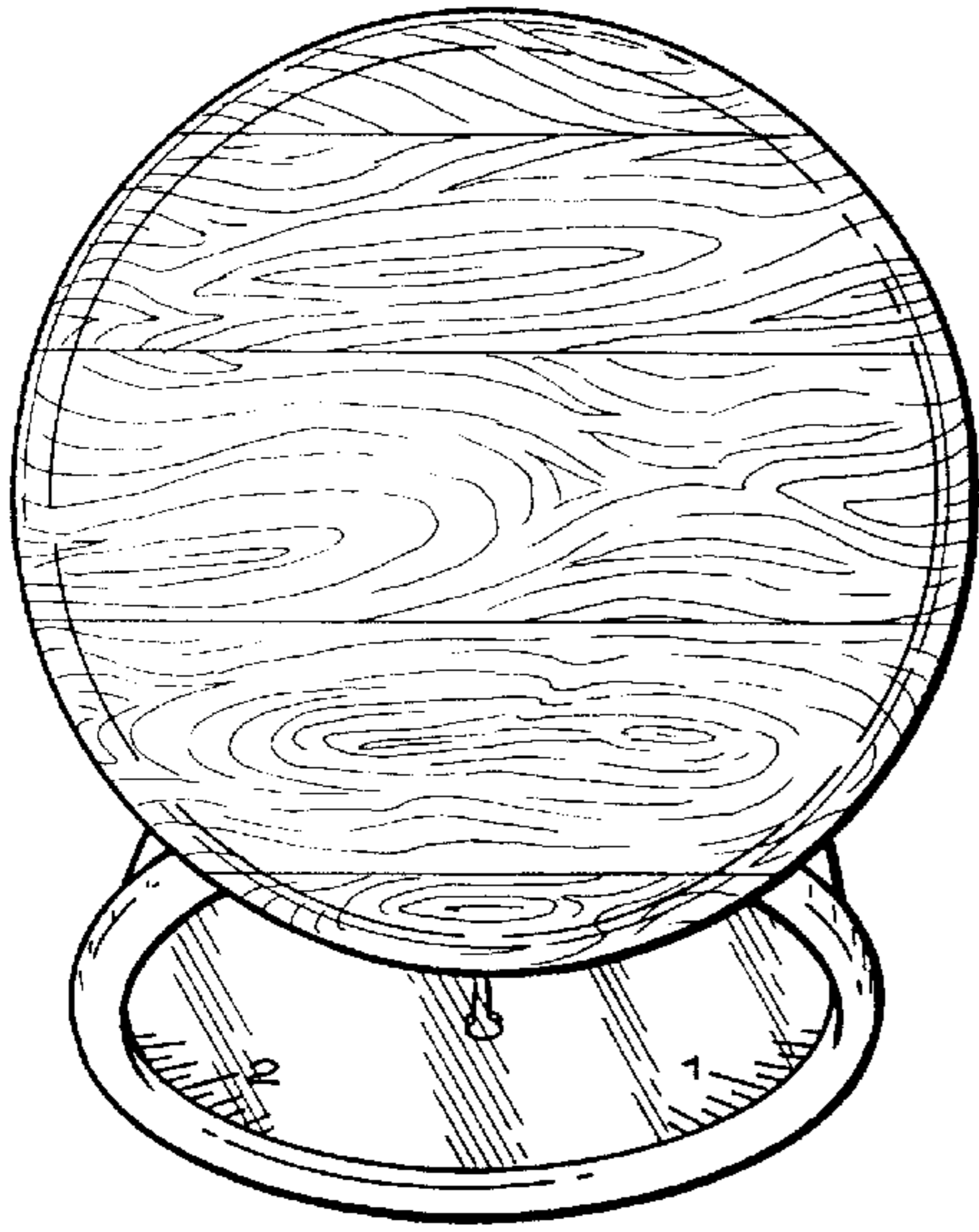

FIG. 8

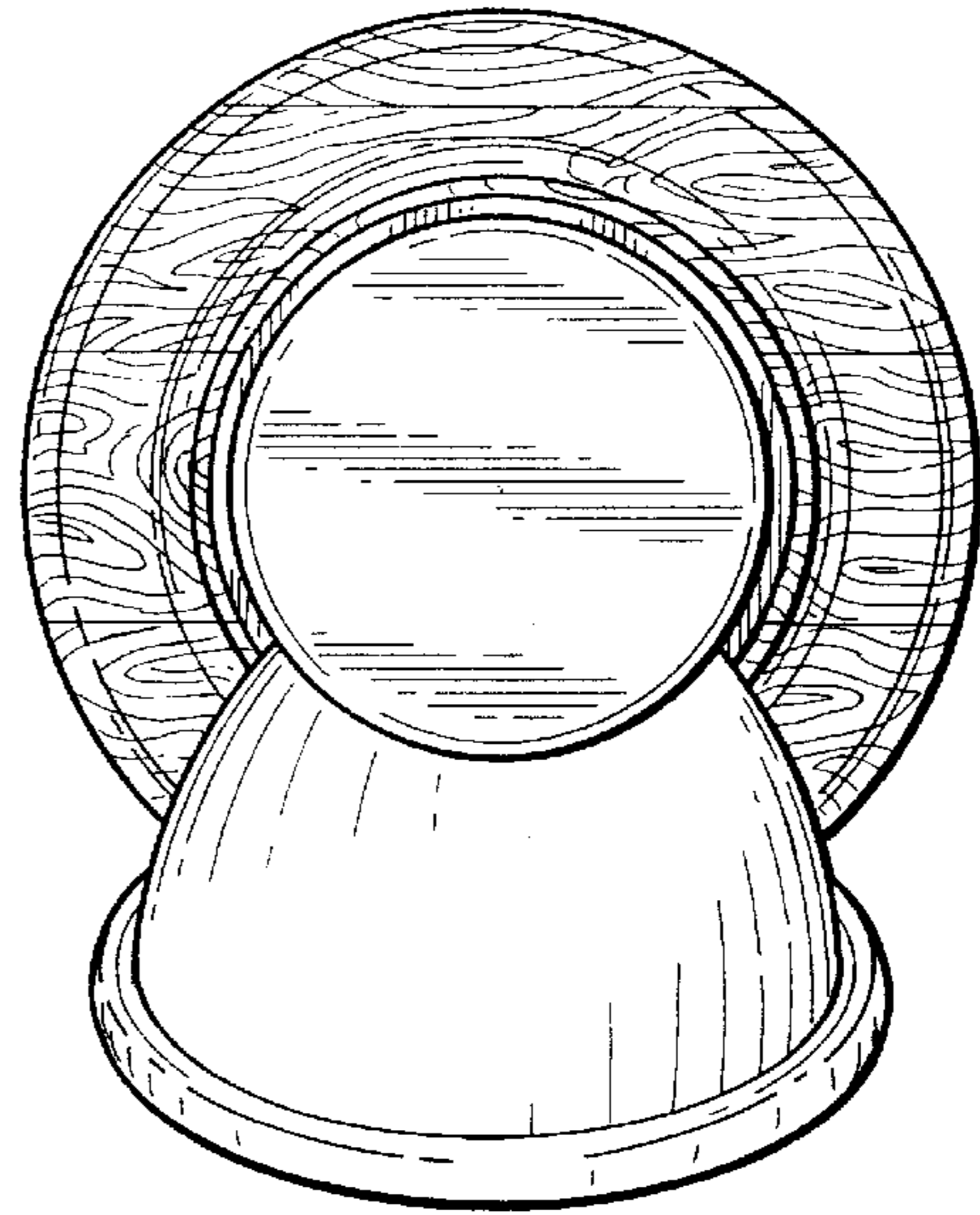

FIG. 9

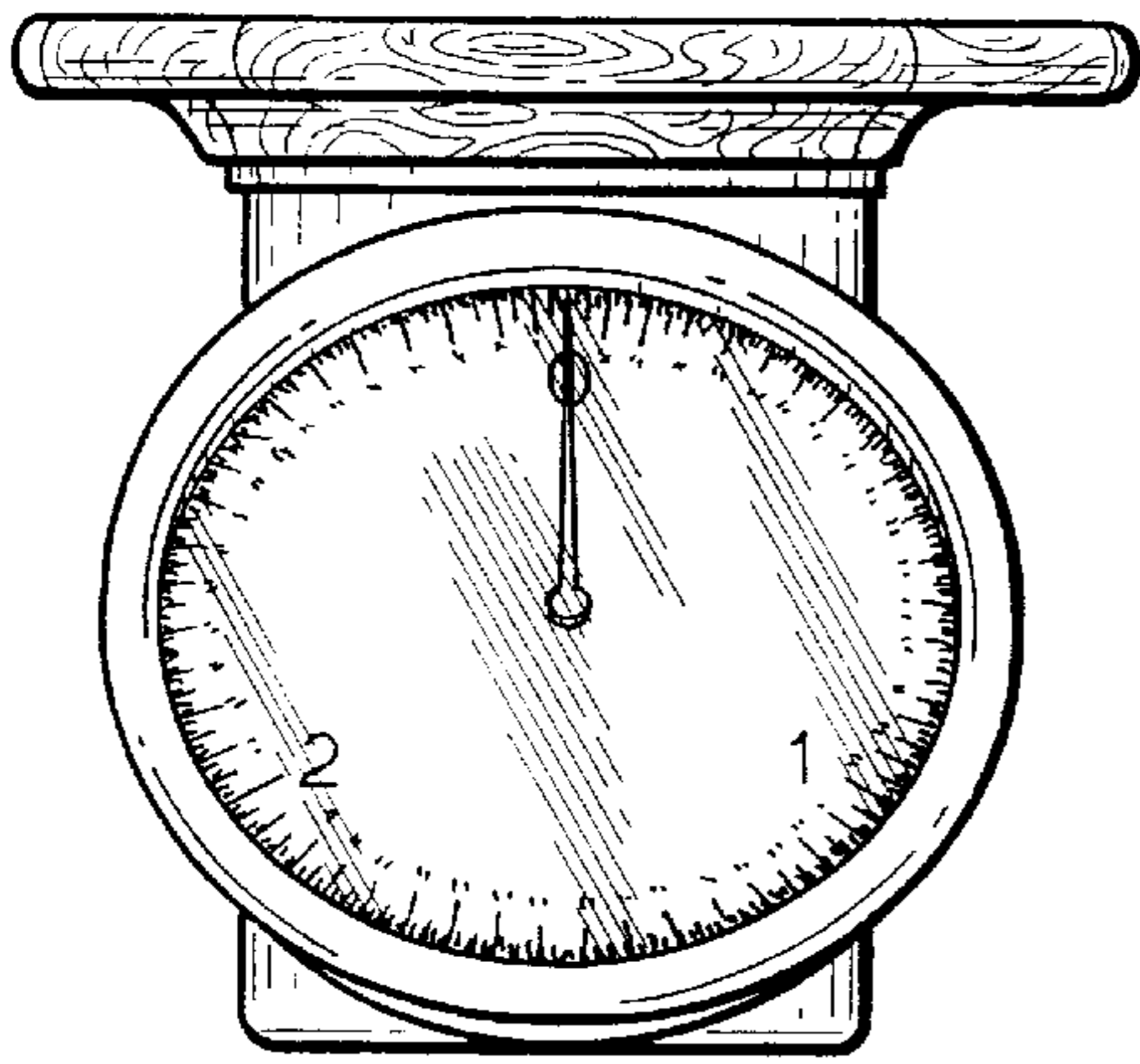

FIG. 10

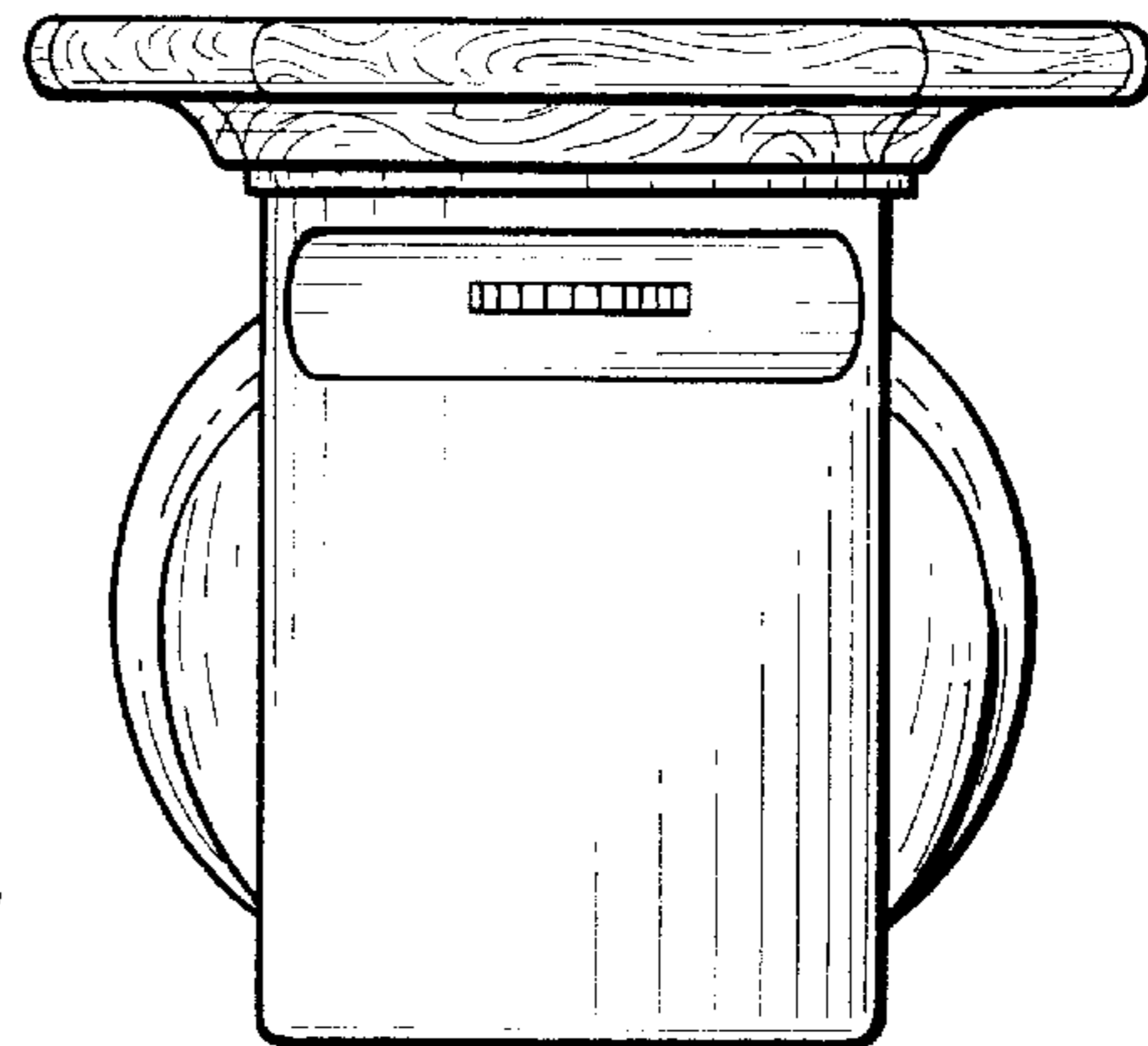

FIG. 11

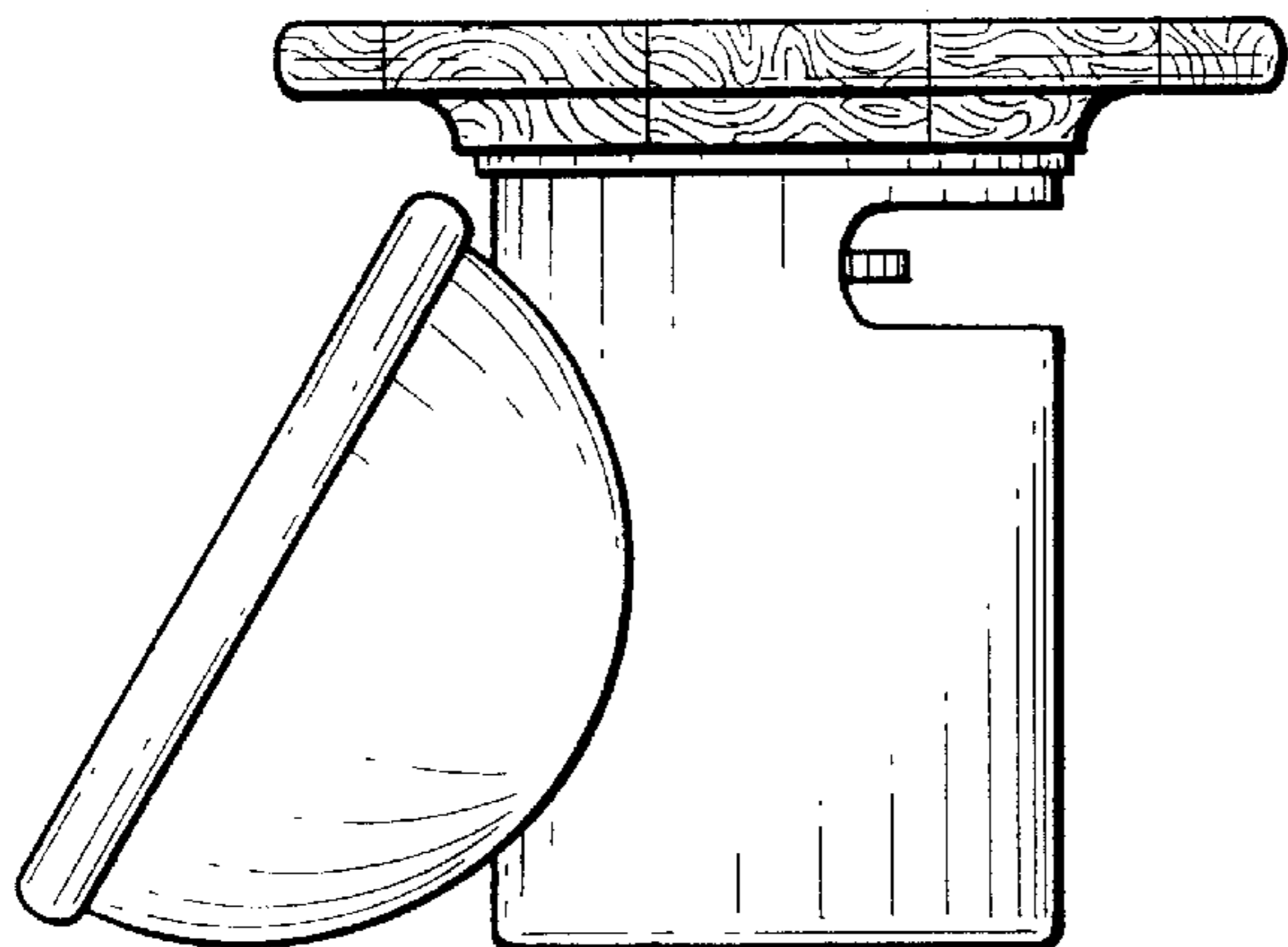

FIG. 12

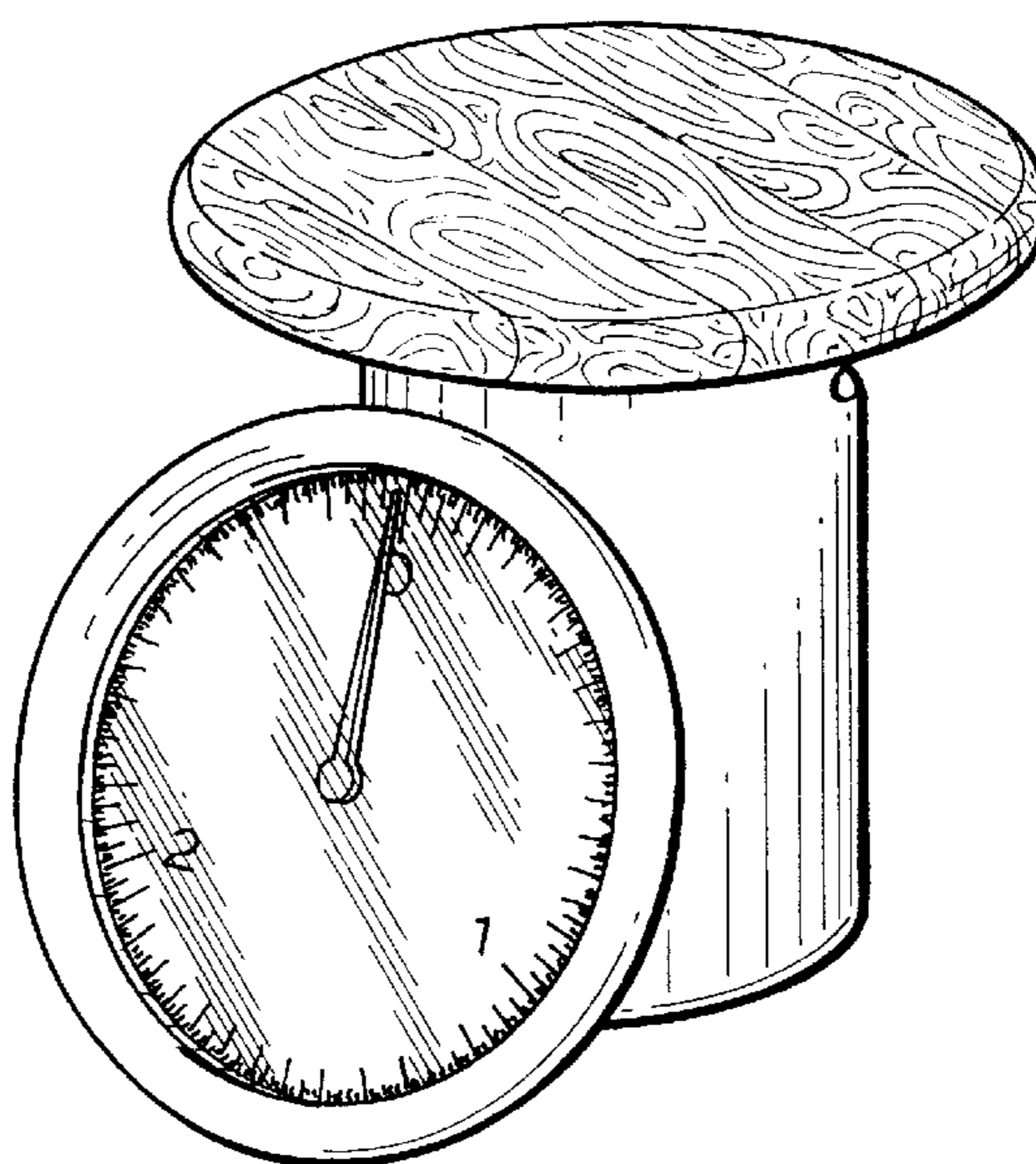

FIG. 13

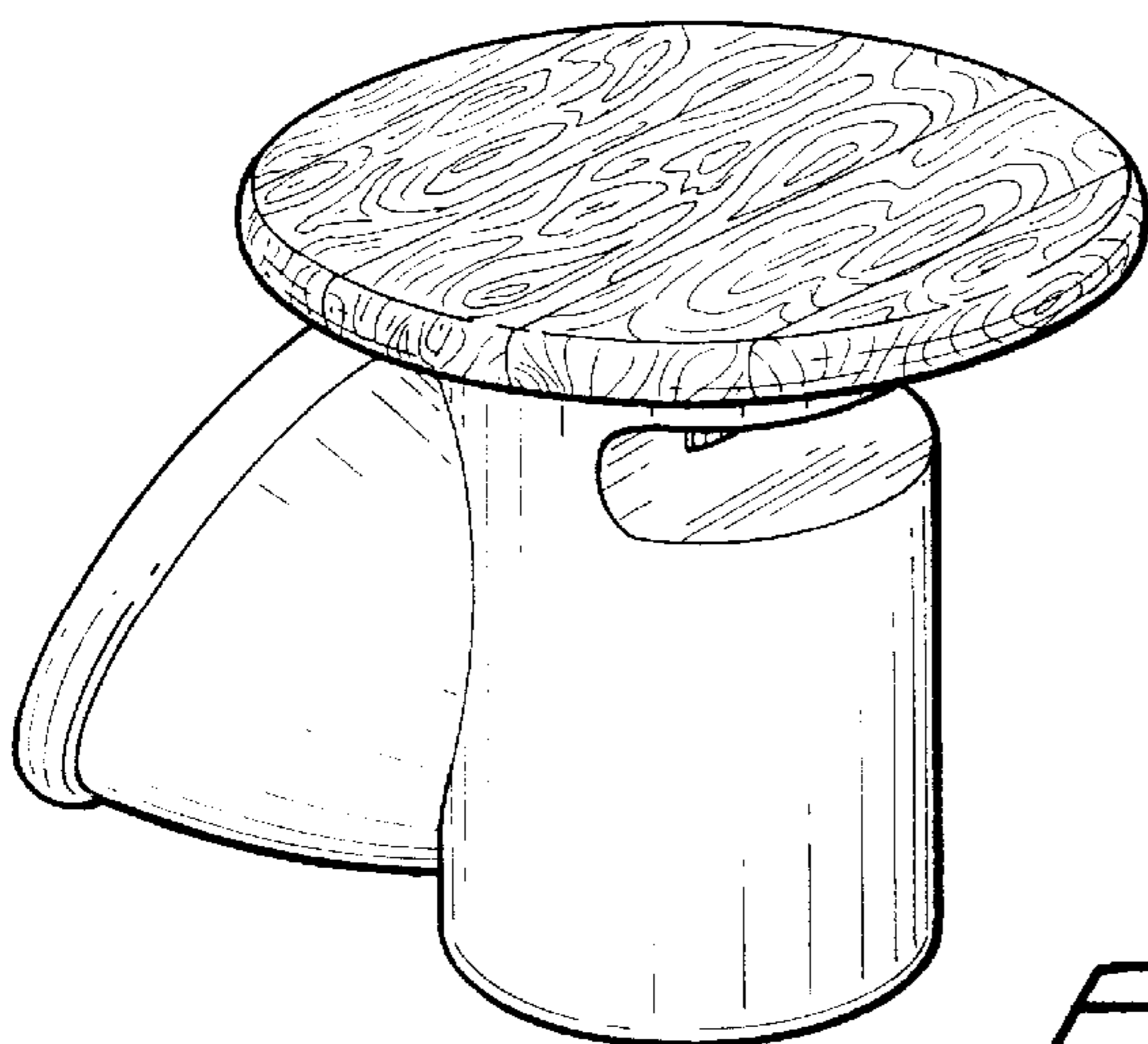

FIG. 14