



US00D411462S

United States Patent [19]
Heins

[11] **Patent Number: Des. 411,462**
[45] **Date of Patent: ** Jun. 22, 1999**

[54] **ANIMAL GRAVE MARKER**

[76] Inventor: **Kenneth L. Heins**, 3337 Highview Dr.,
Hubertus, Wis. 53033

[**] Term: **14 Years**

[21] Appl. No.: **29/085,902**

[22] Filed: **Apr. 1, 1998**

[51] **LOC (6) Cl. 19-00**

[52] **U.S. Cl. D99/18; D99/17**

[58] **Field of Search D99/17, 18, 21,**
D99/22; D20/10, 23, 29, 30, 41; 40/124.5,
300, 606, 607, 647, 584; D30/155; 119/709

[56] **References Cited**

U.S. PATENT DOCUMENTS

D. 90,907	10/1933	Baker .	
D. 153,399	4/1949	Spencer .	
D. 205,279	7/1966	Kane	D20/29
D. 233,159	10/1974	White .	
D. 384,978	10/1997	Shimogori et al.	D20/30
700,904	5/1902	Delaney .	
1,188,012	6/1916	Pope	40/647
1,276,798	8/1918	Norman .	
1,364,902	1/1921	Sullivan	40/124.5
1,455,882	5/1923	Harding .	
1,573,263	2/1926	Norman .	
3,608,220	9/1971	Fryrear .	
3,977,110	8/1976	Yerger .	
5,474,033	12/1995	Mitchell, Jr.	D30/155 X
5,752,335	5/1998	Shimogori et al.	40/300

Primary Examiner—Paula A. Mortimer
Attorney, Agent, or Firm—Robert T. Johnson

[57] **CLAIM**

I claim a new ornamental design for animal grave marker, as shown and described.

DESCRIPTION

FIG. 1 is a front elevational view of an animal grave marker showing my new design;

FIG. 2 is a left side elevational view, and the right side elevational view is a mirror image of the left side elevational view;

FIG. 3 is a rear elevational view thereof;

FIG. 4 is a top plan view thereof;

FIG. 5 is a bottom plan view thereof;

FIG. 6 is a front elevational view of a second embodiment of an animal grave marker showing my new design;

FIG. 7 is a left side elevational view of the second embodiment for my new design and the right side is a mirror image thereof;

FIG. 8 is a rear elevational view of the second embodiment for ornamental design for animal grave marker;

FIG. 9 is a top plan view thereof;

FIG. 10 is a bottom plan view thereof;

FIG. 11 is a front perspective view of the embodiment of FIG. 1; and,

FIG. 12 is a front perspective view of the embodiment of FIG. 6.

The stem is shown broken away in the FIGS. 1, 2, 3, 6, 7, 8, 11 and 12 to indicate indeterminate length.

The broken line showing of the words Name, Born, and Died in FIGS. 1, 3, 6, 8, 11, and 12 is for illustrative purposes only and forms no part of the claimed design.

1 Claim, 6 Drawing Sheets

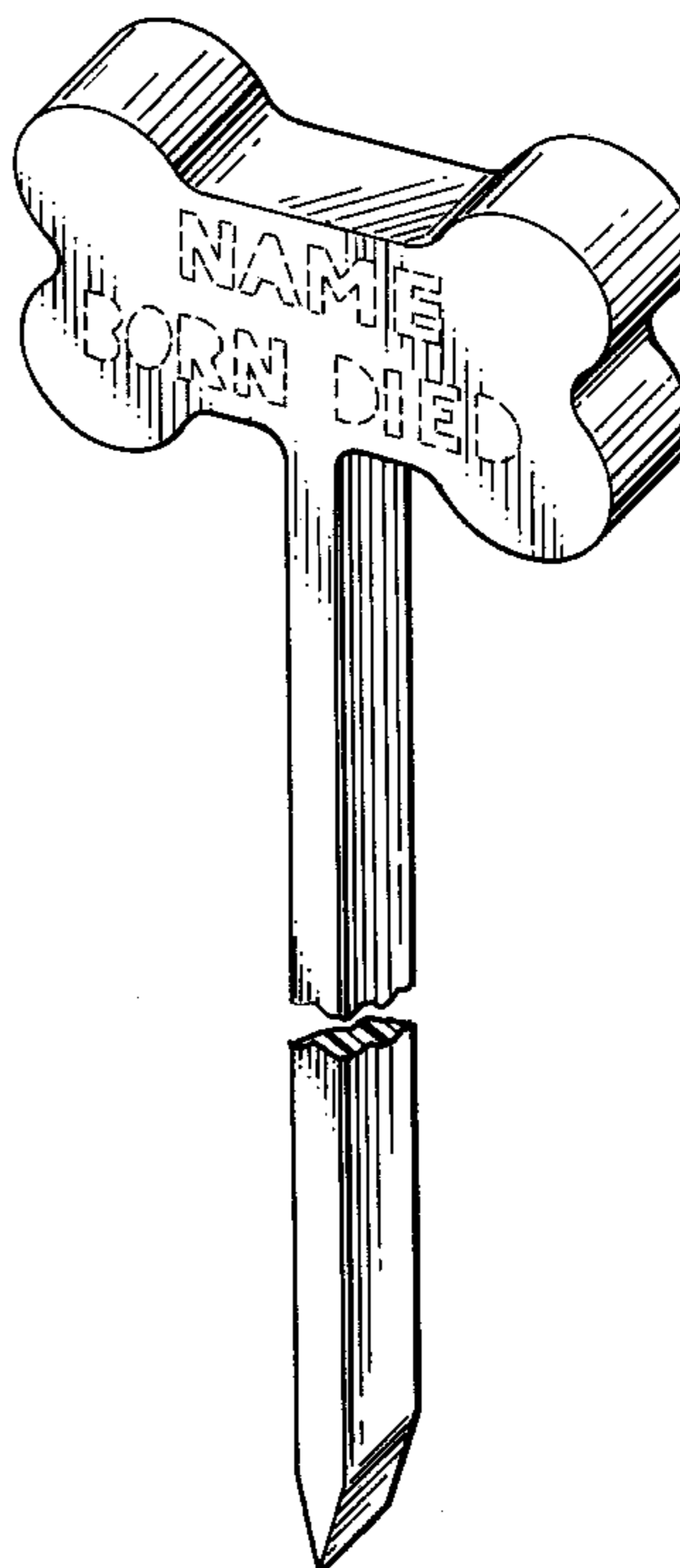
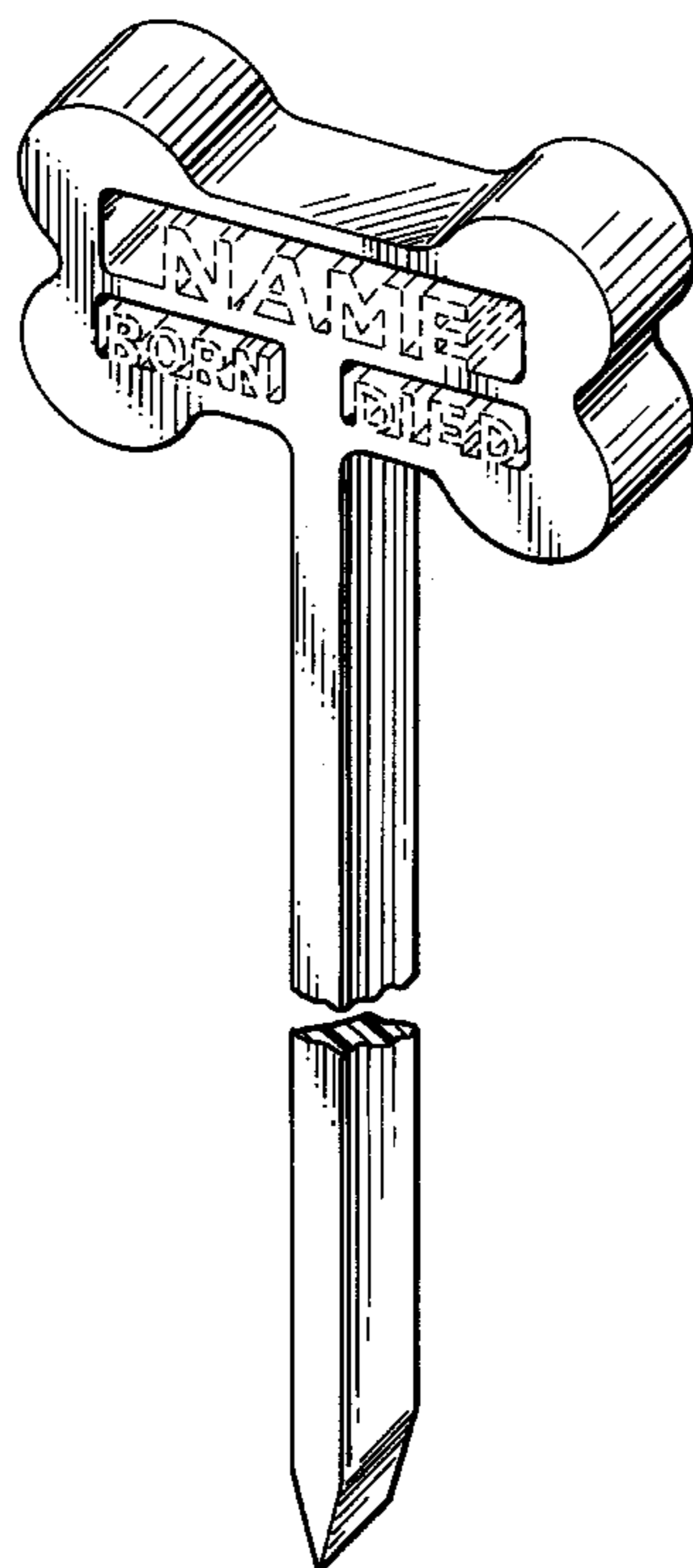

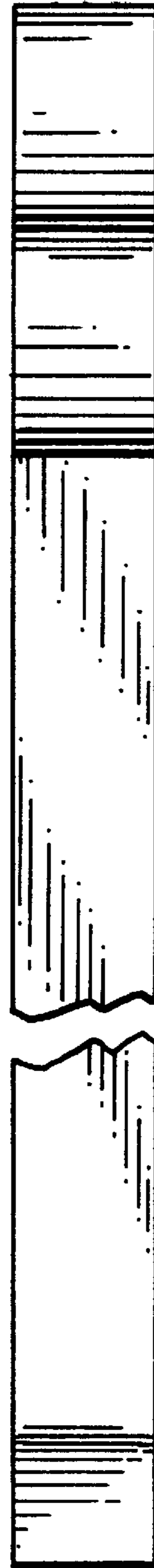
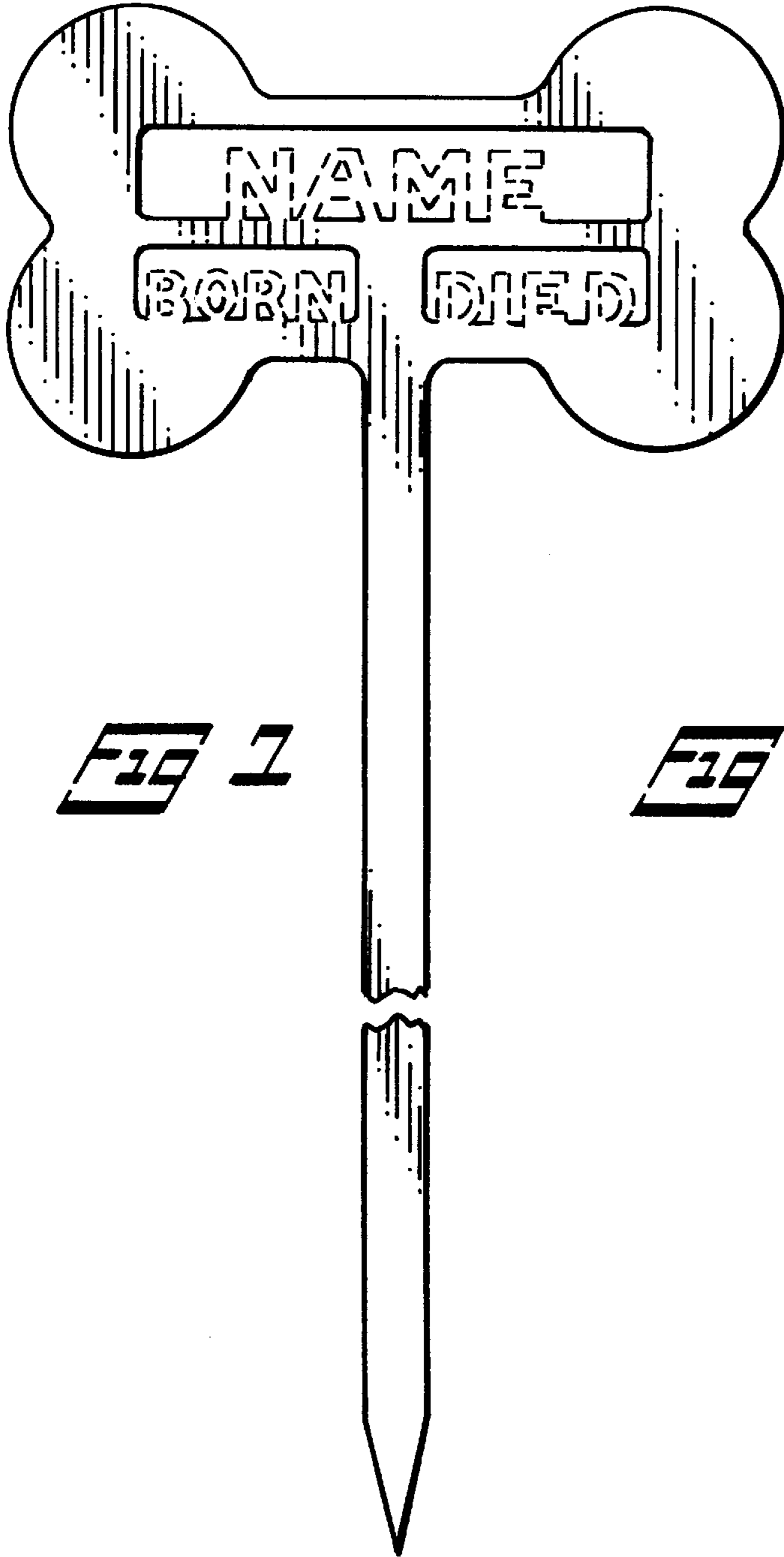

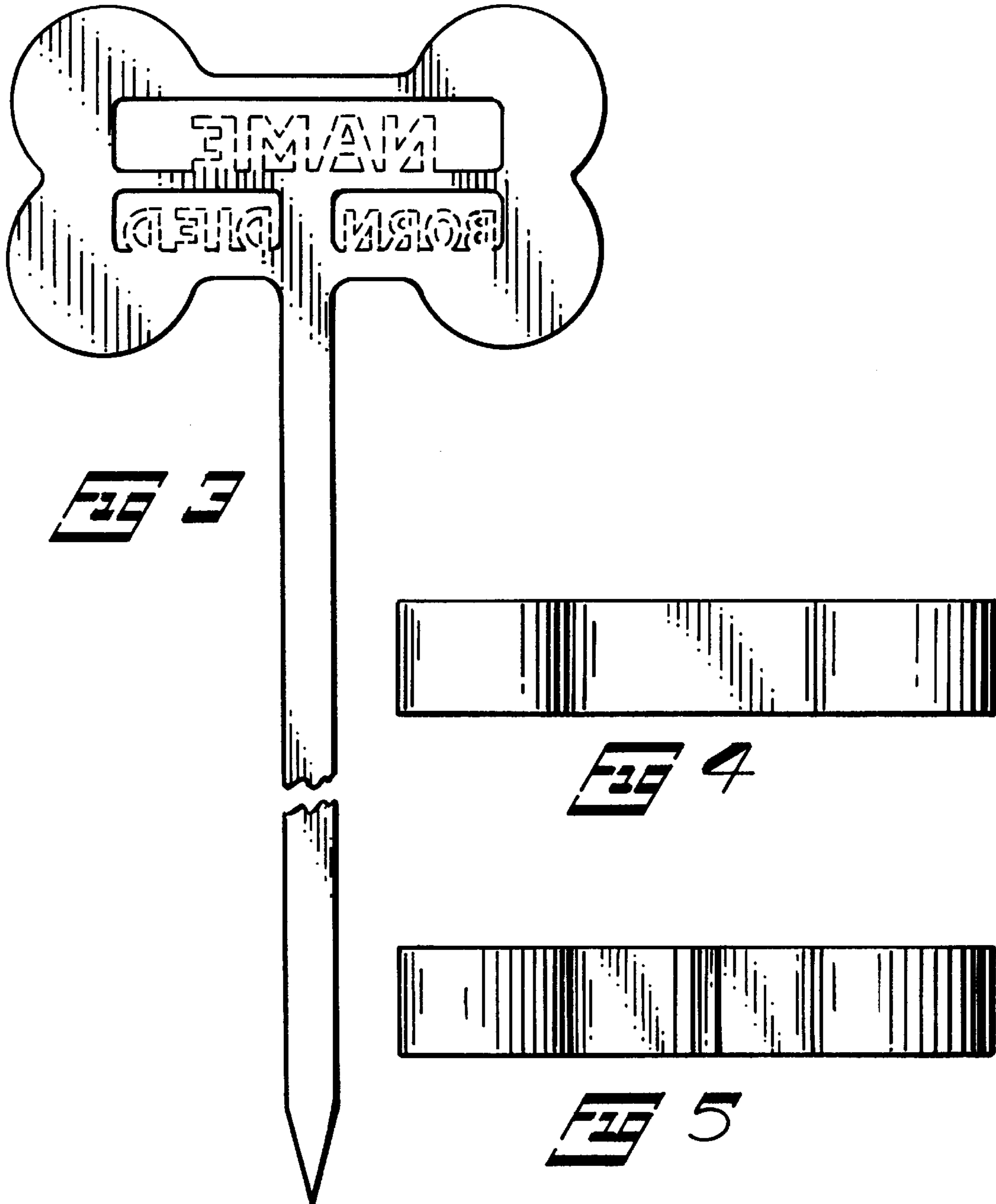

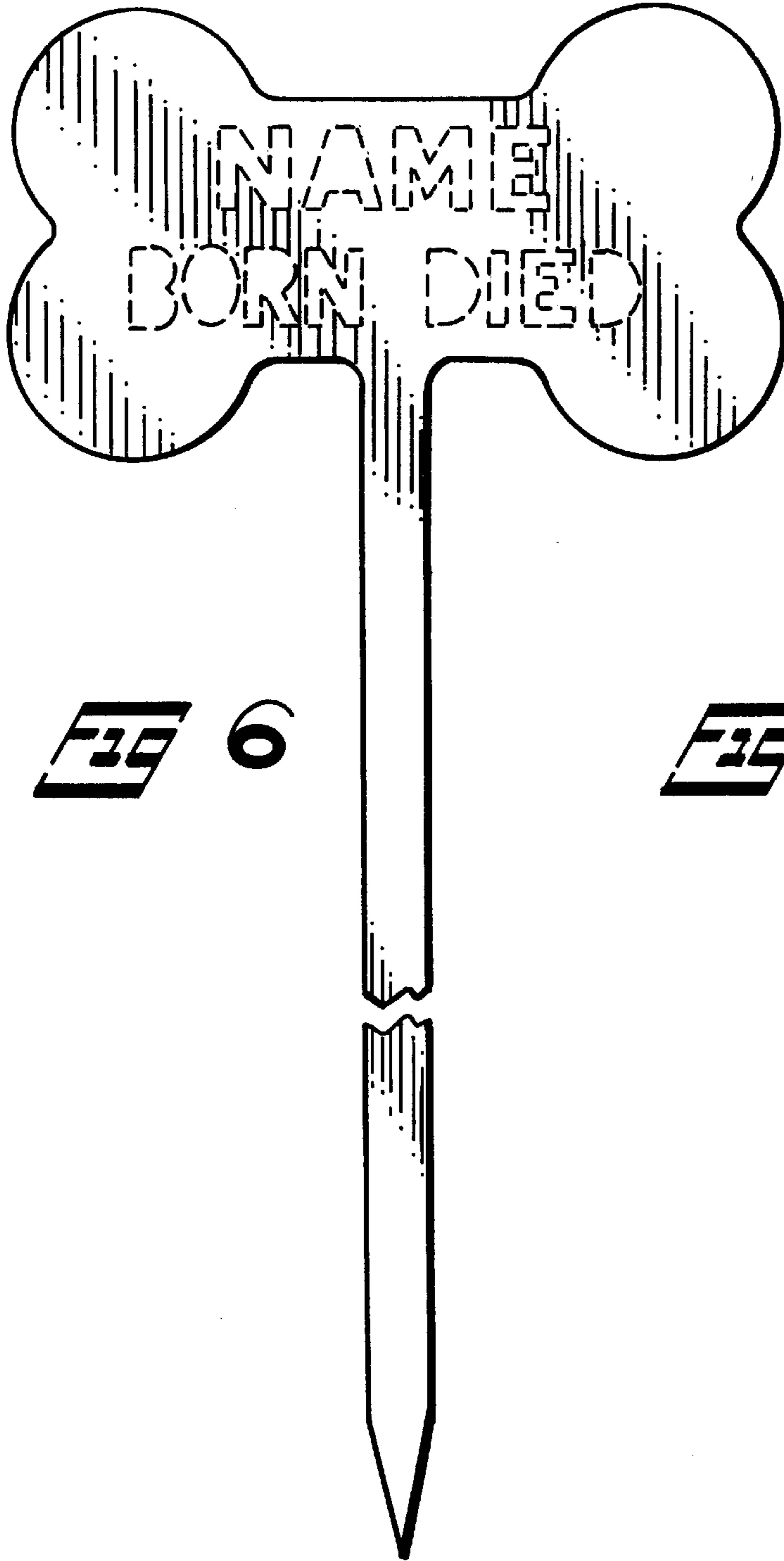

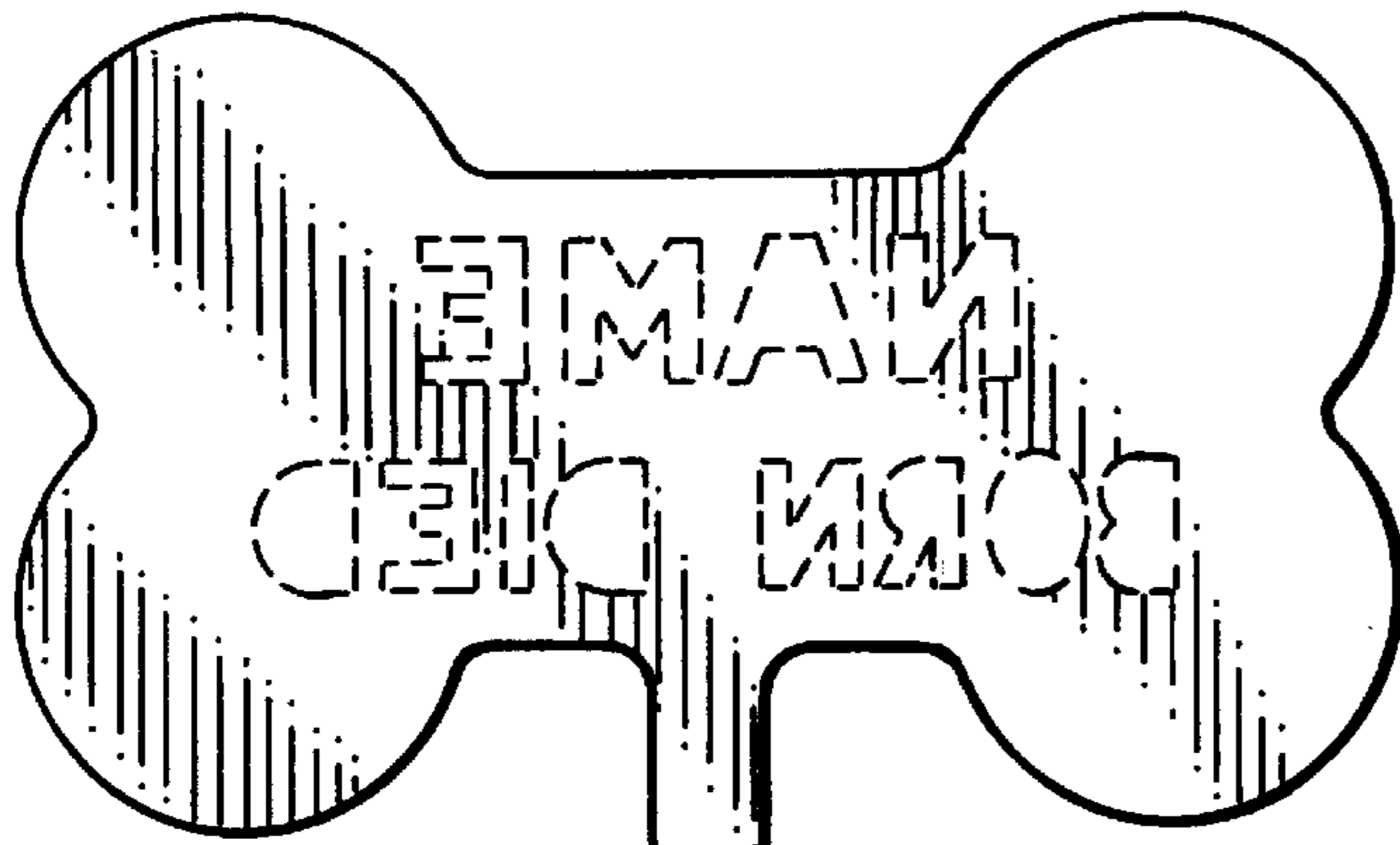

FIG 8

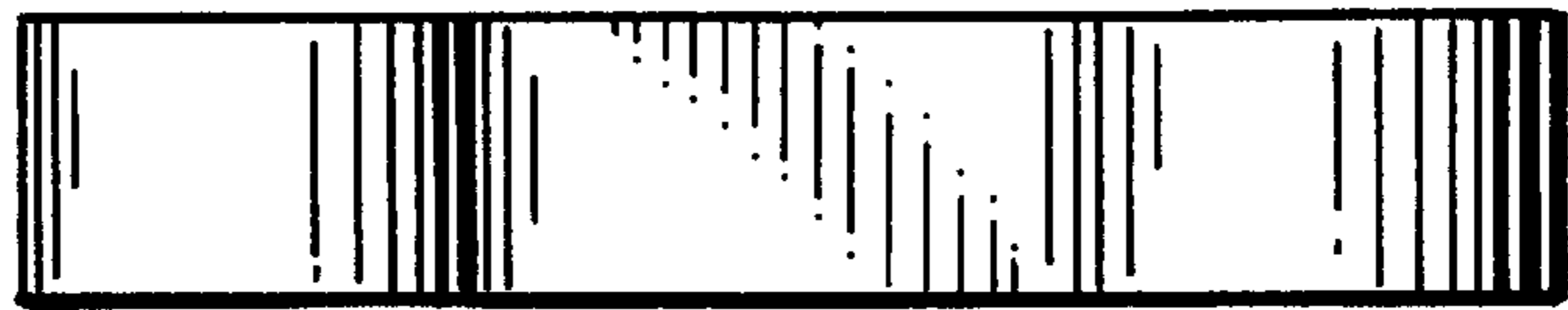

FIG 9



FIG 10

