



US00D411447S

United States Patent [19]
Melzer

[11] **Patent Number: Des. 411,447**
[45] **Date of Patent: ** Jun. 22, 1999**

[54] **PACKAGE**

[75] Inventor: **Steven Melzer**, Marlboro, N.J.

[73] Assignee: **Ballarini, Paolo & Figli SpA**, Rivarolo Mantovano, Italy

[**] Term: **14 Years**

[21] Appl. No.: **29/084,643**

[22] Filed: **Mar. 6, 1998**

[51] **LOC (6) Cl.** **09-07**

[52] **U.S. Cl.** **D9/415**

[58] **Field of Search** D9/415, 418, 414,
D9/346, 433; 206/45.28, 45.29, 303, 304.1,
304.2, 462, 471, 495, 806, 775-779

[56] **References Cited**

U.S. PATENT DOCUMENTS

D. 354,679	1/1995	Dunn	D9/415
D. 371,070	6/1996	Brier	D9/415
3,767,043	10/1973	Margolis et al.	206/775 X
3,912,074	10/1975	Vargo	206/779
4,315,569	2/1982	Jaeschke	206/779 X
4,400,161	8/1983	Gerlt	206/760 X
5,495,937	3/1996	Fraser	206/775 X
5,622,258	4/1997	Baublitz et al.	206/779 X

Primary Examiner—Prabhakar Deshmukh
Attorney, Agent, or Firm—Lawrence G. Fridman

[57] **CLAIM**

The ornamental design for a package, as shown and described.

DESCRIPTION

FIG. 1 is a perspective view of a package in an assembled condition showing my new design;
FIG. 2 is a top plan view thereof;
FIG. 3 is a bottom plan view thereof;
FIG. 4 is a front elevational view thereof;
FIG. 5 is a rear elevational view thereof;
FIG. 6 is a right side elevational view thereof;
FIG. 7 is a left side elevational view thereof;
FIG. 8 is a plan view thereof; in an unfolded condition;
FIG. 9 is a partial plan view of second modified embodiment thereof; and,
FIG. 10 is a partial plan view of a third modified embodiment thereof.

The broken line showing of an article is for illustrative purpose and forms no part of the claim. The corresponding views of the second embodiment (FIG. 9) and third embodiment (FIG. 10) are similar to FIGS. 2-7 of the first embodiment (FIG. 1) with the exception of the differences of the central portions as shown in FIGS. 9 and 10.

1 Claim, 4 Drawing Sheets

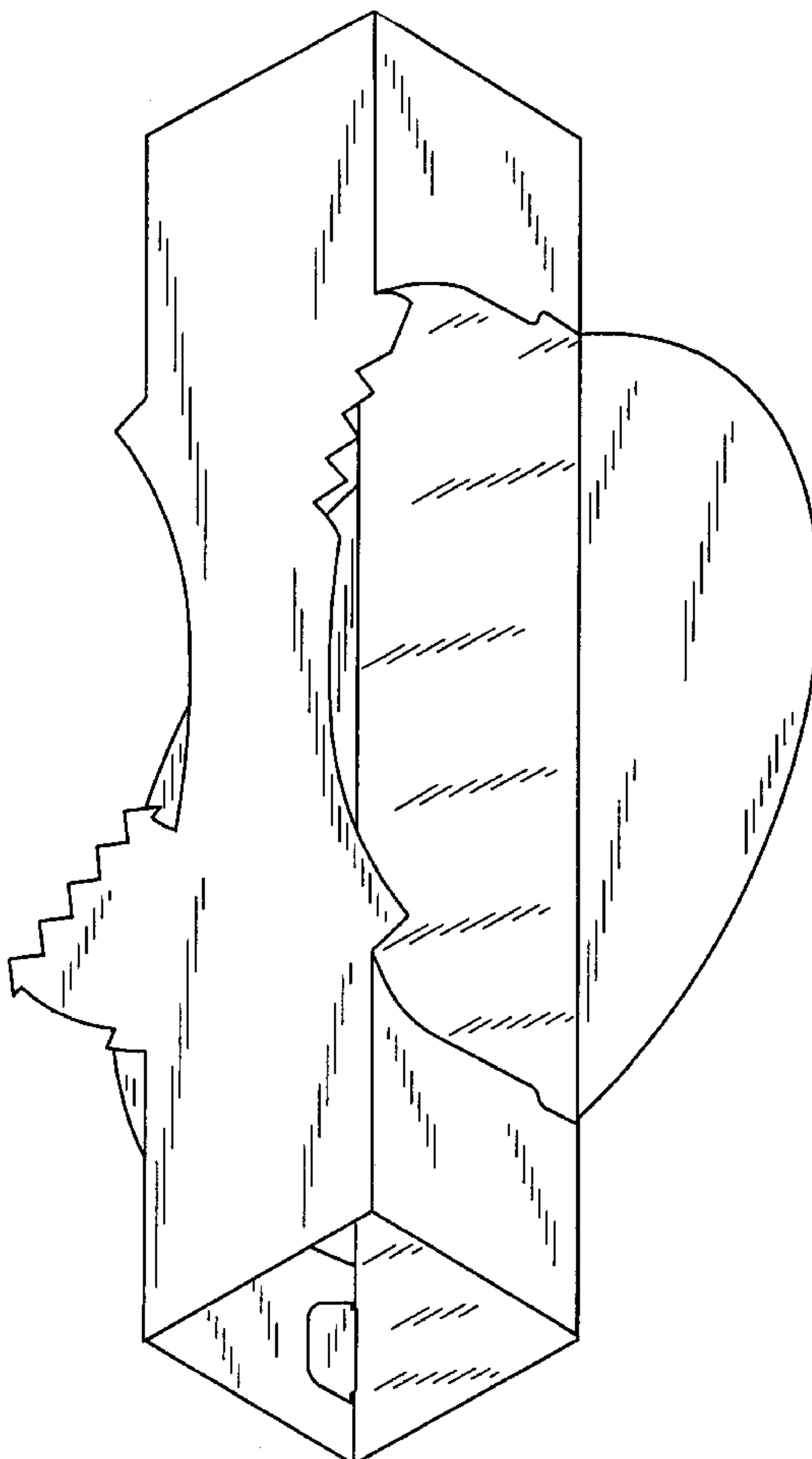

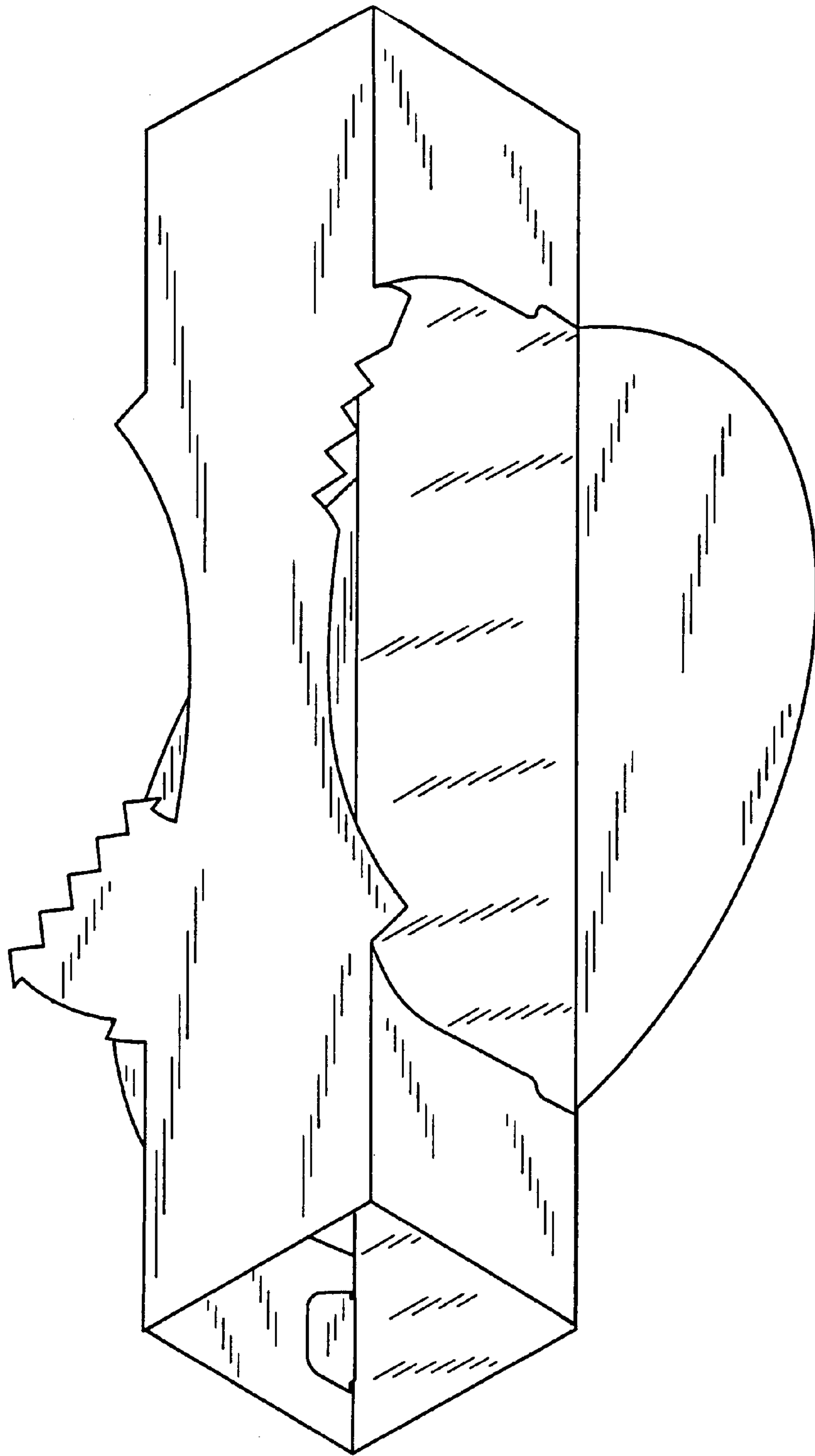
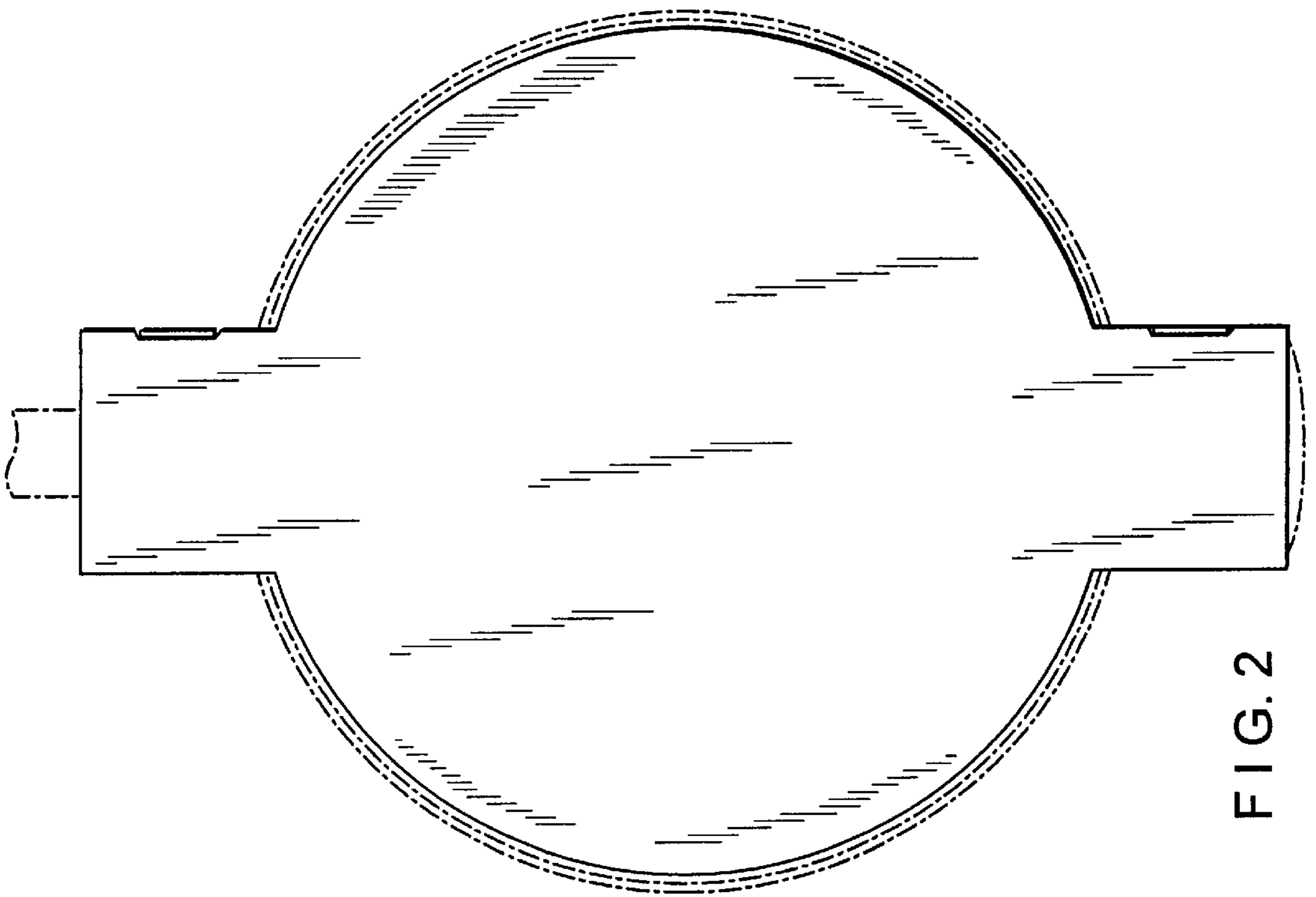
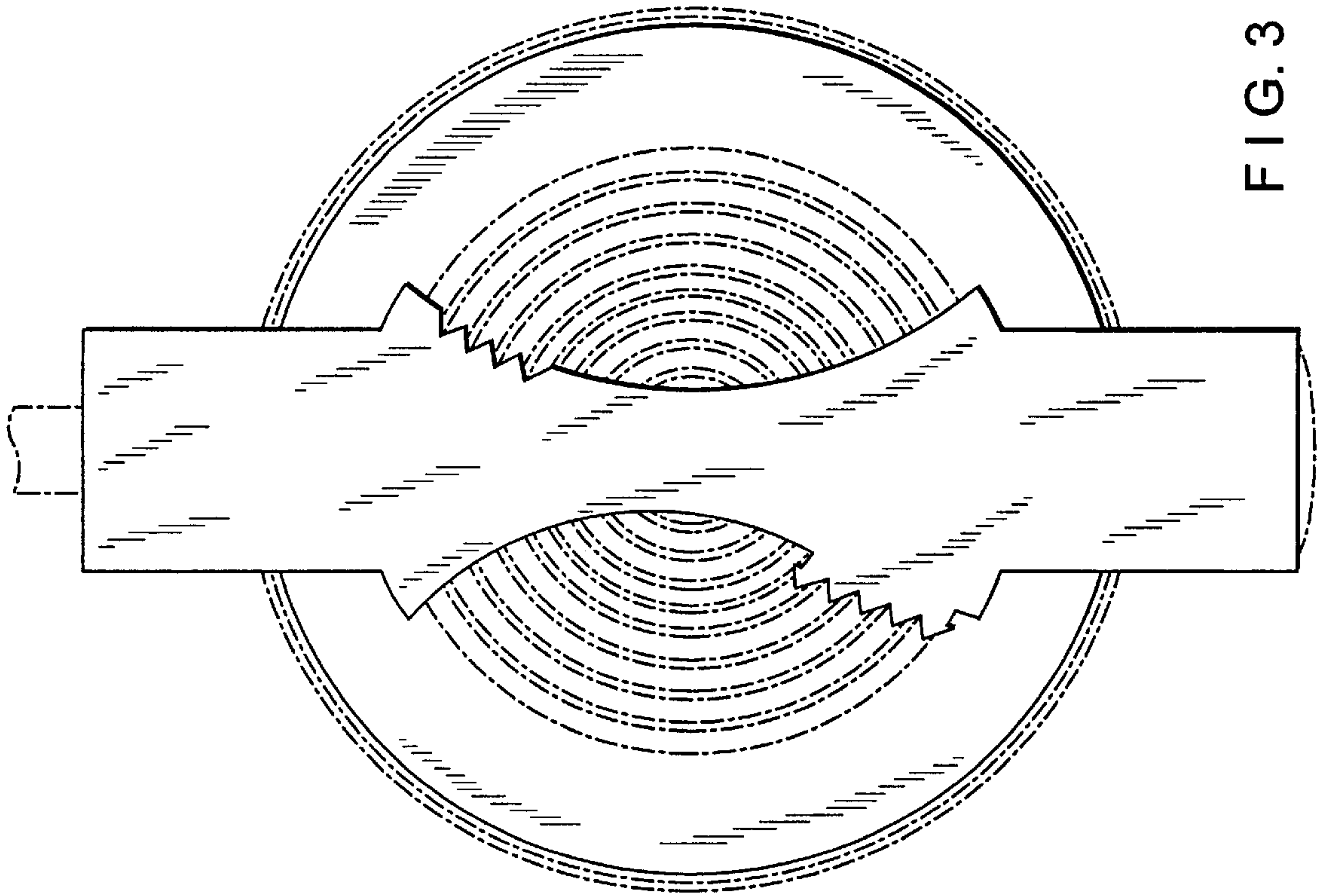

FIG. 1



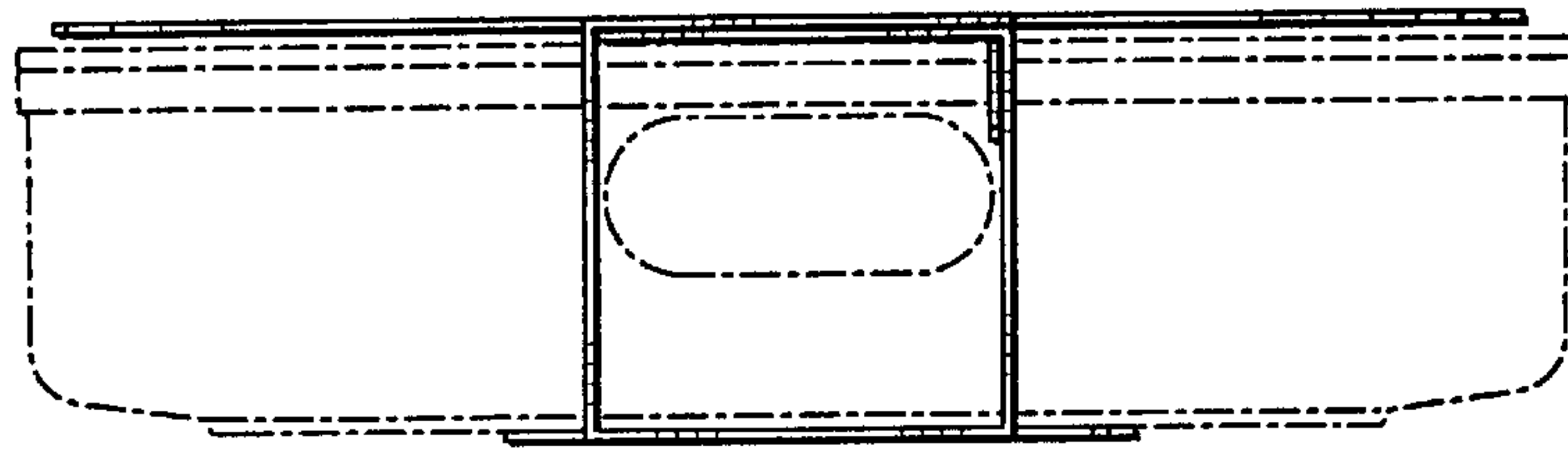

FIG. 4

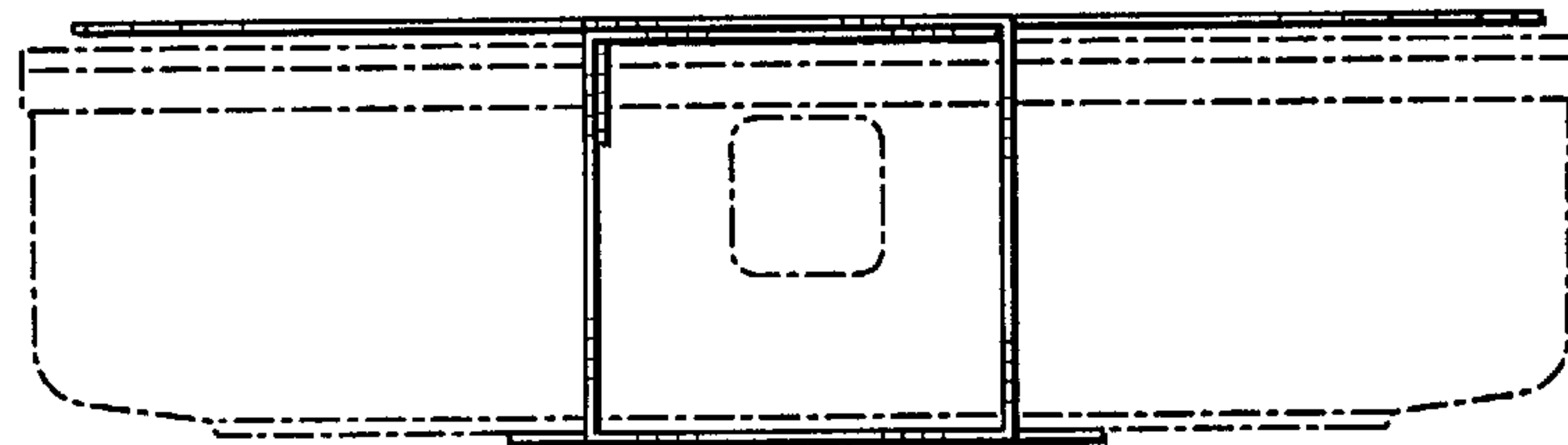

FIG. 5

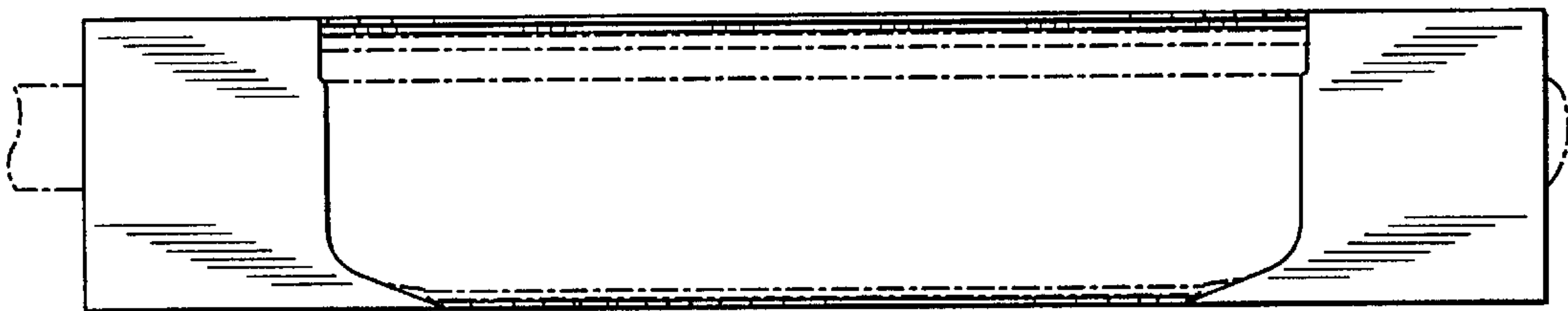

FIG. 6

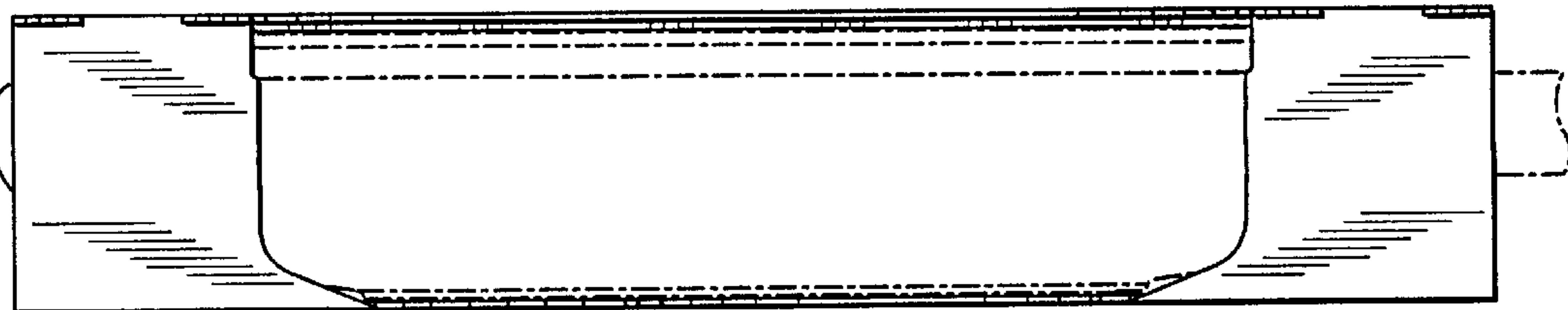

FIG. 7

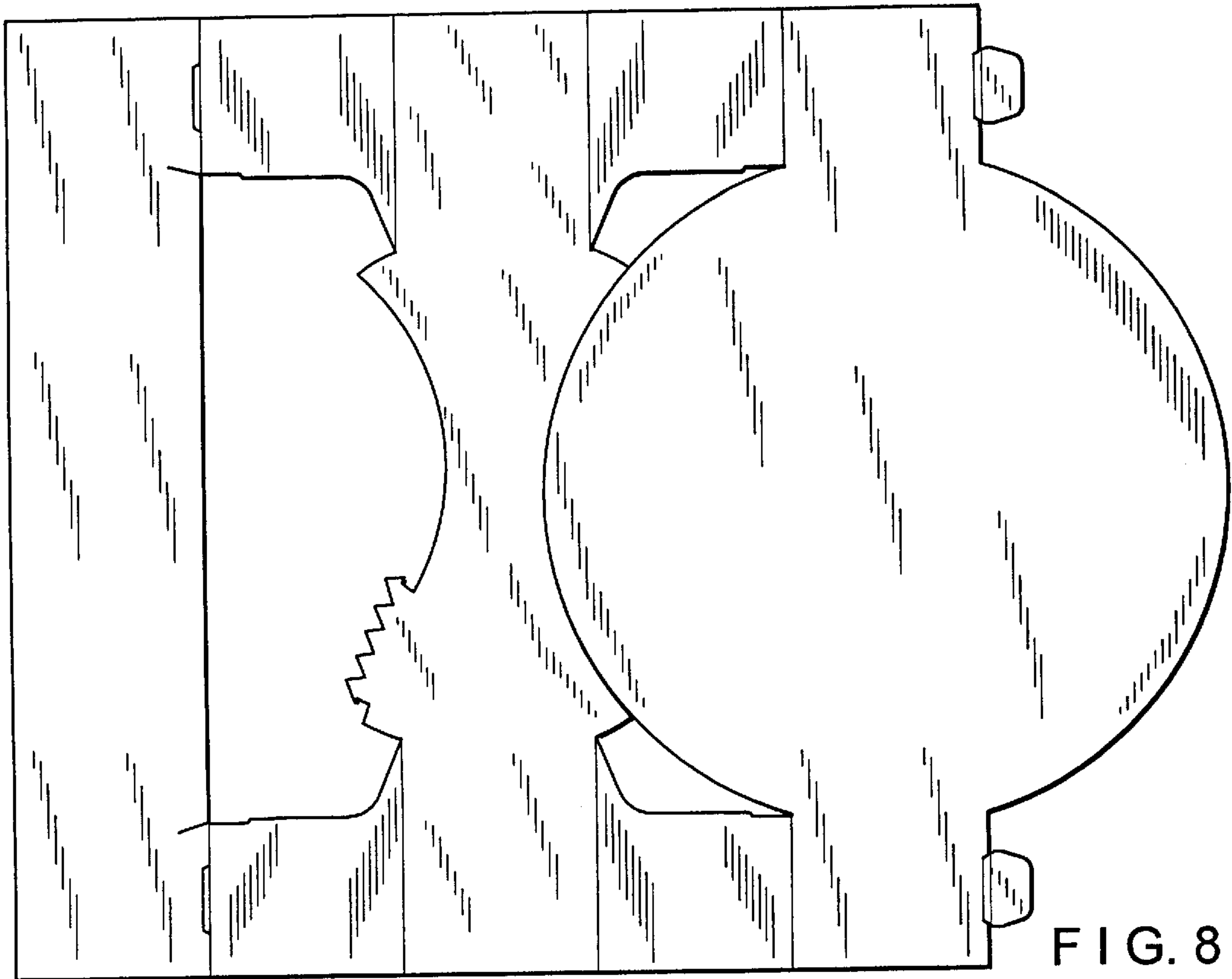

FIG. 8

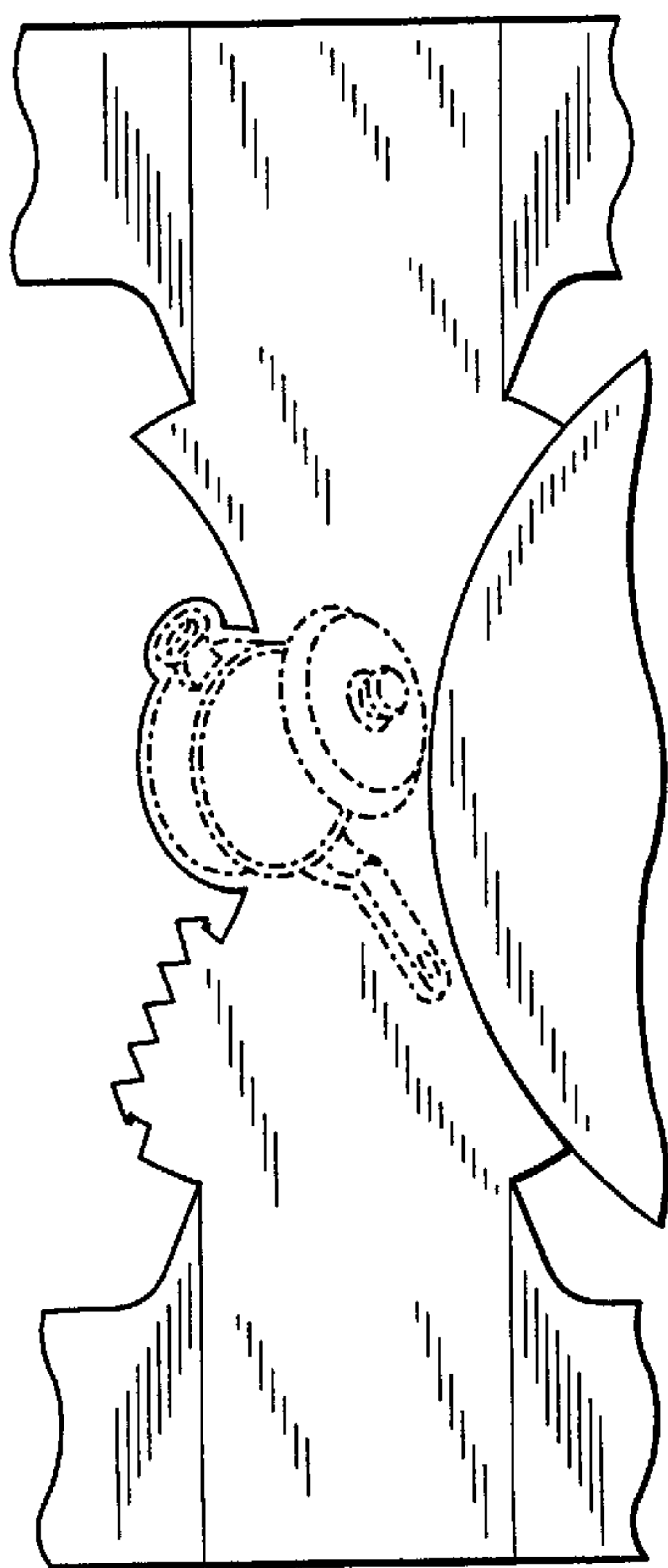

FIG. 9

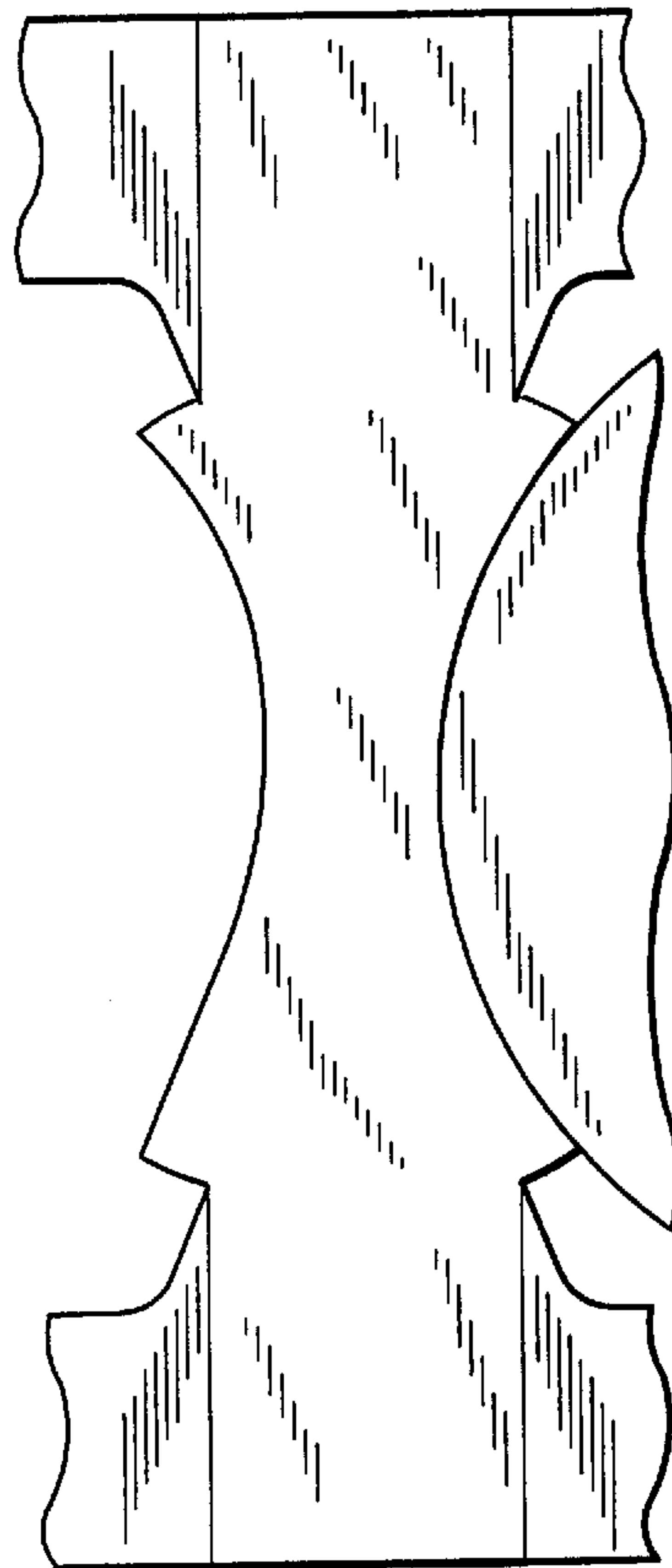

FIG. 10