



US00D411301S

# United States Patent [19] Hampson et al.

[11] **Patent Number: Des. 411,301**  
[45] **Date of Patent: \*\* Jun. 22, 1999**

[54] **FOOT GARMENT**

[75] Inventors: **David Mark Hampson**, South Glamorgan; **Heather Elizabeth Hutflesz**, Gwent; **Rolf Schild**, London, all of United Kingdom

[73] Assignee: **Huntleigh Technology PLC**, Bedfordshire, United Kingdom

[\*\*] Term: **14 Years**

[21] Appl. No.: **29/092,343**

[22] Filed: **Aug. 17, 1998**

### [30] Foreign Application Priority Data

Feb. 17, 1998 [GB] United Kingdom ..... 9803280

[51] **LOC (6) Cl.** ..... **24-04**

[52] **U.S. Cl.** ..... **D24/189**

[58] **Field of Search** ..... D24/192, 190, D24/189, 188; 602/3, 5, 6, 23, 27, 13; 601/149, 151, 152

### [56] References Cited

#### U.S. PATENT DOCUMENTS

1,492,514 4/1924 Jensen .

3,908,642	9/1975	Vinmont .	
4,314,412	2/1982	Anderson et al. .	
4,614,180	9/1986	Gardner et al. .	
4,696,289	9/1987	Gardner et al. .	
5,354,260	10/1994	Cook .....	602/13
5,435,009	7/1995	Schild et al. ....	602/13 X
5,453,082	9/1995	Lamont .....	602/27
5,603,690	2/1997	Barry .....	601/151 X

*Primary Examiner*—Stella Reid  
*Attorney, Agent, or Firm*—Kenyon & Kenyon

### [57] CLAIM

The ornamental design for a foot garment, as shown and described.

### DESCRIPTION

FIG. 1 is a perspective view of a foot garment embodying our new design.  
FIG. 2 is a right side view thereof.  
FIG. 3 is a left side view thereof.  
FIG. 4 is a front side view thereof.  
FIG. 5 is a rear side view thereof.  
FIG. 6 is a top view thereof.  
FIG. 7 is a bottom view thereof.  
FIG. 8 is a view of the inside thereof; and,  
FIG. 9 is a view of the outside thereof.

**1 Claim, 8 Drawing Sheets**

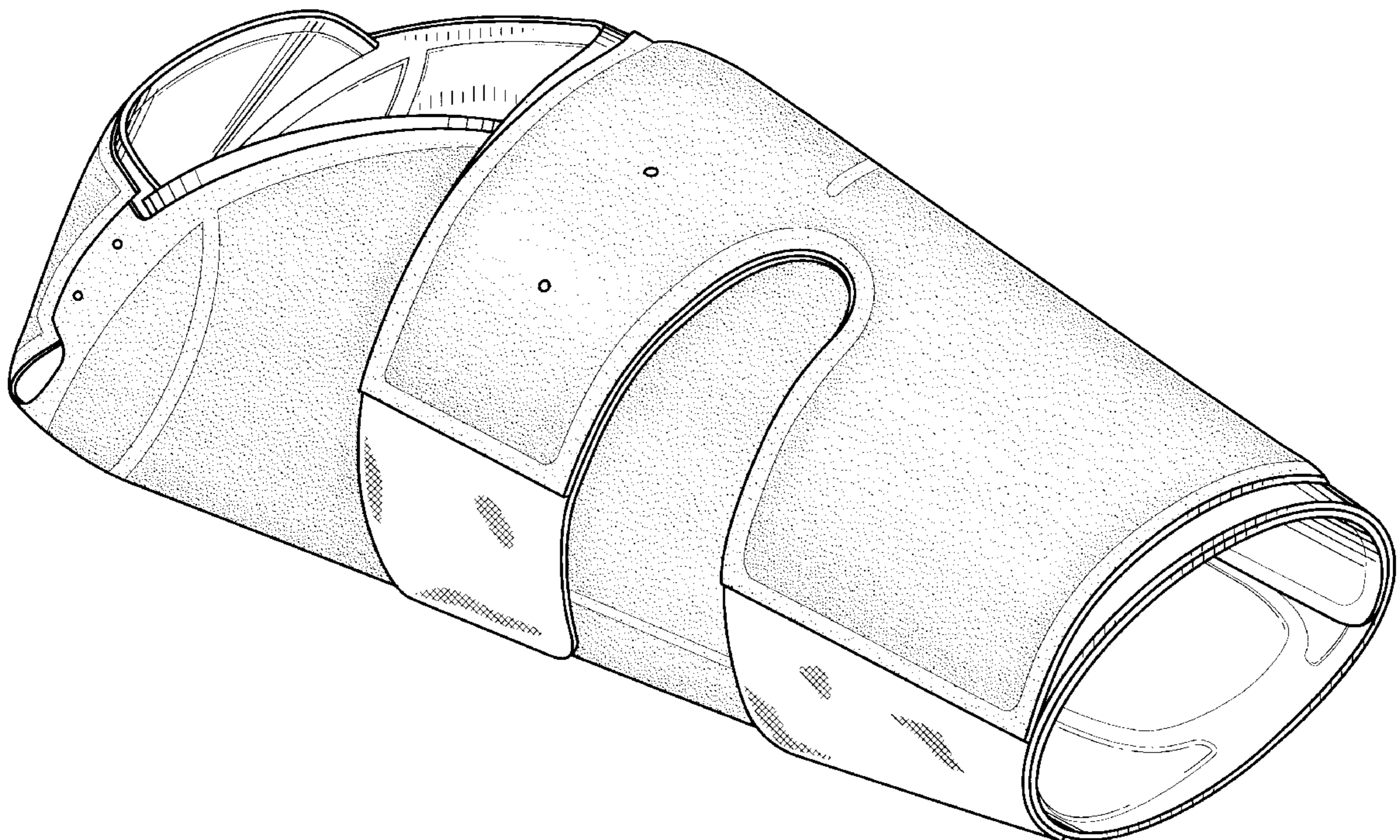

FIG. 1

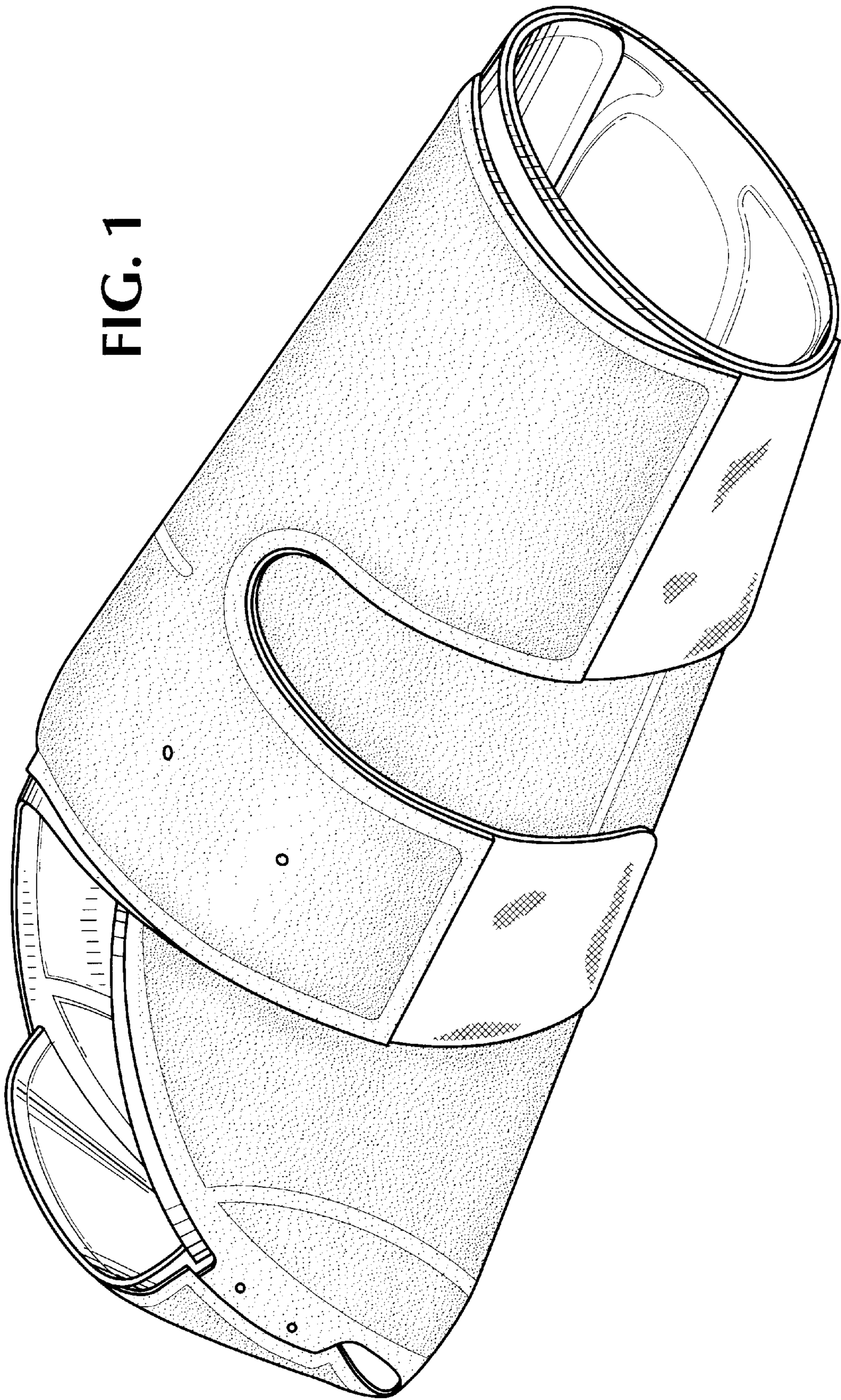

FIG. 2

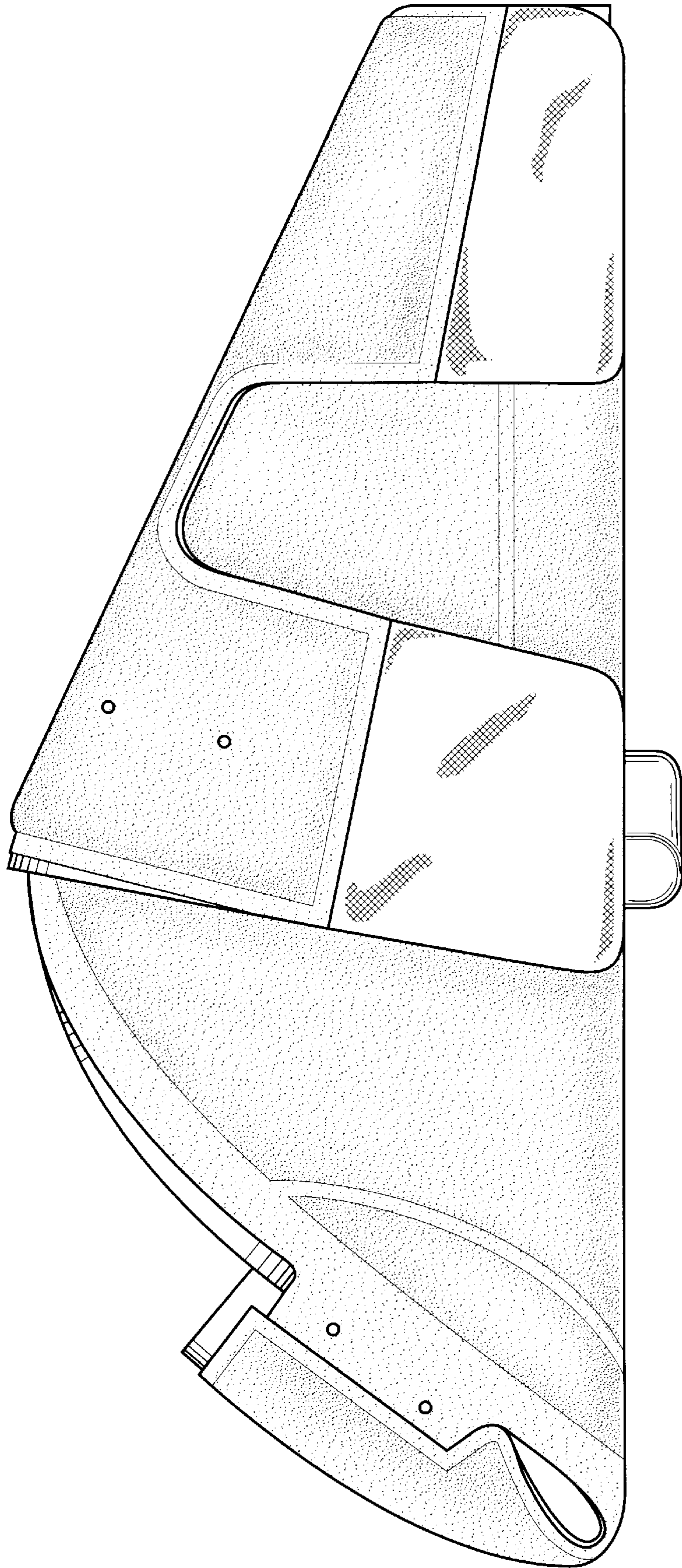
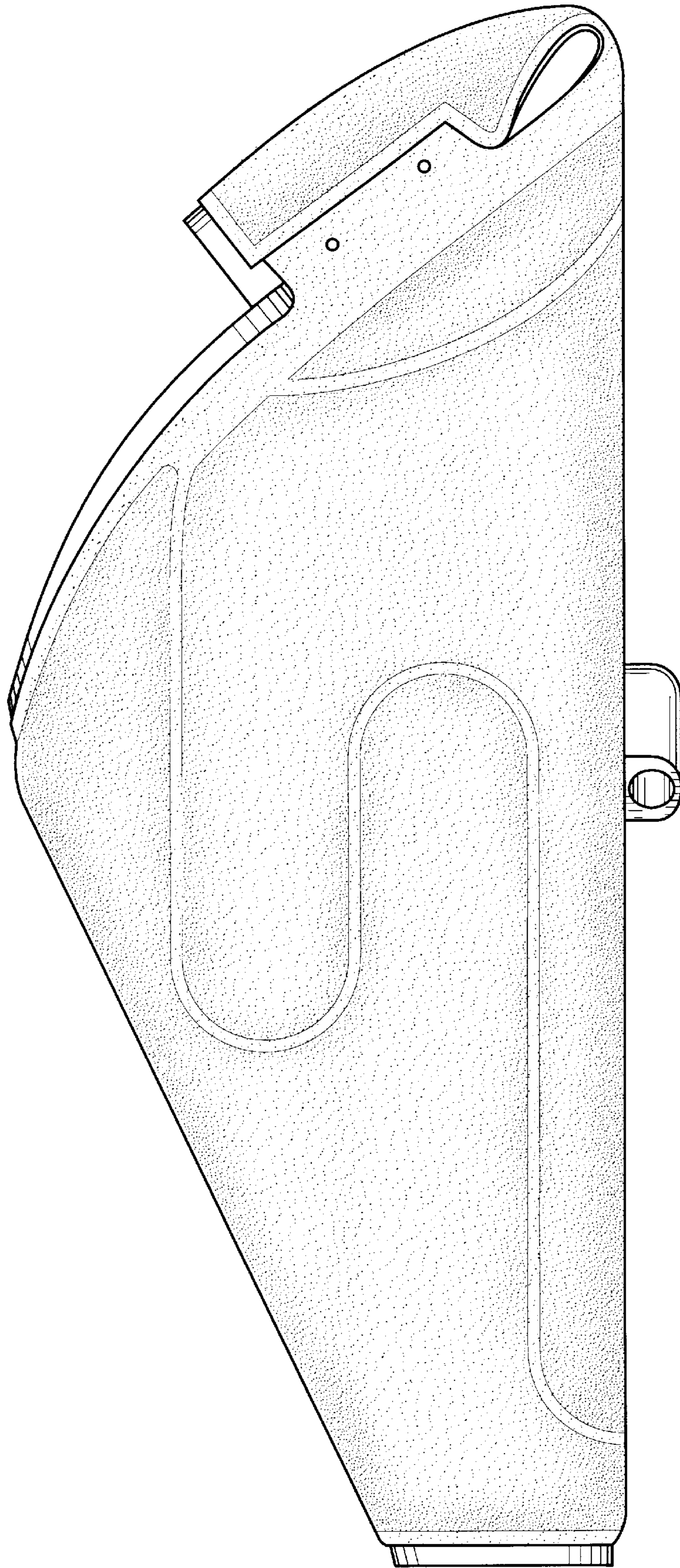
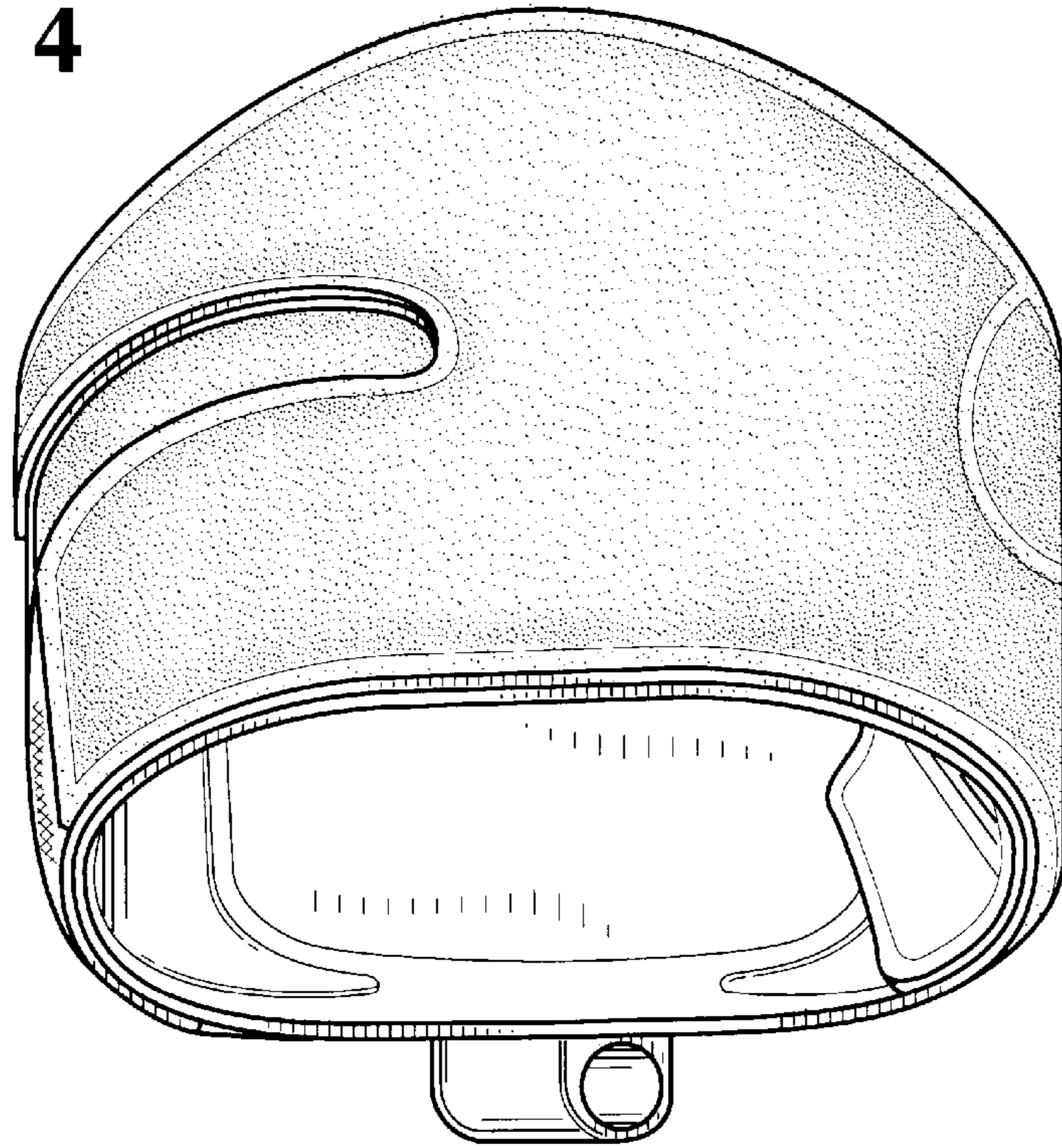

FIG. 3



**FIG. 4**



**FIG. 5**

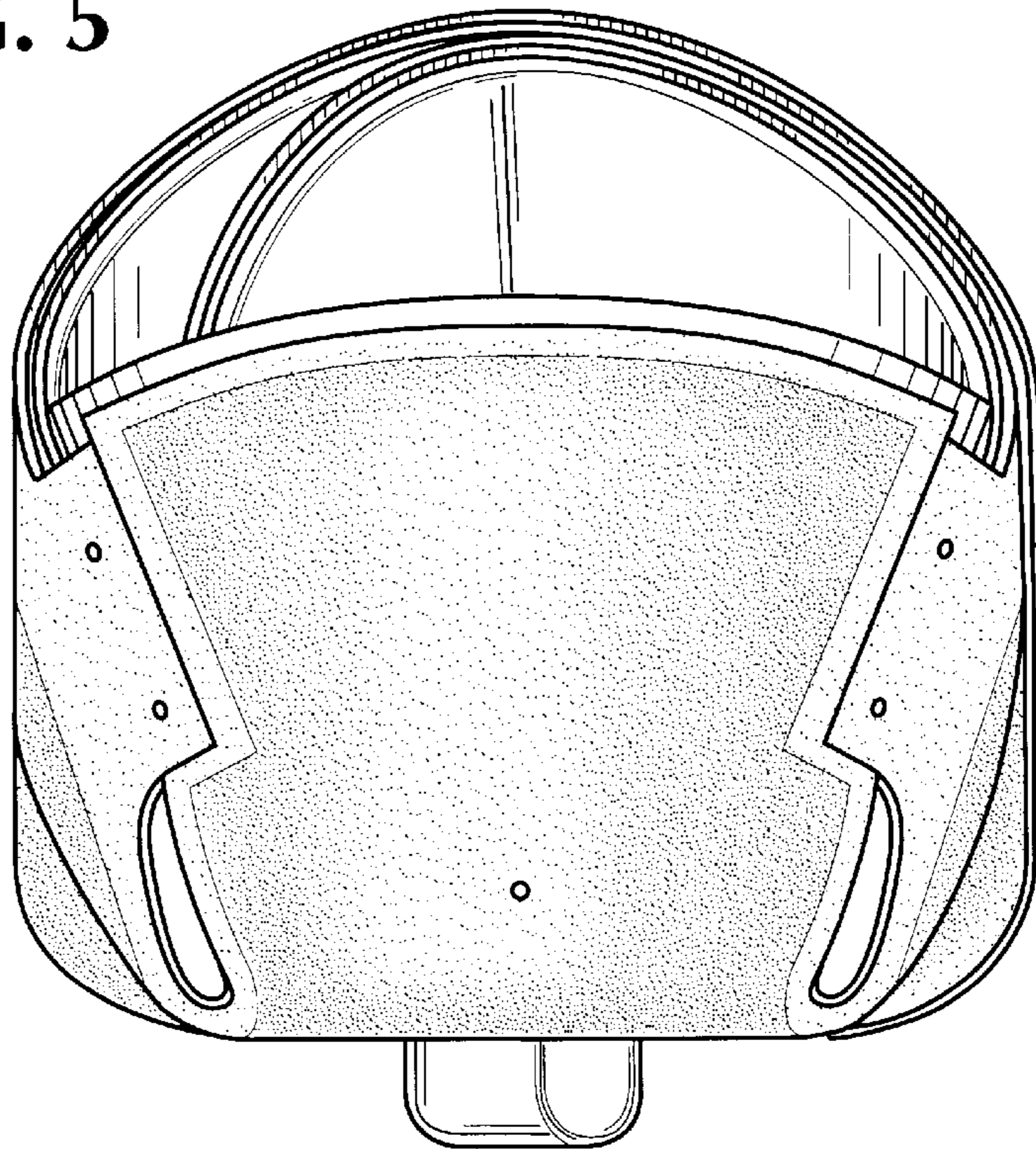

FIG. 6

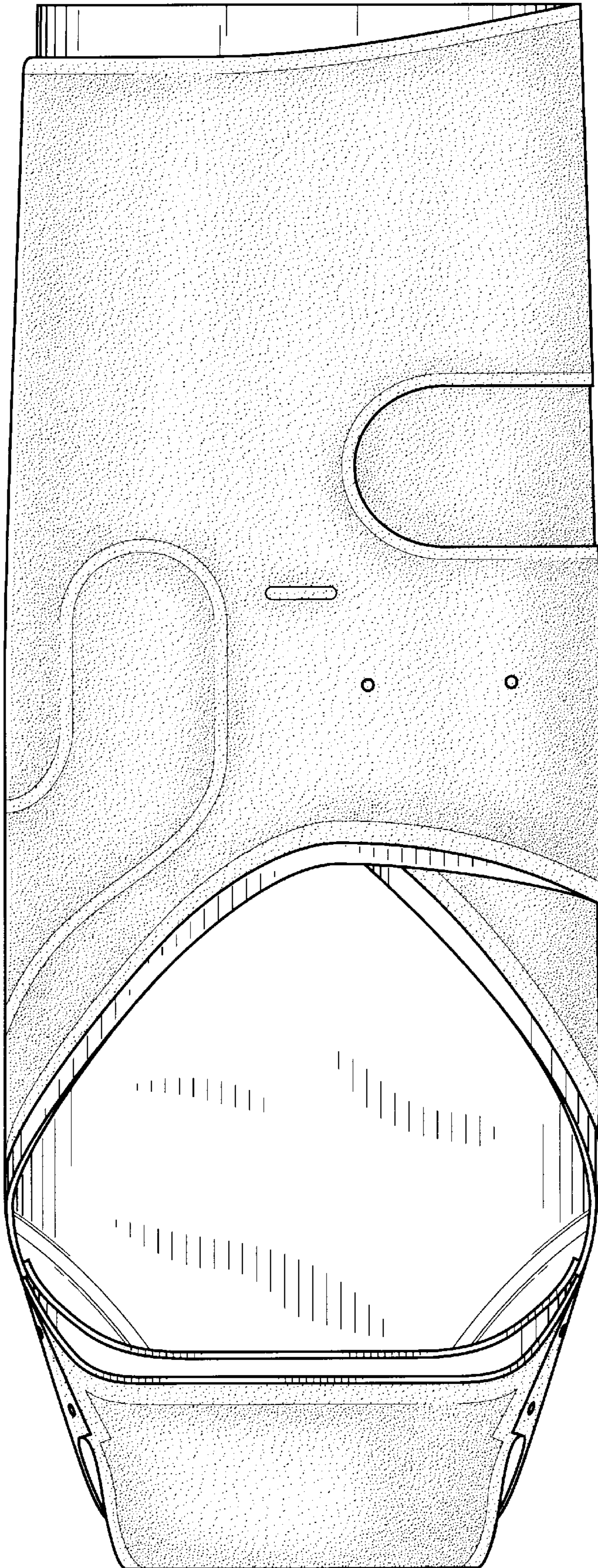

FIG. 7

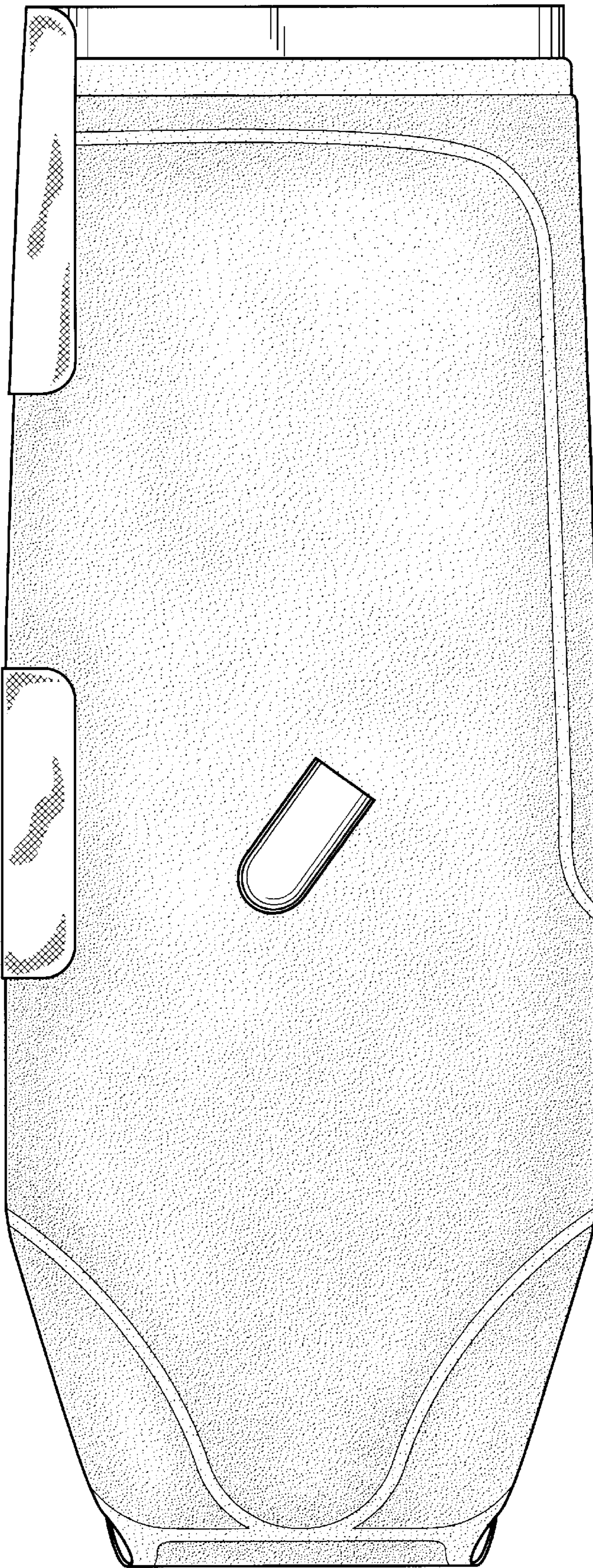
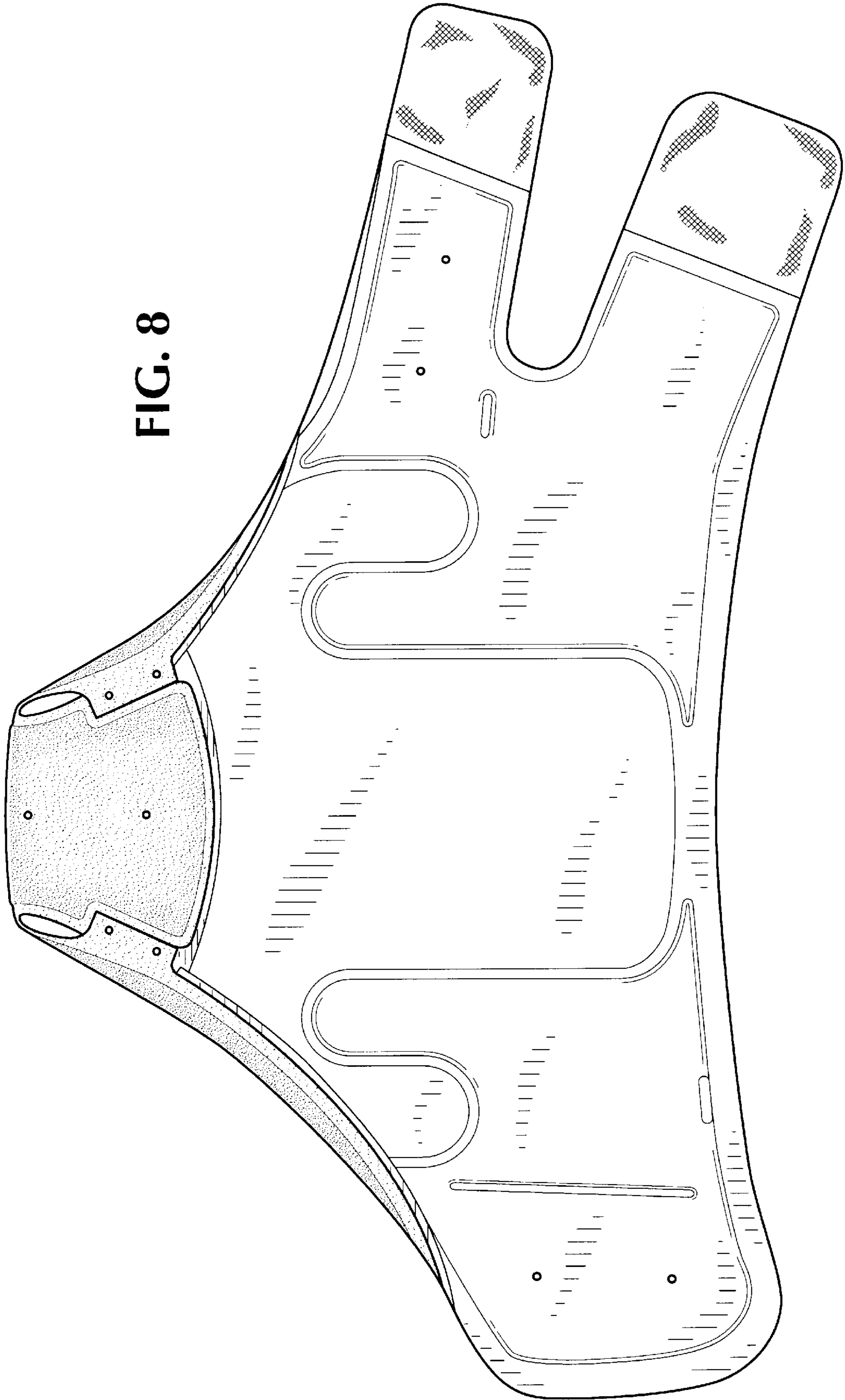

FIG. 8





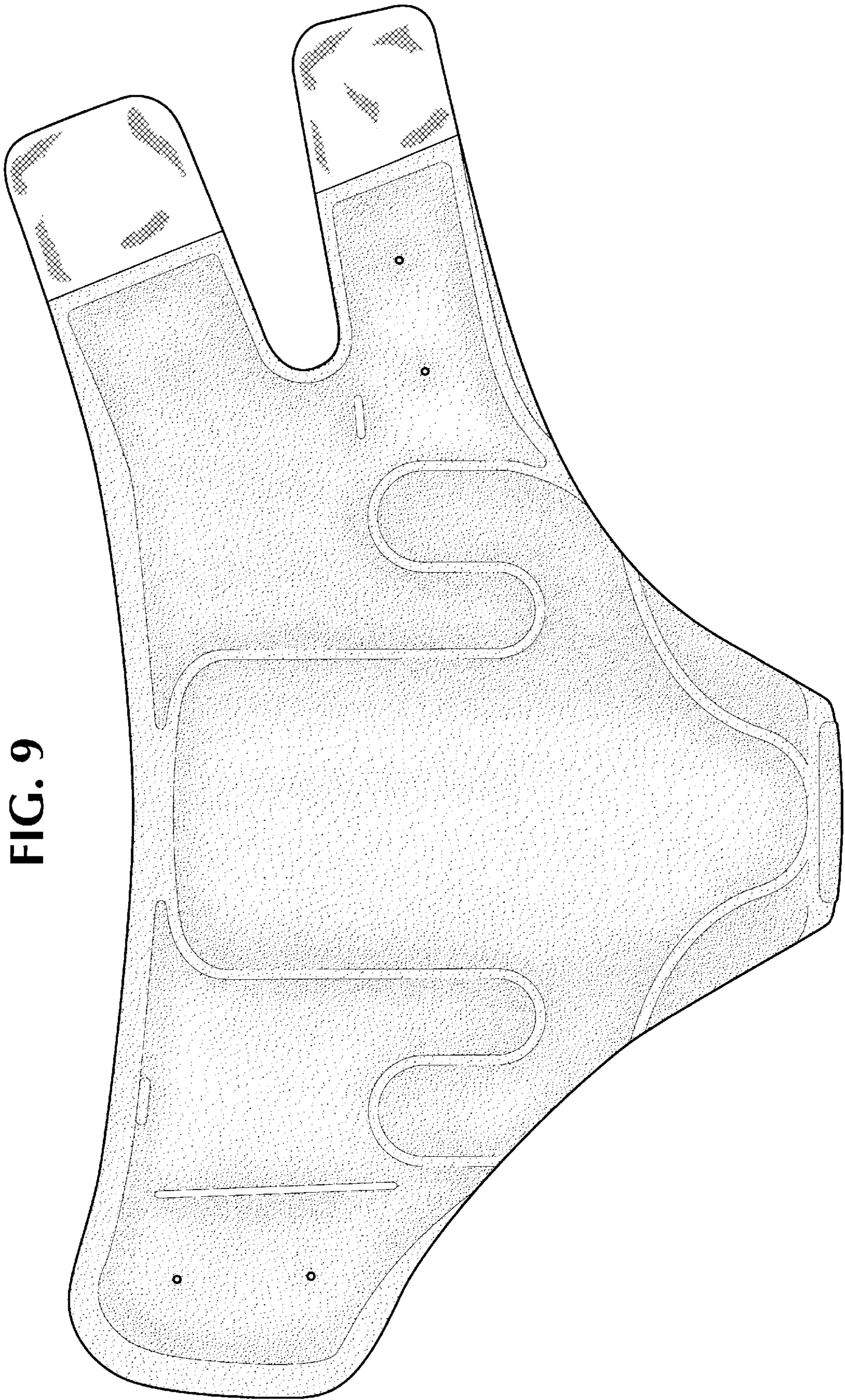

FIG. 9