



US00D411065S

# United States Patent [19] Davis

[11] **Patent Number: Des. 411,065**  
[45] **Date of Patent: \*\* Jun. 15, 1999**

[54] **FOLDING WALL-MOUNTED CHILD SEAT**

2,965,153 12/1960 Purcell .  
3,873,151 3/1975 Morris et al. .  
4,723,493 2/1988 Siani et al. .

[76] Inventor: **Darrell Davis**, 21735 Orange Ave.,  
Castro Valley, Calif. 94546

### OTHER PUBLICATIONS

Brochure distributed by American Inventors Corporation  
approximately during Oct. 1991.

[\*\*] Term: **14 Years**

*Primary Examiner*—Brian N. Vinson

[21] Appl. No.: **29/022,164**

[22] Filed: **May 2, 1994**

### [57] CLAIM

### Related U.S. Application Data

The ornamental design for a folding wall-mounted child  
seat, as shown and described.

[62] Division of application No. 07/745,101, Aug. 14, 1991,  
abandoned.

### DESCRIPTION

[51] **LOC (6) Cl.** ..... **08-08**

[52] **U.S. Cl.** ..... **D6/555**

[58] **Field of Search** ..... D6/553, 555, 567,  
D6/574; 211/13, 34-35, 65, 69.1, 70.6,  
70.7

FIG. 1 is a front elevational view of a folding wall-mounted  
child seat showing my new design;  
FIG. 2 is a rear elevational view thereof;  
FIG. 3 is a left side elevational view thereof;  
FIG. 4 is a right side elevational view thereof;  
FIG. 5 is a top plan view thereof;  
FIG. 6 is a bottom plan view thereof; and,  
FIG. 7 is a perspective view thereof in an open position, the  
broken line showing of the door for illustrative purposes  
only and forming no part of the claimed design.

### [56] References Cited

#### U.S. PATENT DOCUMENTS

D. 271,731 12/1983 Chamberlain et al. .  
D. 302,088 7/1989 Burt ..... D6/555  
D. 326,384 5/1992 Burt et al. .... D6/555  
2,807,512 9/1957 Blink .

**1 Claim, 4 Drawing Sheets**

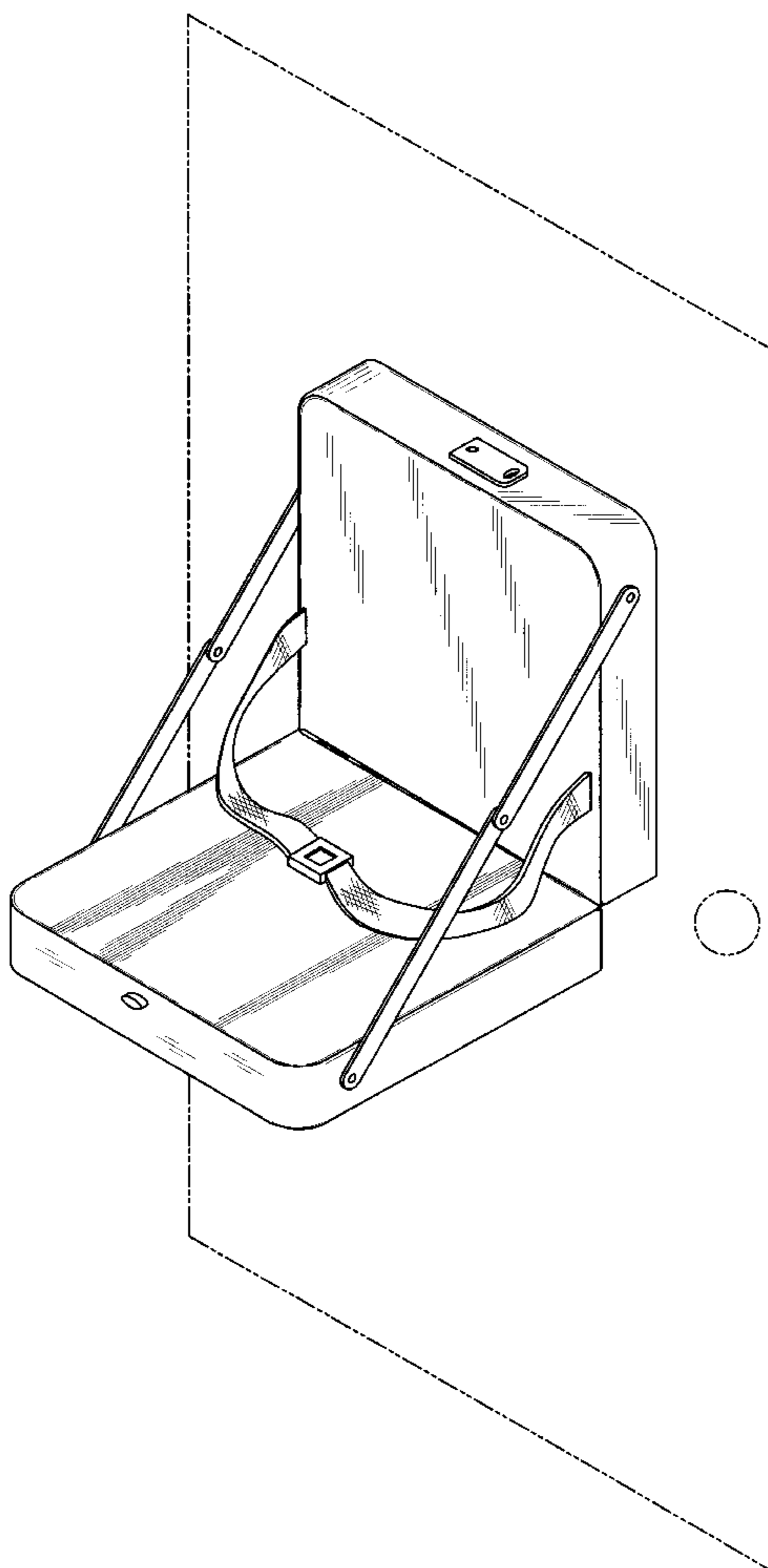

FIG. 1

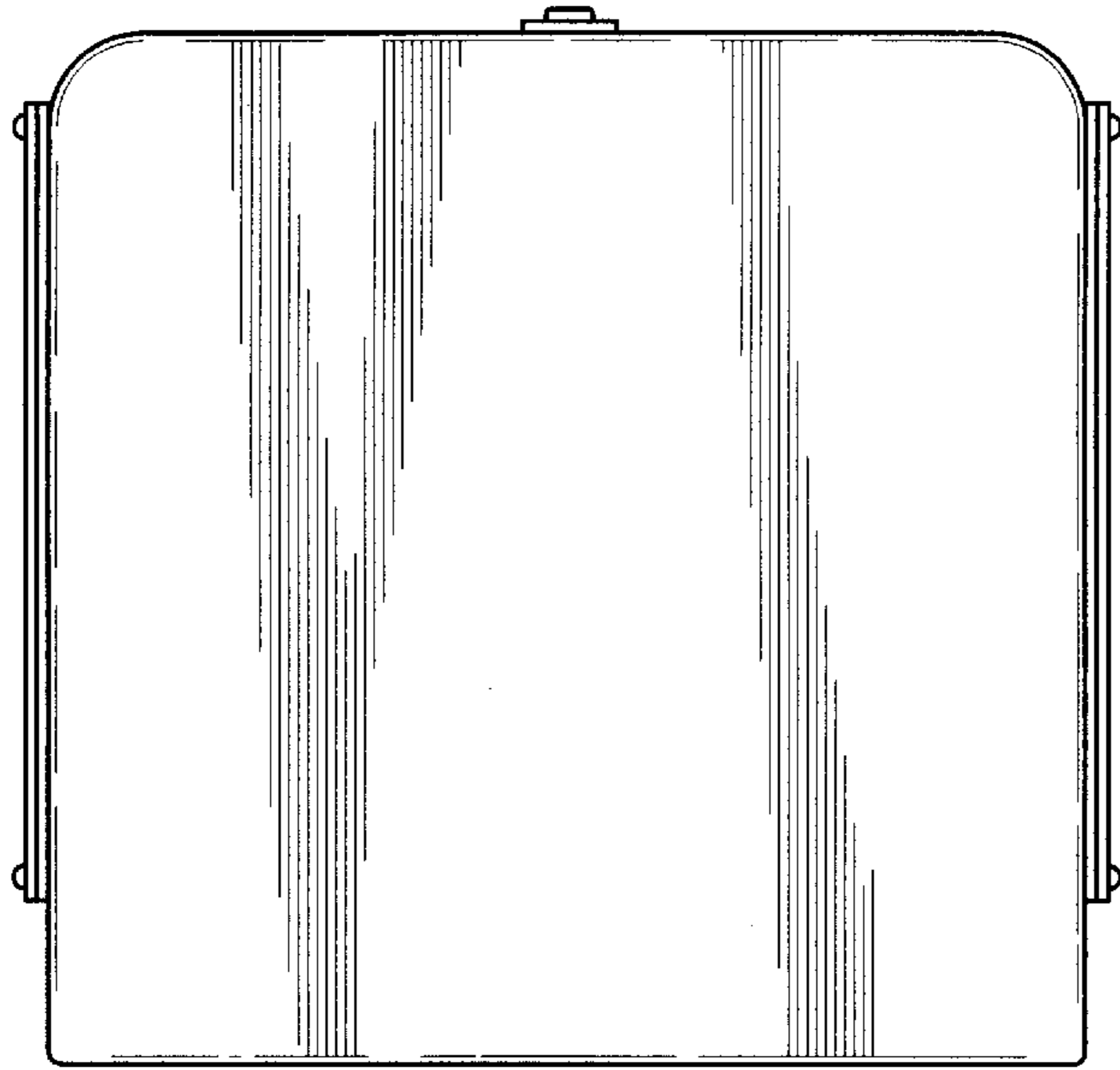

FIG. 2

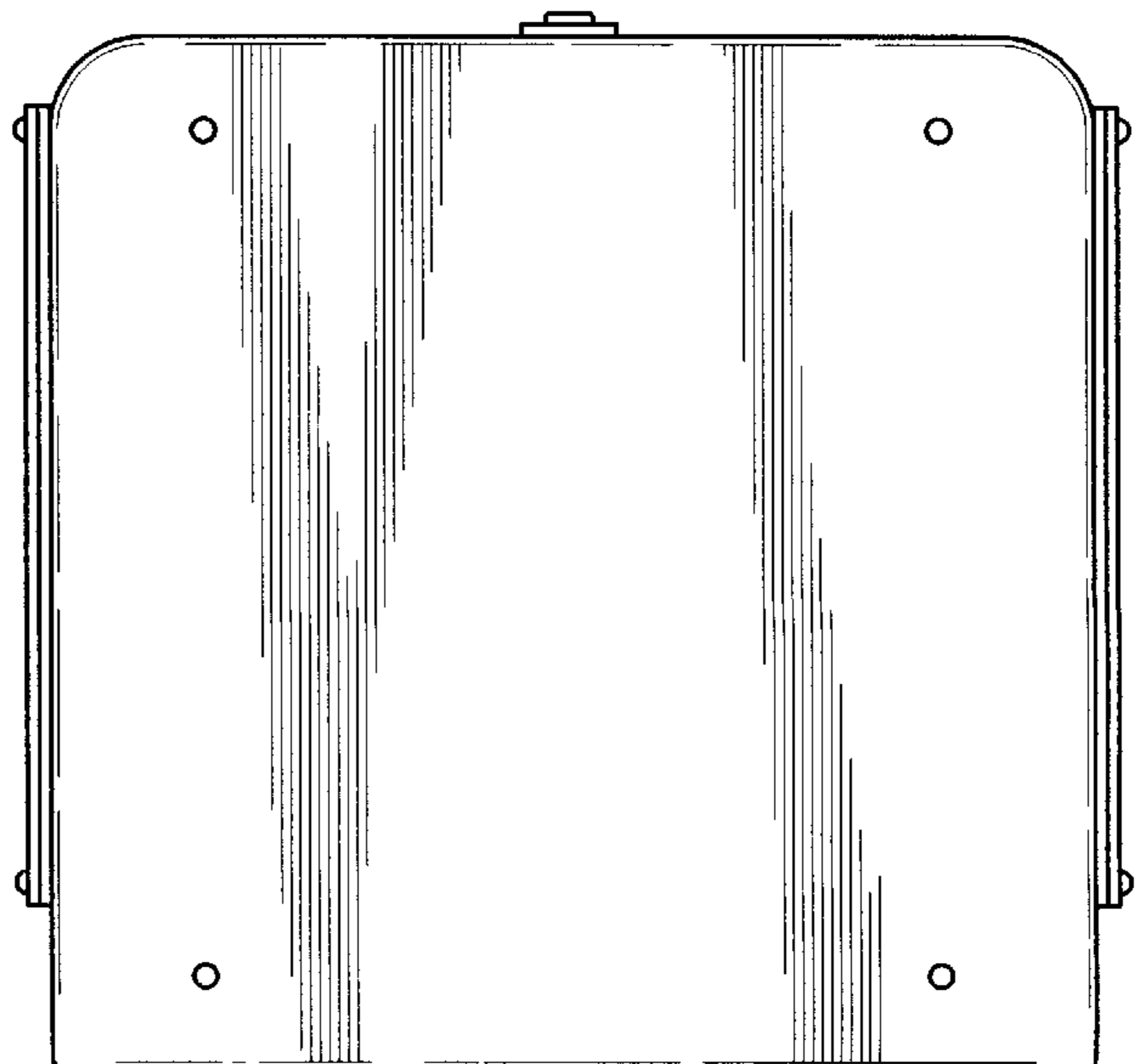

FIG. 3

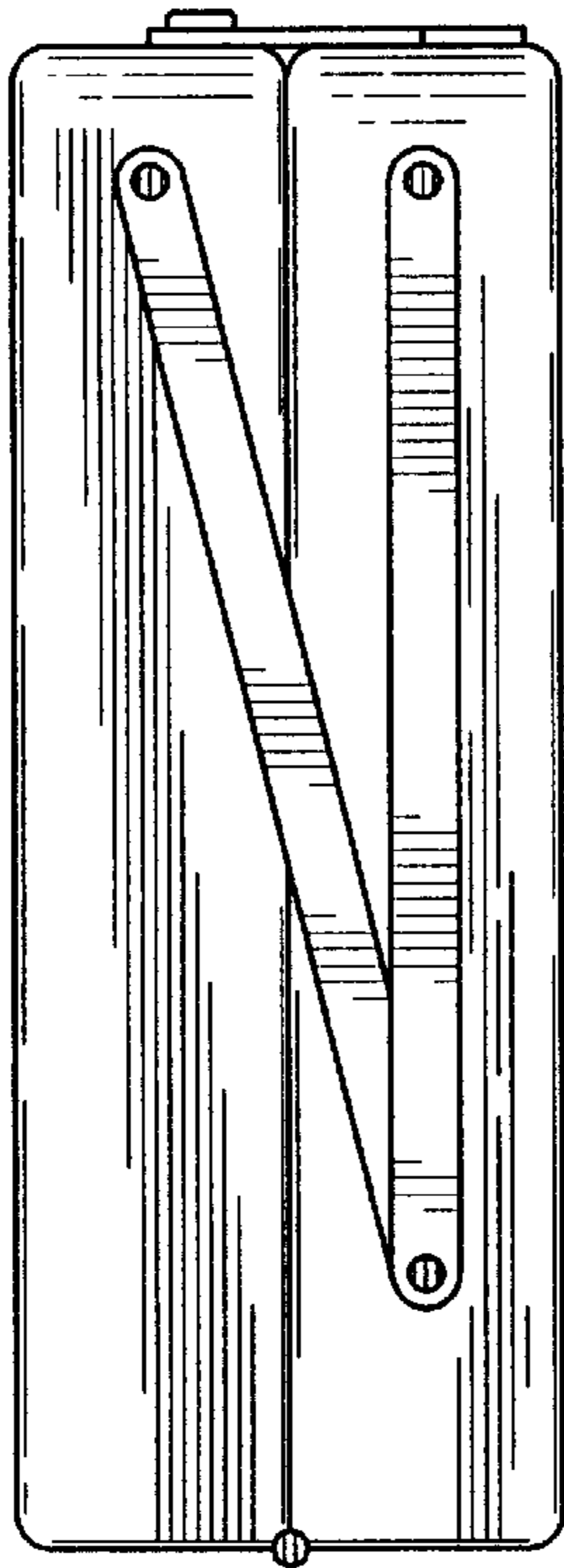
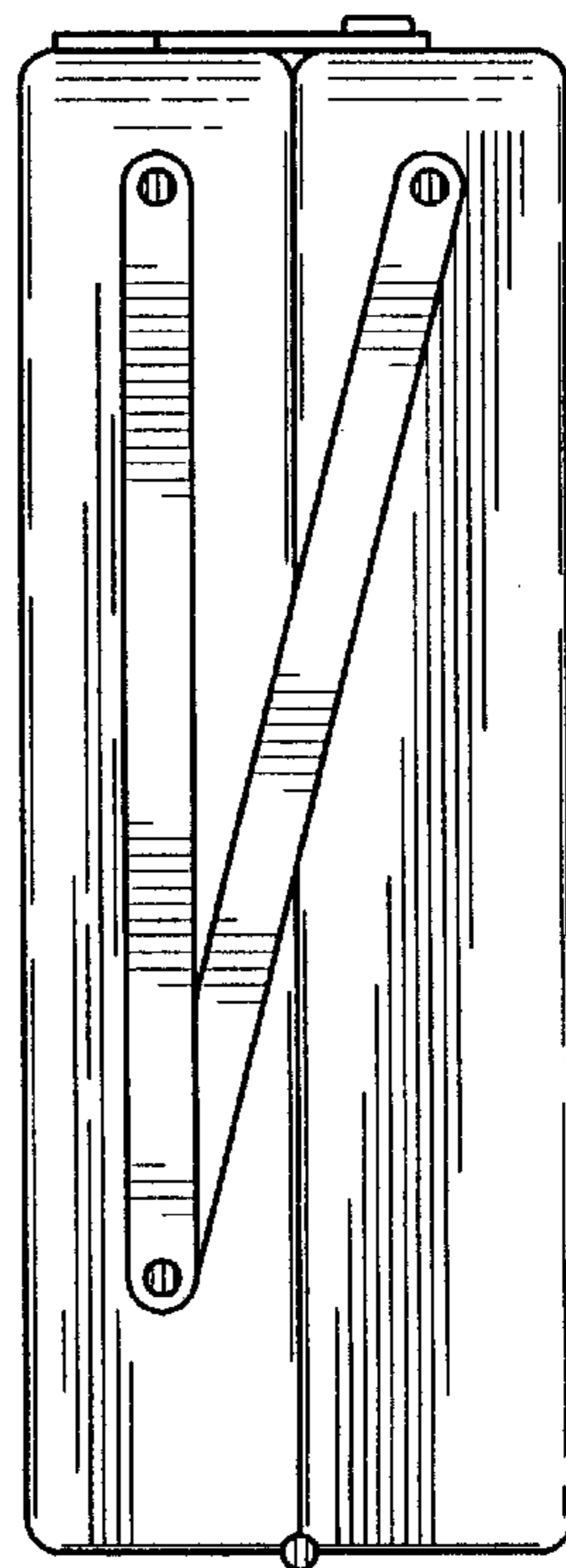
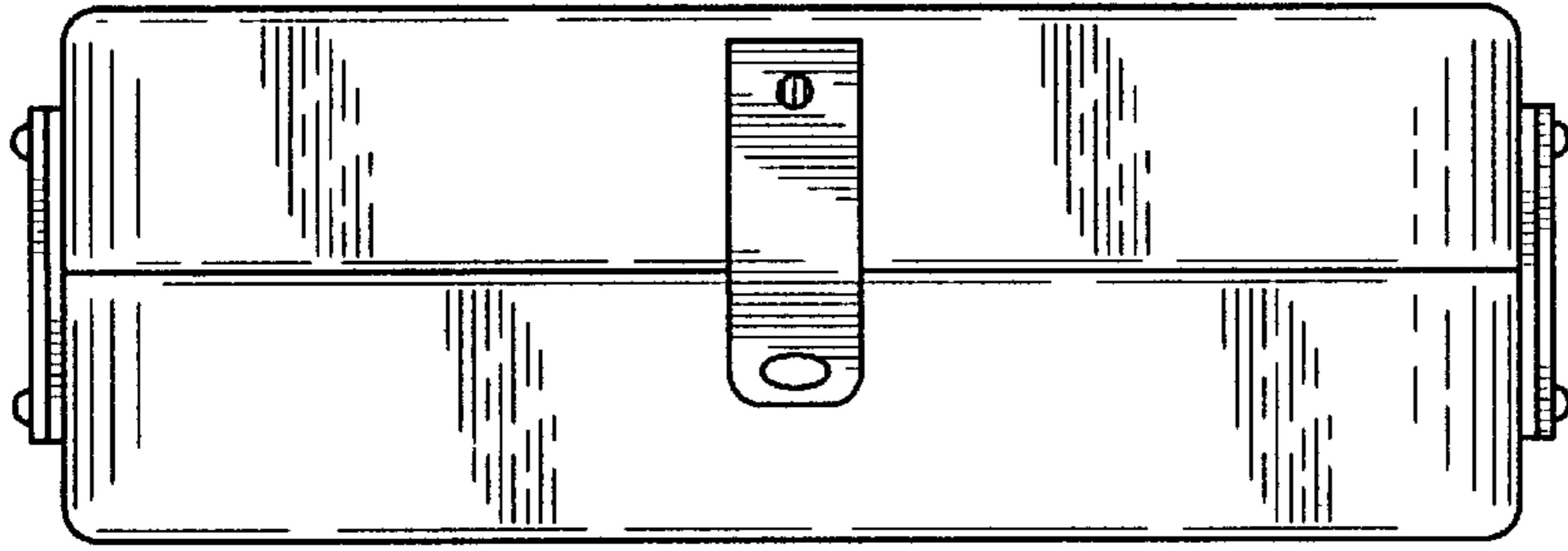

FIG. 4



*FIG. 5*



*FIG. 6*

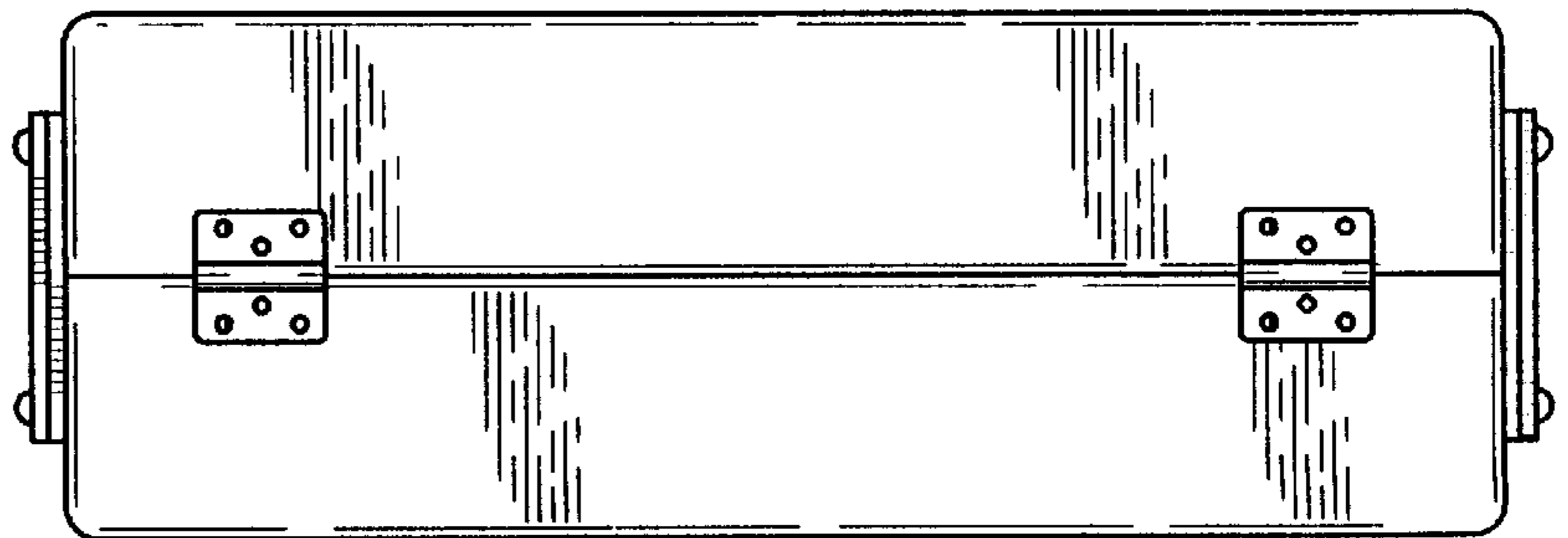

FIG. 7

