



US00D411030S

**United States Patent** [19]  
**Chen**

[11] **Patent Number: Des. 411,030**

[45] **Date of Patent: \*\* Jun. 15, 1999**

[54] **VANITY LIGHT**

[76] **Inventor: Tusng-Wen Chen**, No. 6, Tinghu 2nd St., Kweishan Hsiang, Taoyuan Hsien, Taiwan

[\*\*] **Term: 14 Years**

[21] **Appl. No.: 29/084,952**

[22] **Filed: Mar. 13, 1998**

[51] **LOC (6) Cl. .... 26-05**

[52] **U.S. Cl. .... D26/87**

[58] **Field of Search** ..... D26/87, 92, 85,  
D26/142, 145, 155; 362/147, 432, 310,  
311

[56] **References Cited**

**U.S. PATENT DOCUMENTS**

- D. 383,238 9/1997 Chen ..... D26/87
- D. 397,487 8/1998 Hsu ..... D26/87

**OTHER PUBLICATIONS**

Murray Feiss lighting catalog, p. 140, lamp fixture #VS55033, Mar. 1995.

Progress lighting catalog, p. 119, wall lamp #P31113, 1988.

*Primary Examiner*—Susan J. Lucas

*Attorney, Agent, or Firm*—Rosenberg, Klein & Bilker

[57] **CLAIM**

The ornamental design for a vanity light, as shown and described.

**DESCRIPTION**

FIG. 1 is a perspective view of a vanity light showing my new design;

FIG. 2 is a top plan view thereof;

FIG. 3 is a bottom plan view thereof;

FIG. 4 is a front elevational view thereof;

FIG. 5 is a rear elevational view thereof;

FIG. 6 is a left side elevational view thereof; and,

FIG. 7 is a right side elevational view thereof.

**1 Claim, 4 Drawing Sheets**

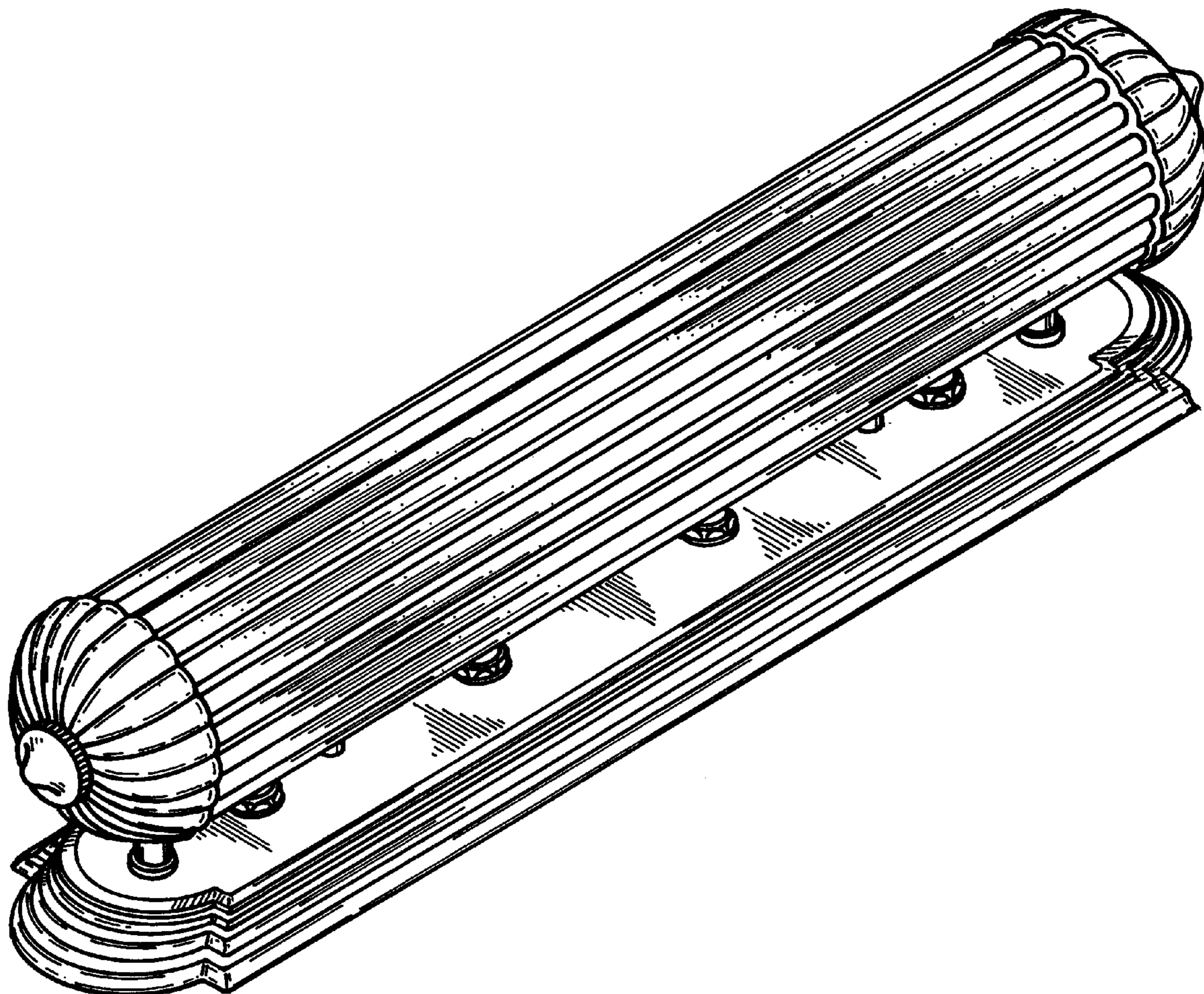

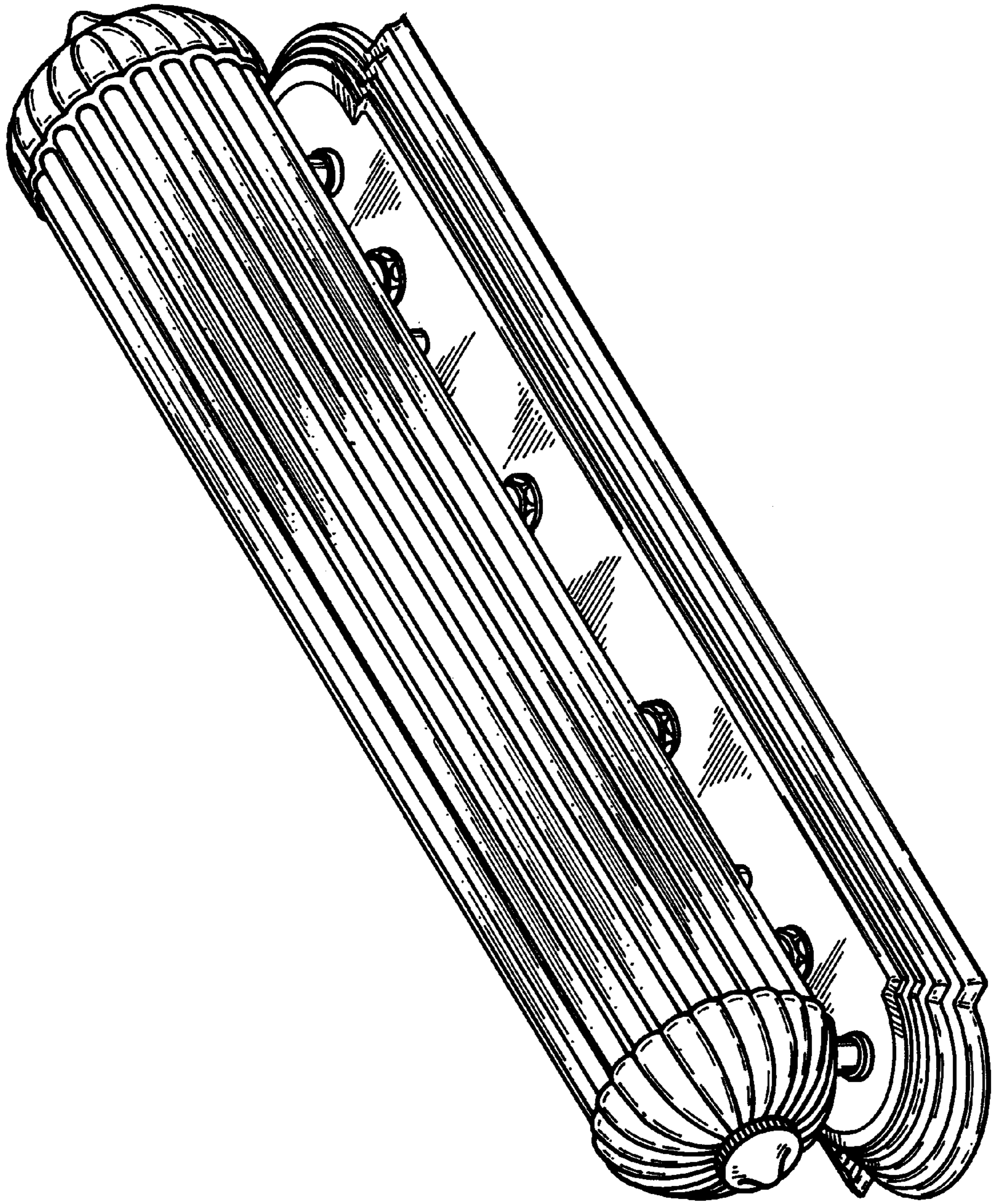

FIG.1

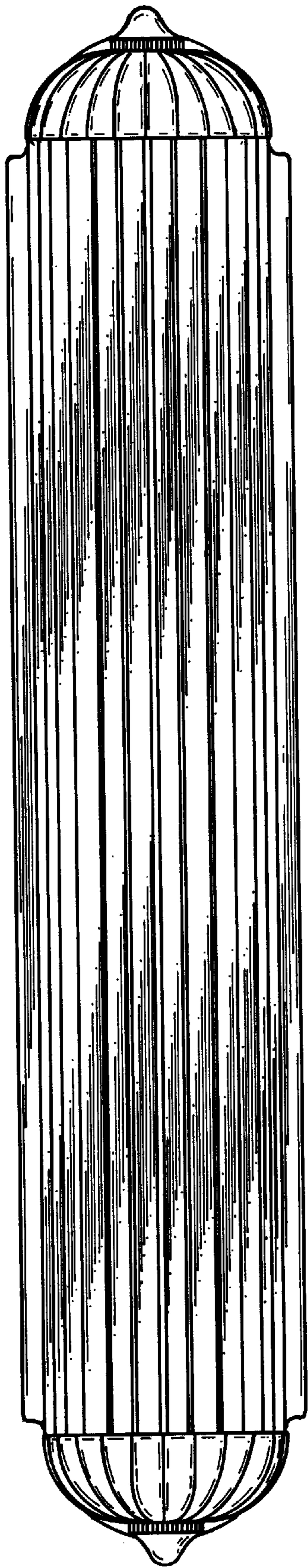

FIG. 2

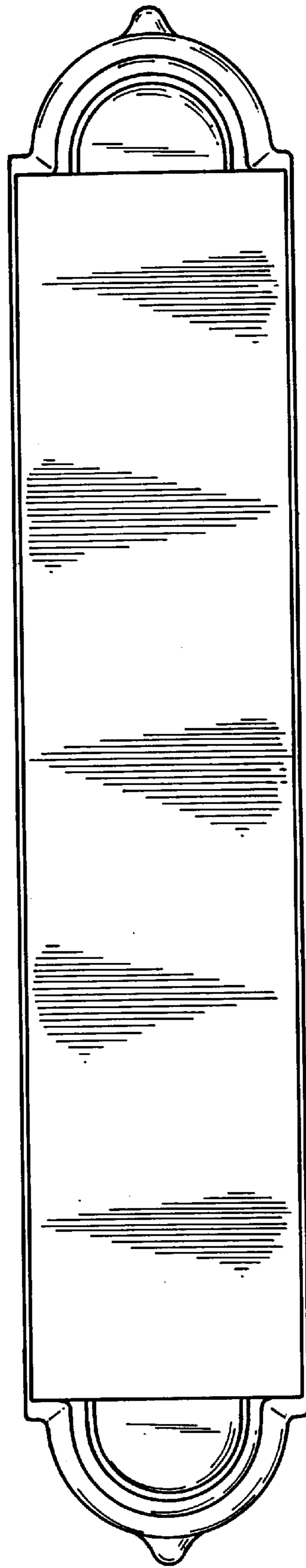

FIG. 3

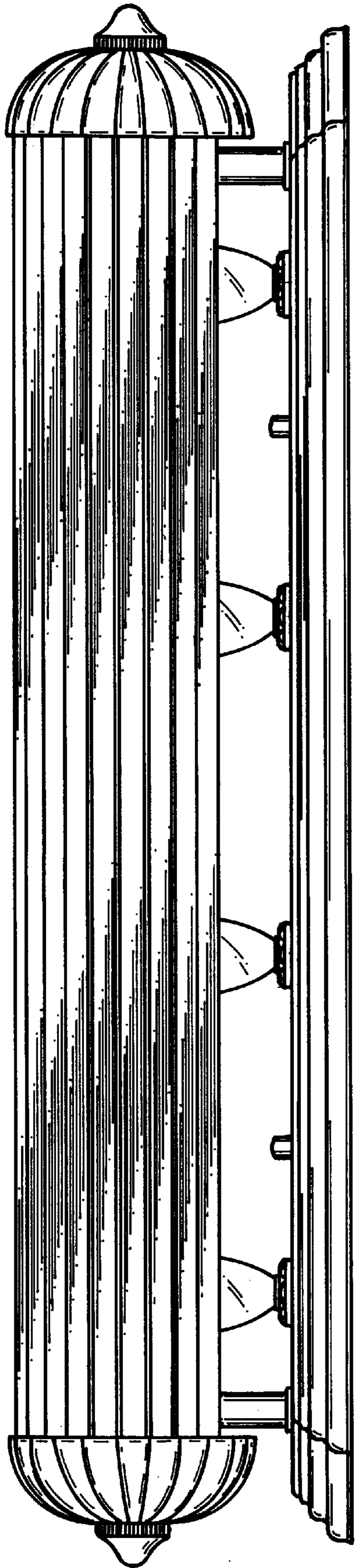

FIG. 4

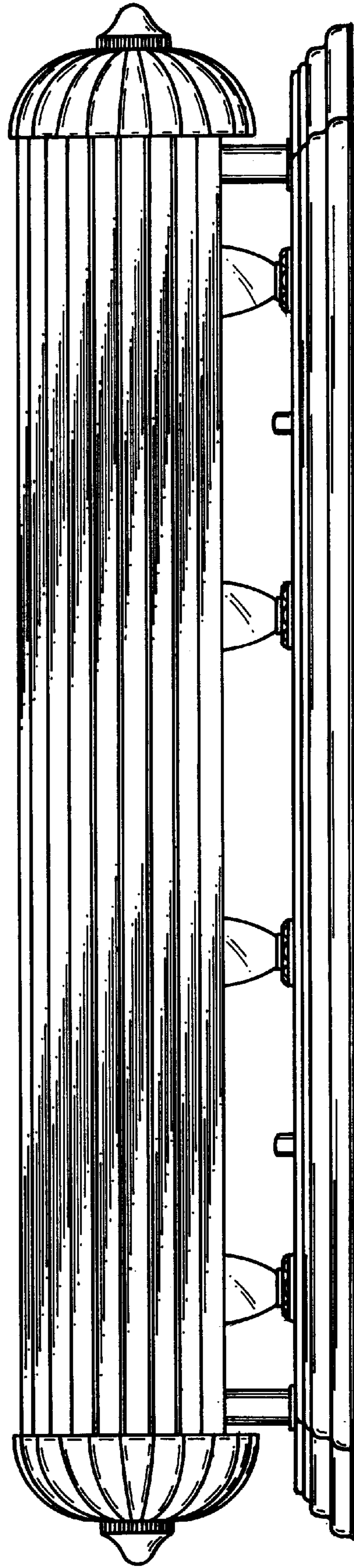

FIG. 5

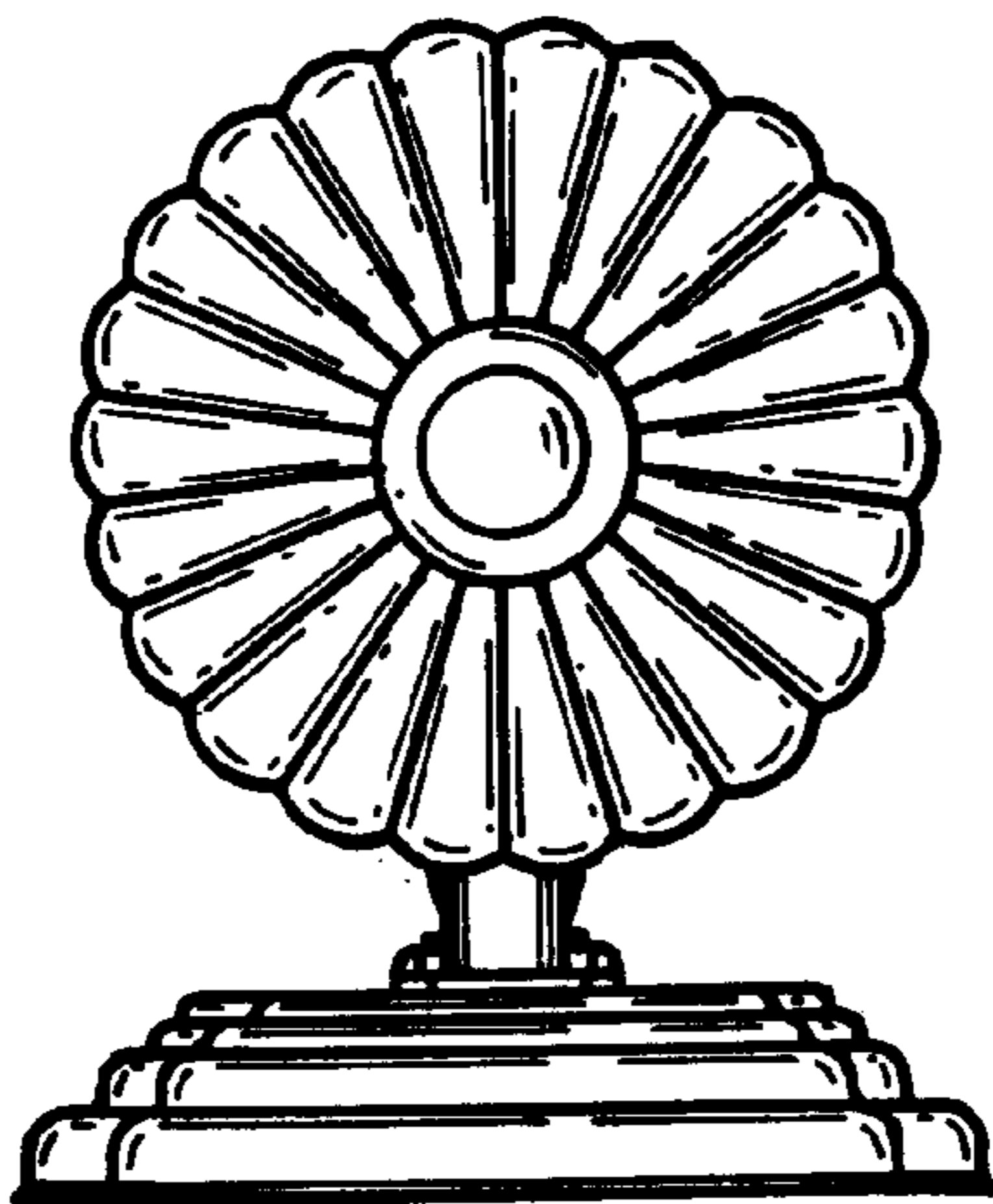

FIG. 6

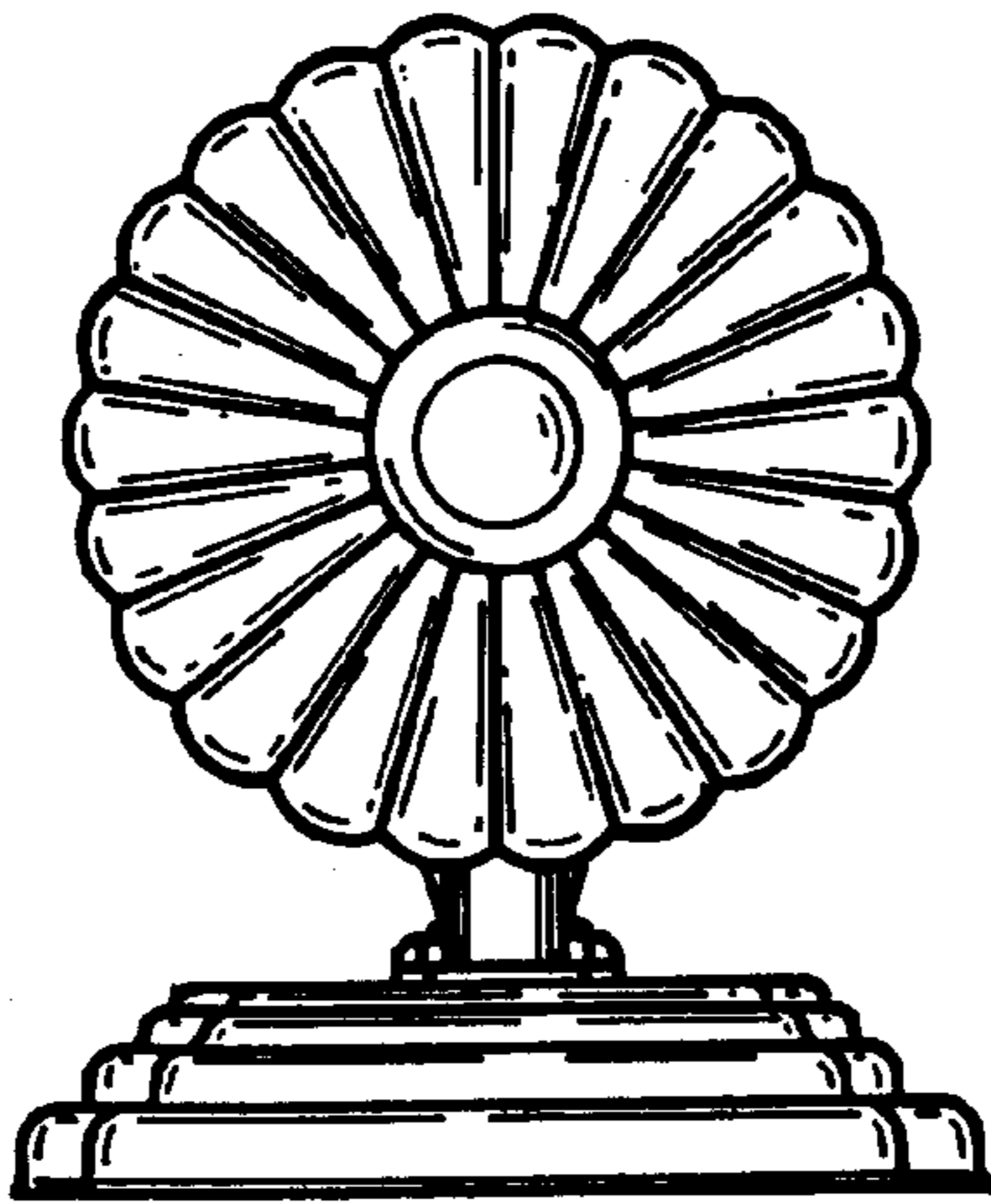

FIG. 7