



US00D410999S

United States Patent [19] Henninge

[11] **Patent Number: Des. 410,999**

[45] **Date of Patent: ** Jun. 15, 1999**

[54] **CAST IRON STOVE**

[75] Inventor: **Paul Henninge**, Burlington, Vt.

[73] Assignee: **NHC, Inc.**, Morrisville, Vt.

[**] Term: **14 Years**

[21] Appl. No.: **29/092,129**

[22] Filed: **Aug. 12, 1998**

[51] **LOC (6) Cl.** **23-03**

[52] **U.S. Cl.** **D23/342; D23/343**

[58] **Field of Search** **D23/342-345,**
D23/350; 126/500, 4, 67, 190

[56] **References Cited**

U.S. PATENT DOCUMENTS

D. 392,376 3/1998 Greene D23/343

Primary Examiner—Lisa Lichtenstein
Attorney, Agent, or Firm—Downs Rachlin & Martin PLLC

[57] **CLAIM**

The ornamental design for a cast iron stove, as shown and described.

DESCRIPTION

FIG. 1 is a front elevation view of the cast iron stove design of the present invention;

FIG. 2 is a side elevation view of the design shown in FIG. 1, the opposite side being a mirror image of that shown;

FIG. 3 is an enlarged partial view of the region of the design shown in FIG. 2 identified by dotted line 3;

FIG. 4 is a top view of the design shown in FIG. 1; and, FIG. 5 is a rear elevation view of the design shown in FIG. 1.

The bottom of the design is not being claimed.

1 Claim, 4 Drawing Sheets

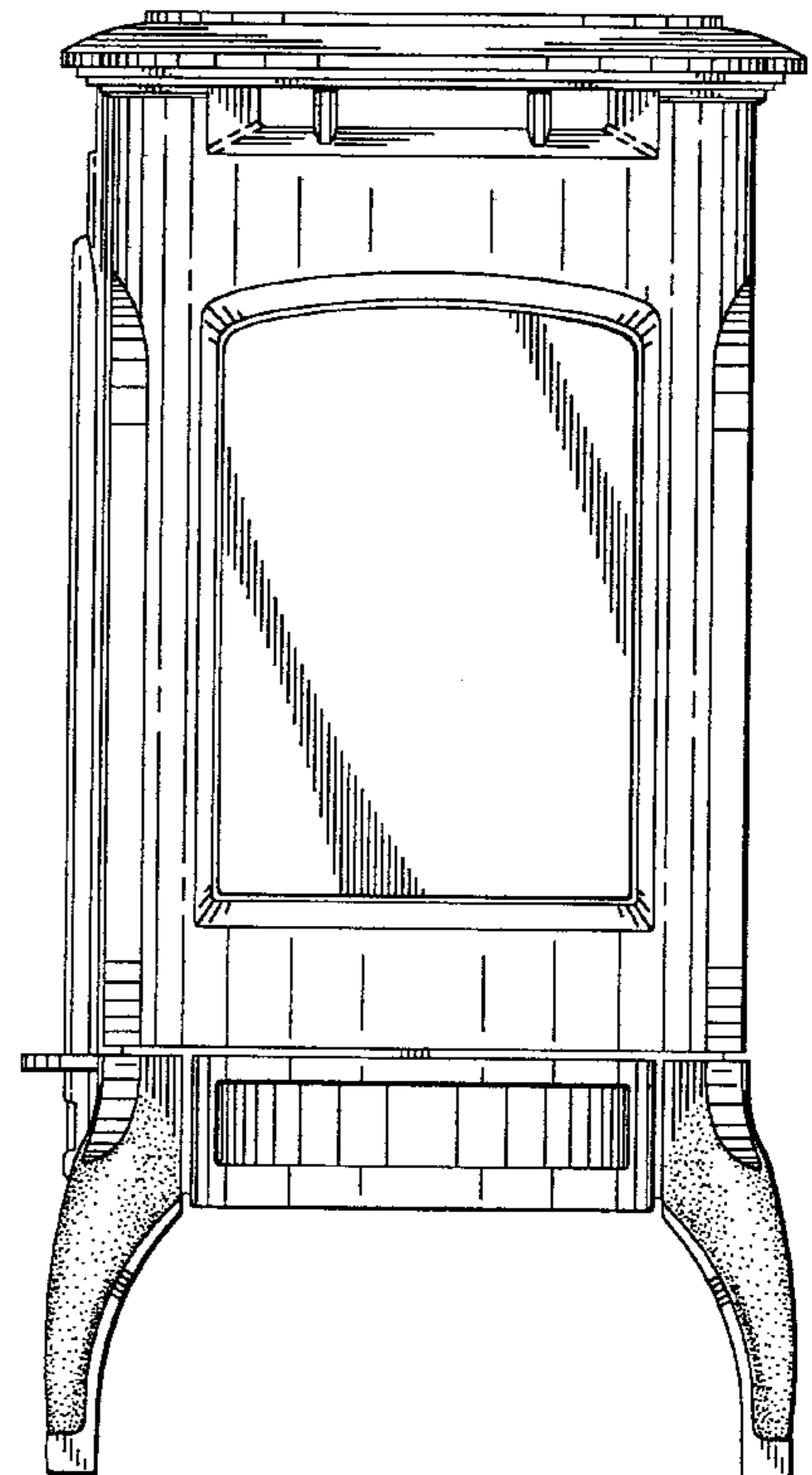
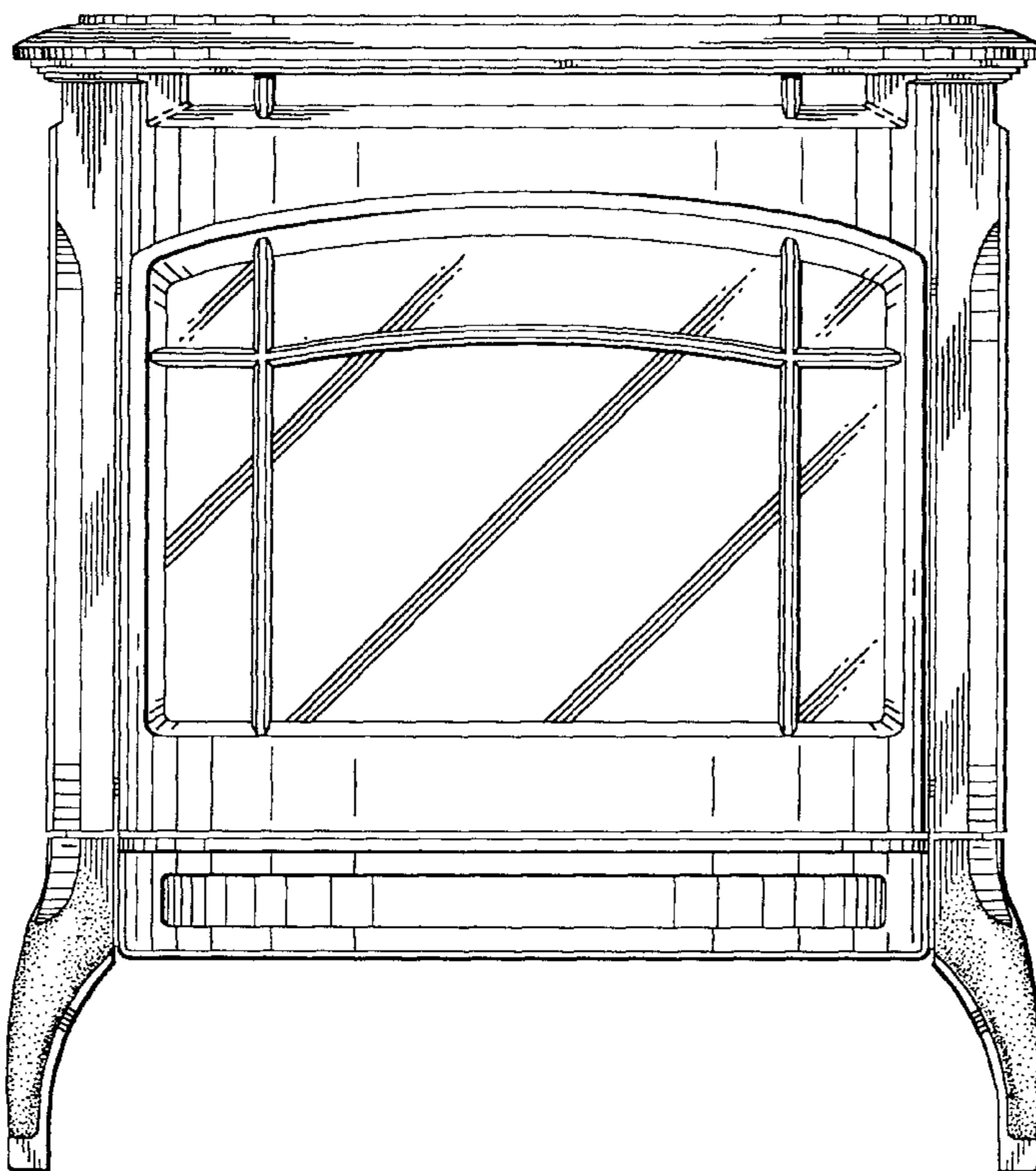

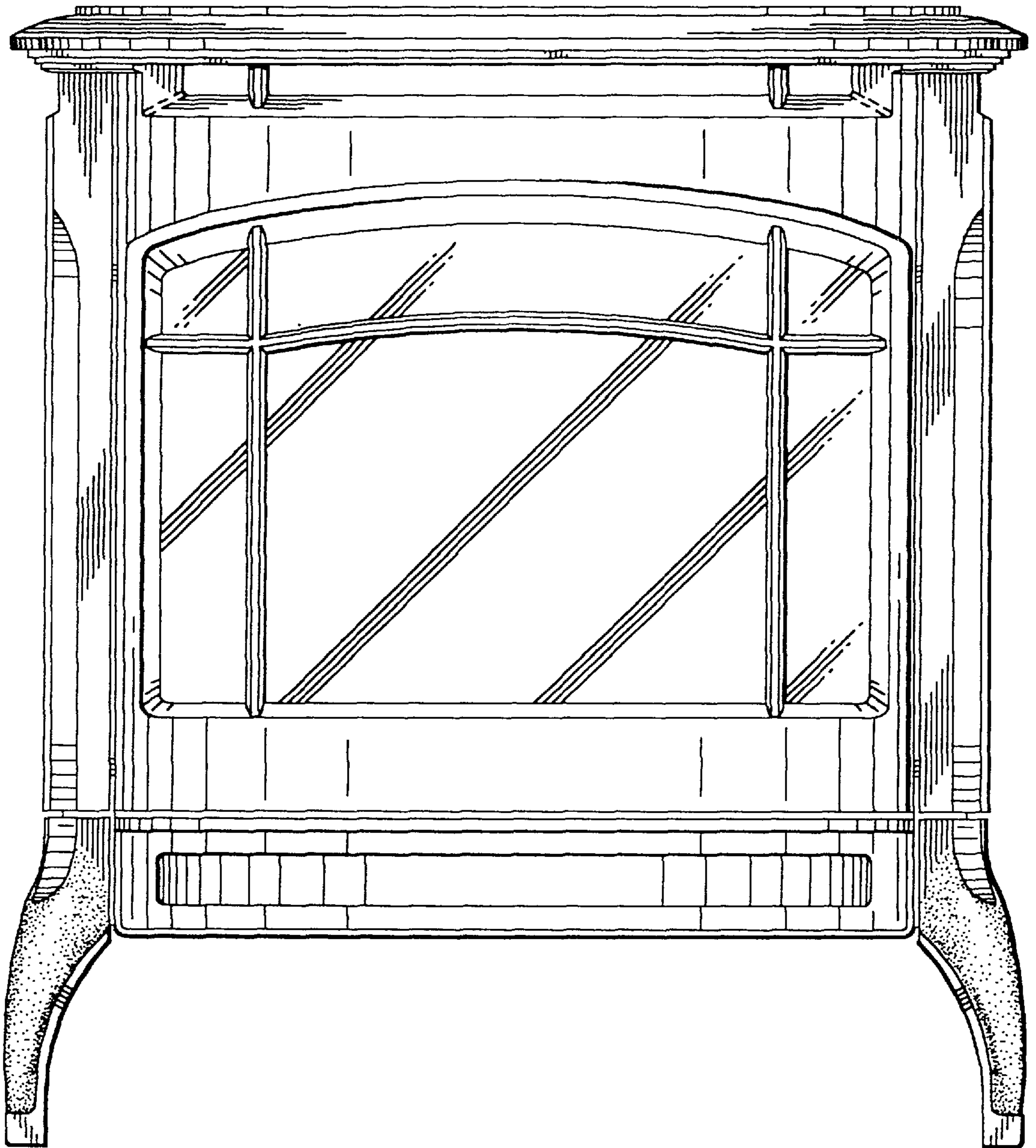

FIG. 1

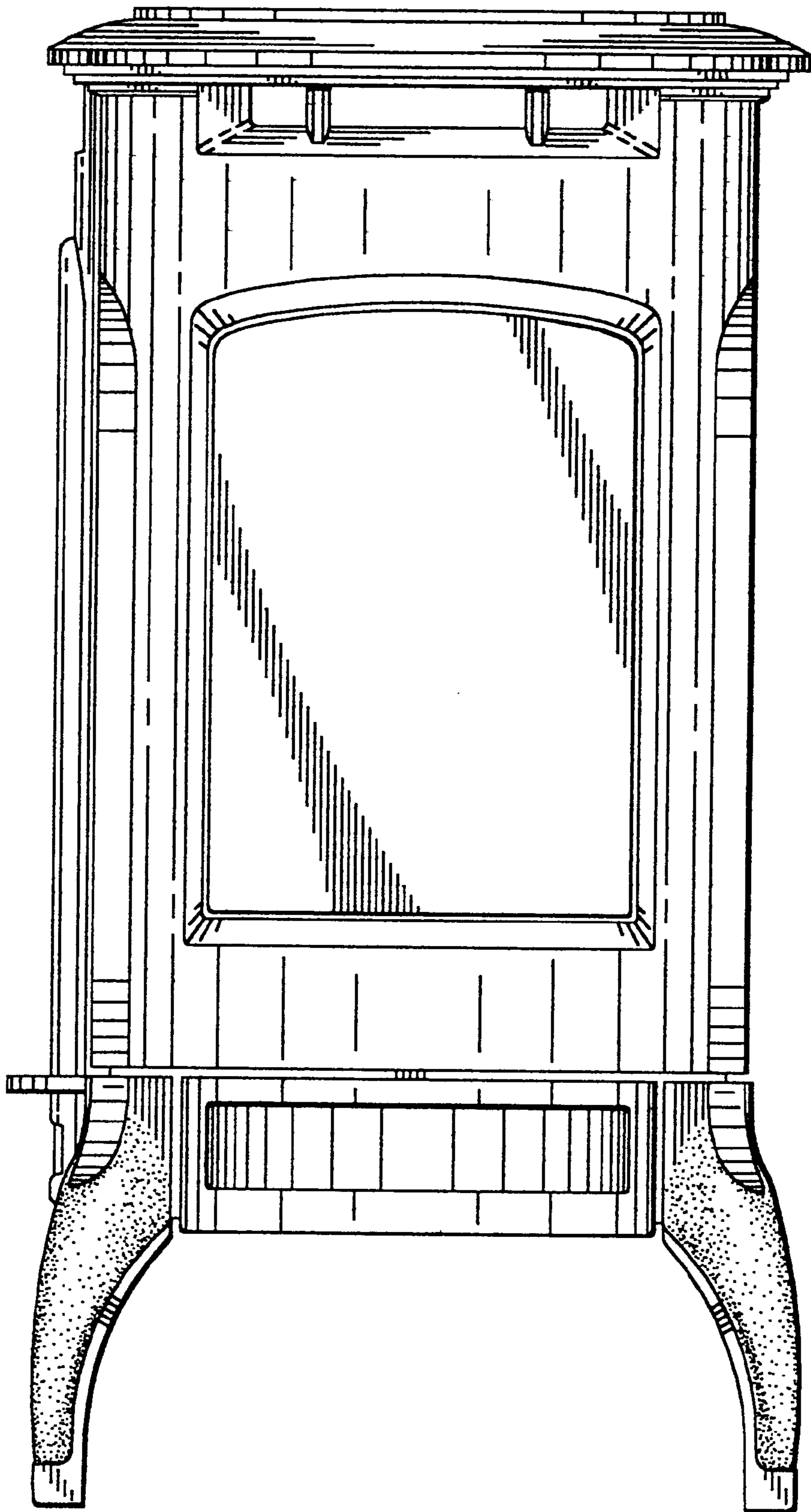

FIG. 2

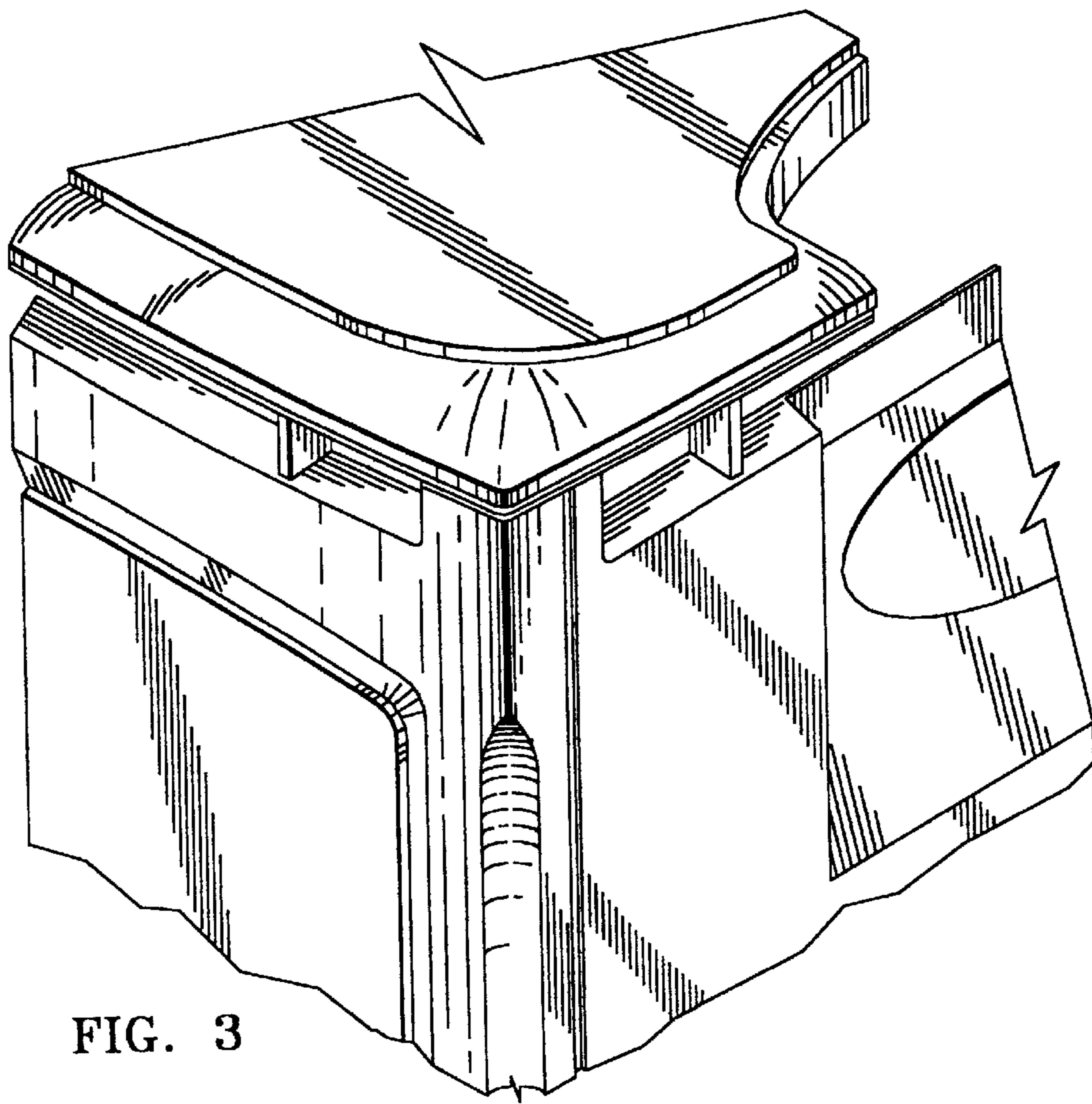

FIG. 3

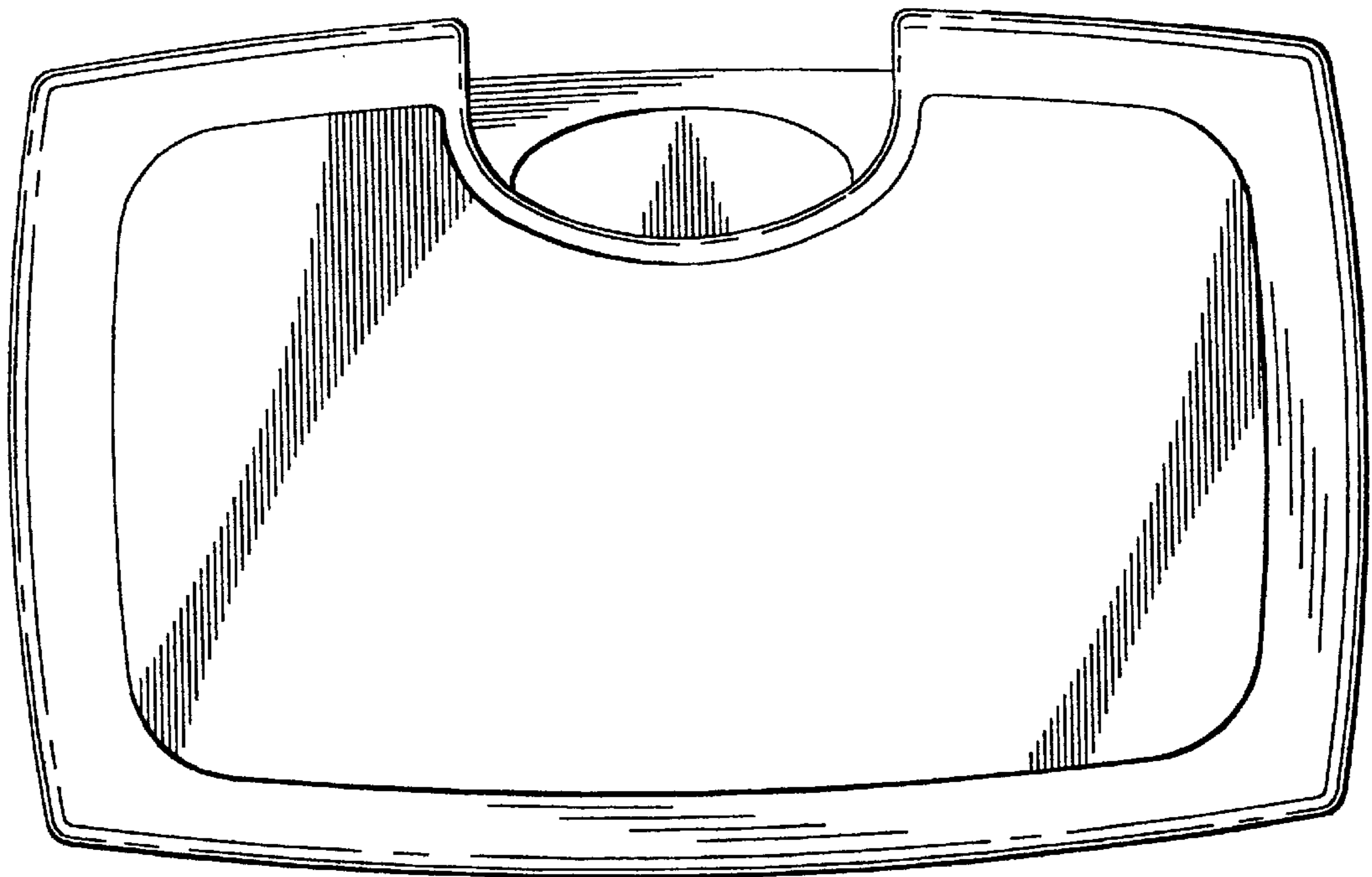

FIG. 4

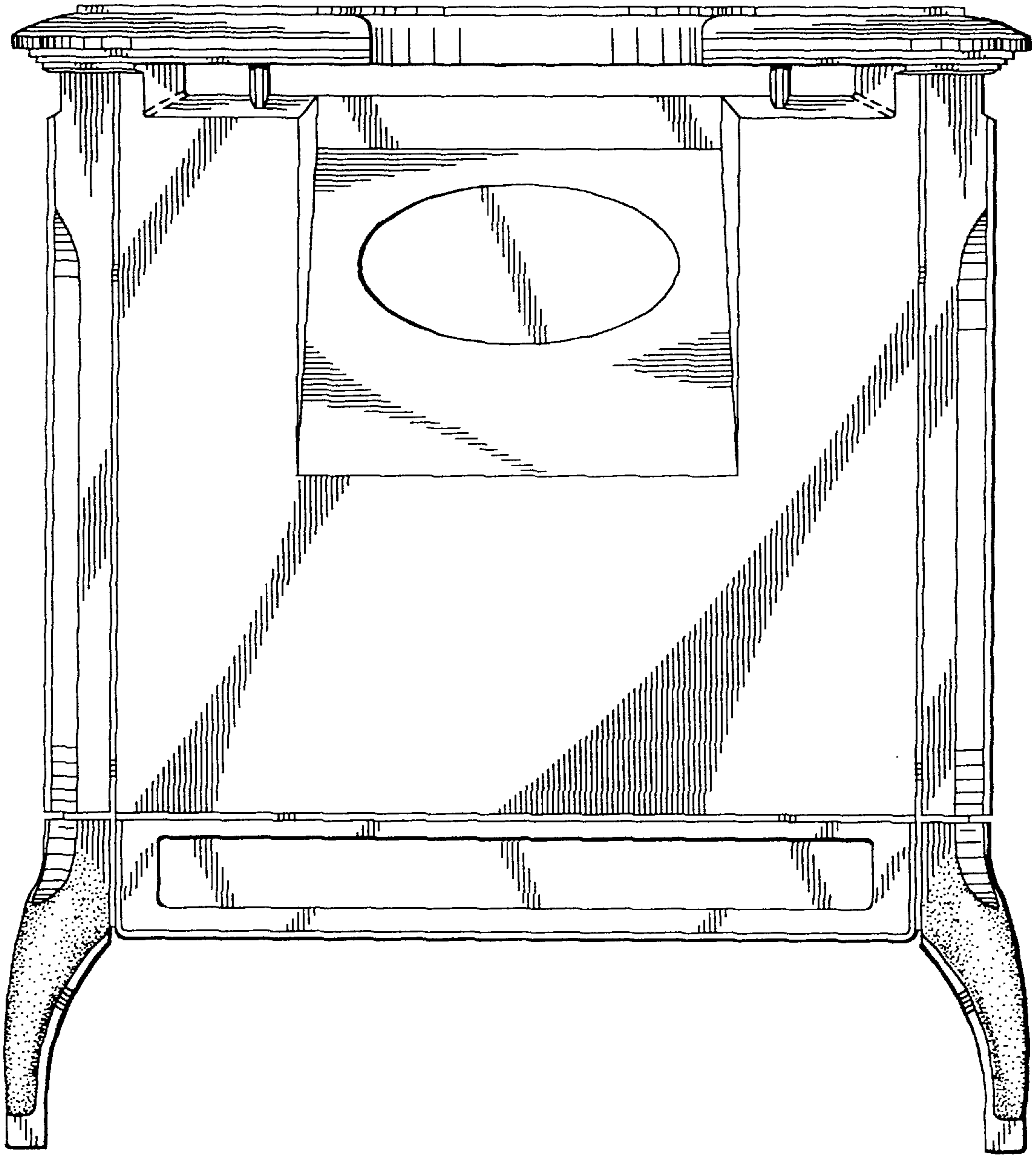

FIG. 5