



US00D410963S

**United States Patent** [19]  
**Parisotto**

[11] **Patent Number: Des. 410,963**

[45] **Date of Patent: \*\* Jun. 15, 1999**

[54] **SPORTS BOOT**

[75] **Inventor: Davide Parisotto, Casella d'Asolo, Italy**

[73] **Assignee: Calzaturificio S.C.A.R.P.A. S.p.A., Via Tiziano, Italy**

[\*\*] **Term: 14 Years**

[21] **Appl. No.: 29/077,673**

[22] **Filed: Oct. 7, 1997**

[51] **LOC (6) Cl. .... 02-04**

[52] **U.S. Cl. .... D2/904**

[58] **Field of Search .... D2/904, 902; 36/15, 36/83, 89, 119.1, 84, 122, 117.1-117.9**

[56] **References Cited**

**U.S. PATENT DOCUMENTS**

D. 258,771	4/1981	Vaccari .....	D2/904
D. 342,593	12/1993	Balbinot .....	D2/904
D. 357,570	4/1995	Parisotto .....	D2/904
D. 362,107	9/1995	Ostinet et al. ....	D2/904
D. 366,136	1/1996	Locker et al. ....	D2/904

D. 374,760	10/1996	Edauw .....	D2/902
D. 381,193	7/1997	Pamino .....	D2/902
D. 382,098	8/1997	Pamino .....	D2/902
4,245,410	1/1981	Molitor .....	36/117
4,542,599	9/1985	Annovi .....	36/15
4,574,499	3/1986	Olivieri .....	36/117.1
5,031,340	7/1991	Hilgarth .....	36/117.1

*Primary Examiner*—Louis S. Zarfaz  
*Assistant Examiner*—G. Andoll  
*Attorney, Agent, or Firm*—Stroock & Stroock & Lavan LLP

[57] **CLAIM**

The ornamental design for a sports boot, as shown and described.

**DESCRIPTION**

FIG. 1 is a right-hand side view of a sports boot showing my new design;  
FIG. 2 is a rear view thereof;  
FIG. 3 is a left-hand side view thereof;  
FIG. 4 is a front view thereof;  
FIG. 5 is a plan view thereof; and,  
FIG. 6 is an underside view thereof.

**1 Claim, 3 Drawing Sheets**

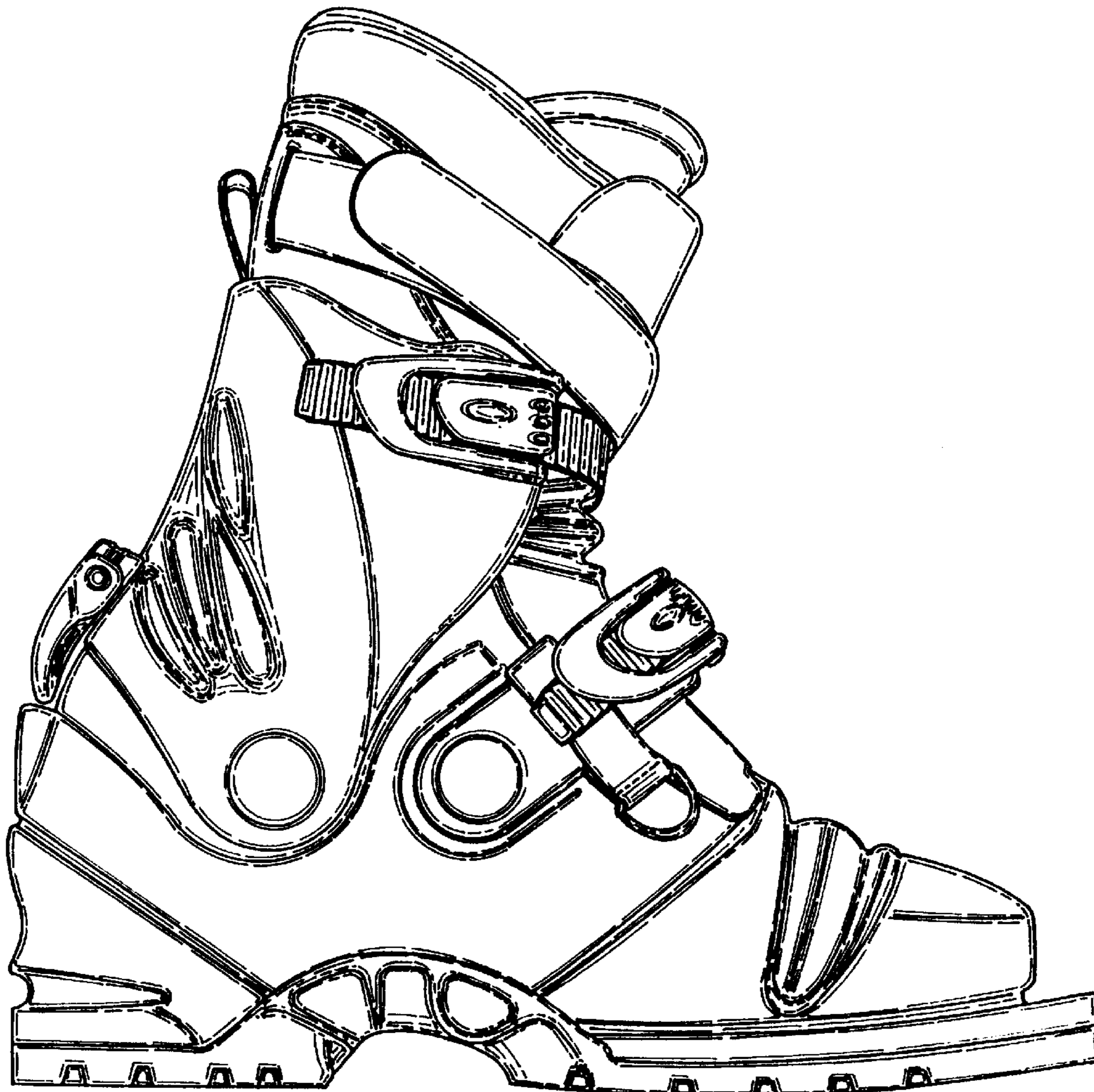

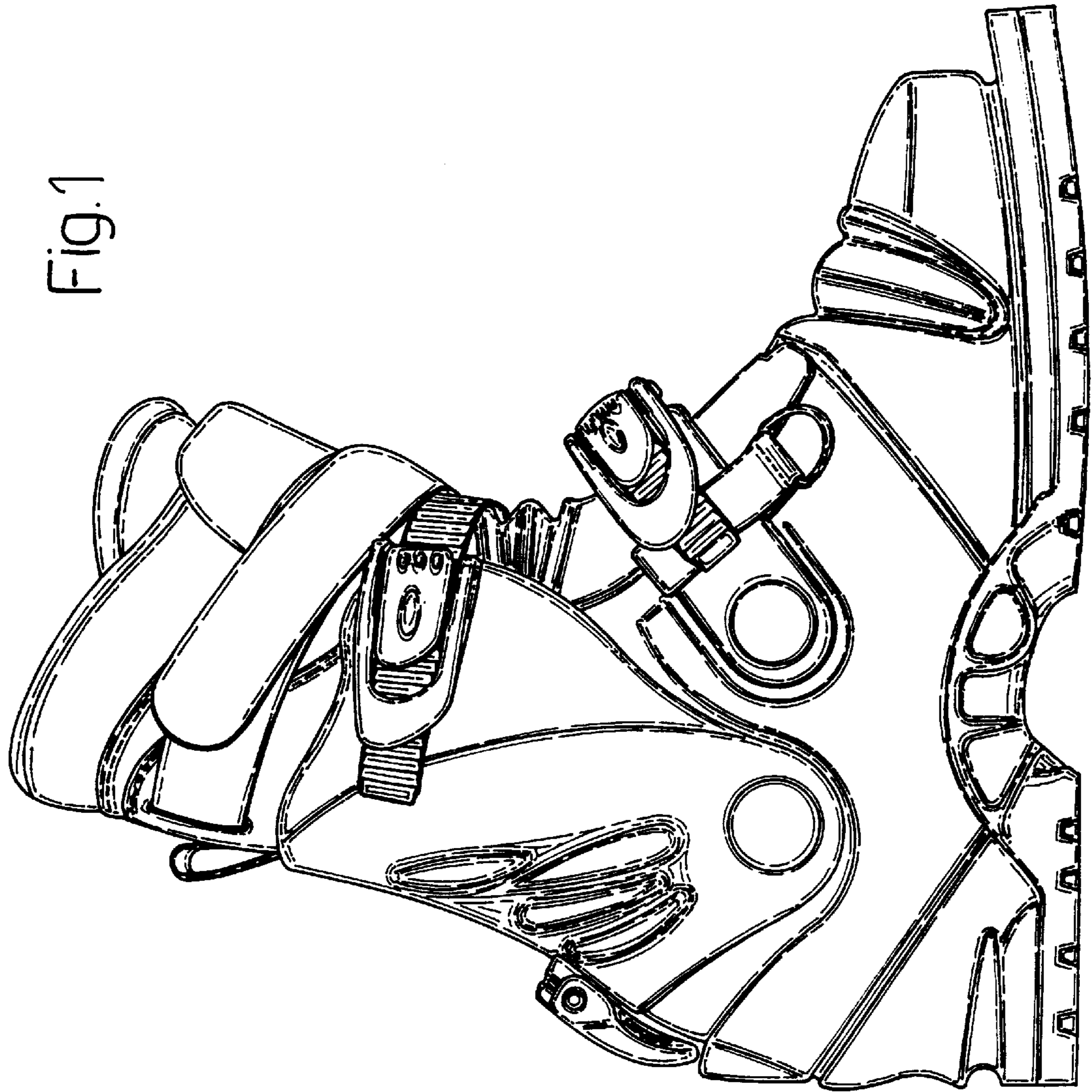

Fig. 1

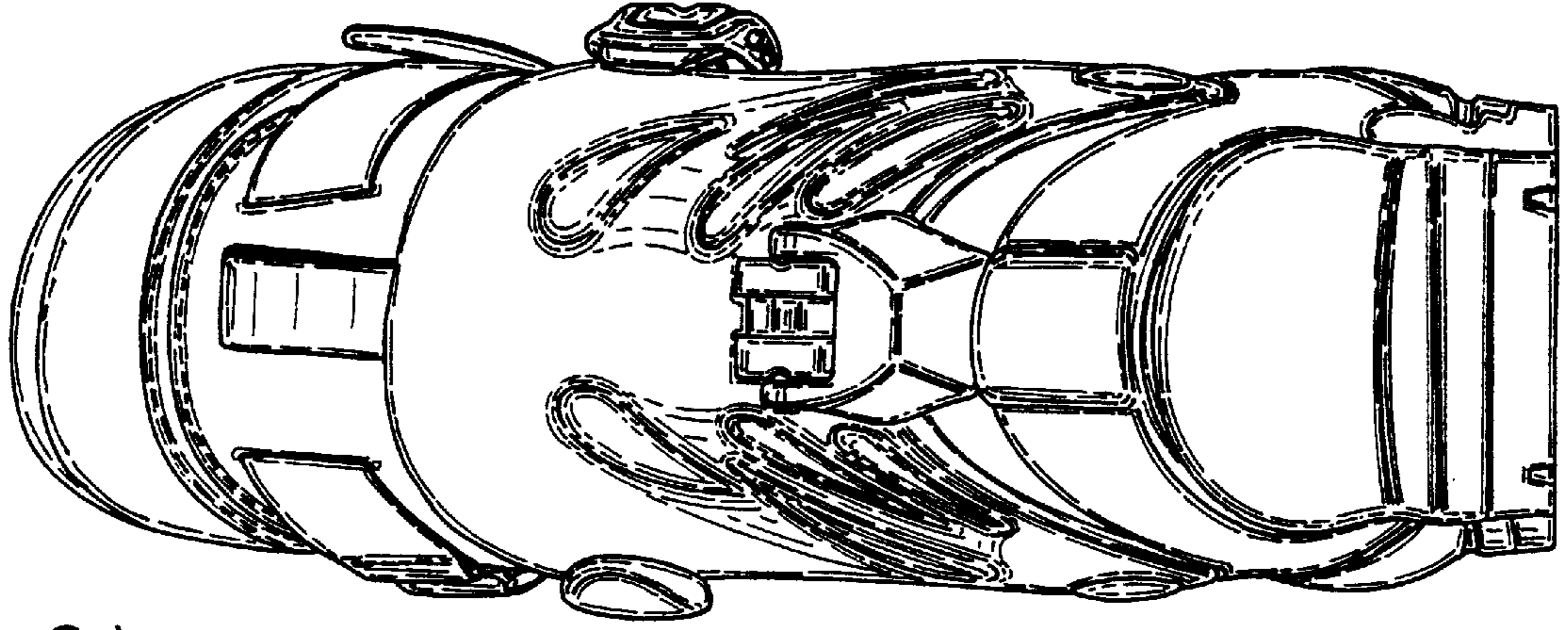

Fig. 2



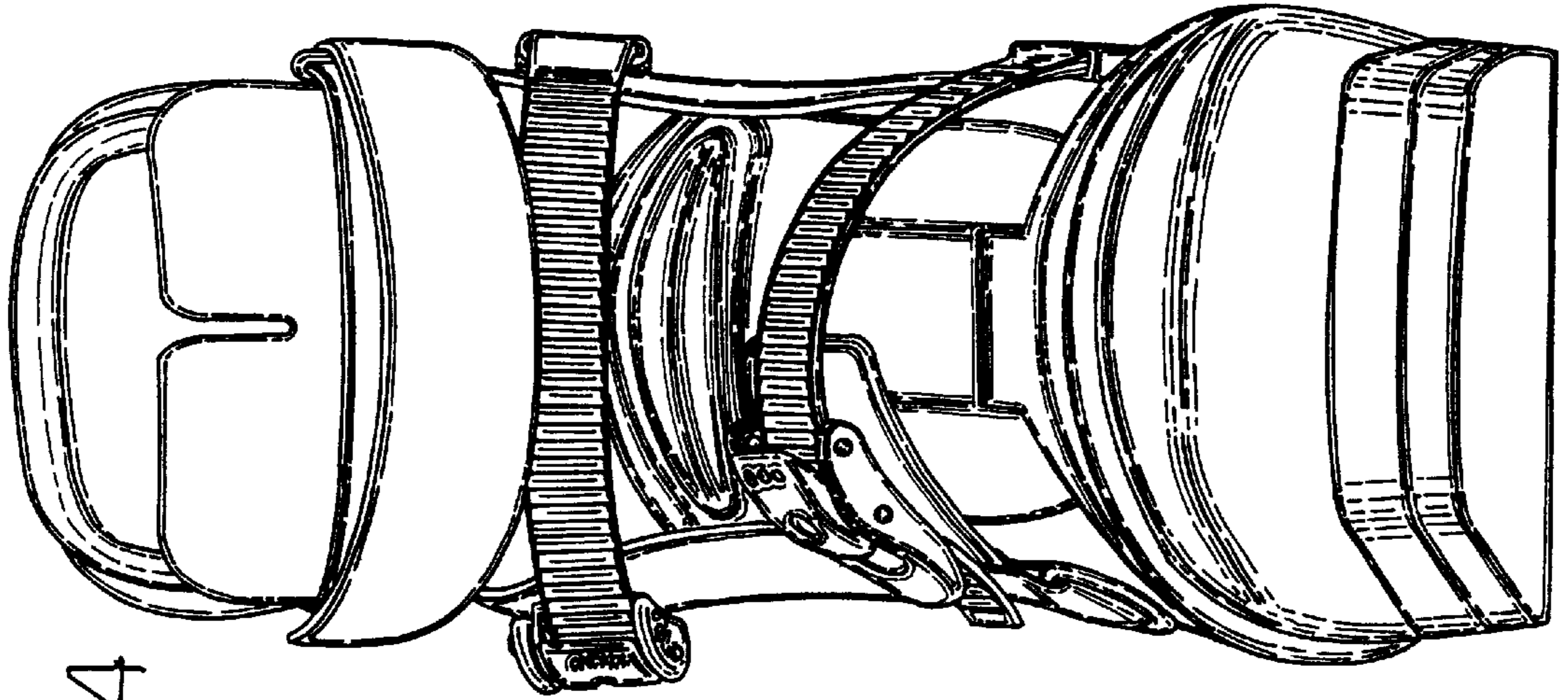

Fig. 4

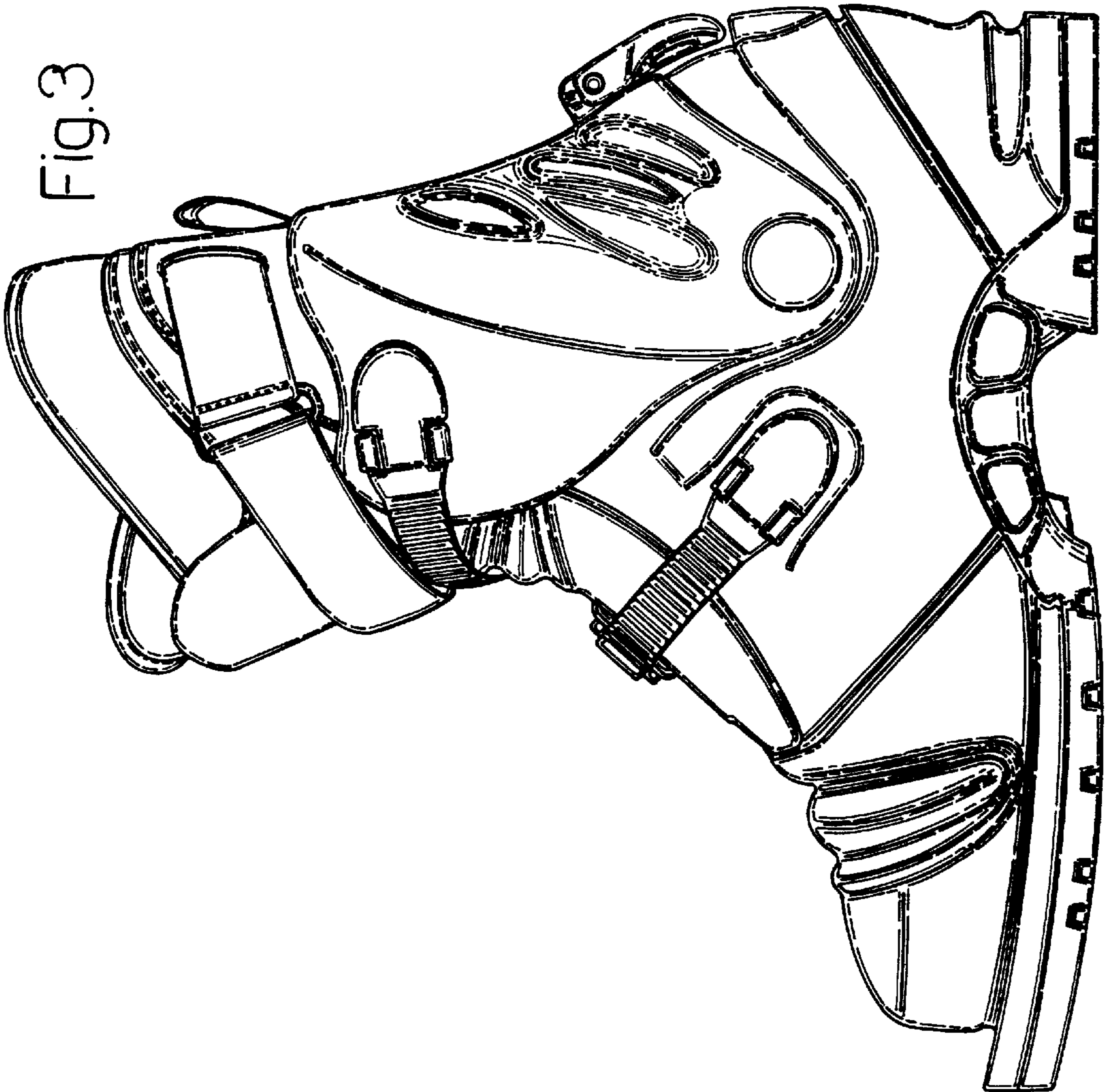

Fig. 3

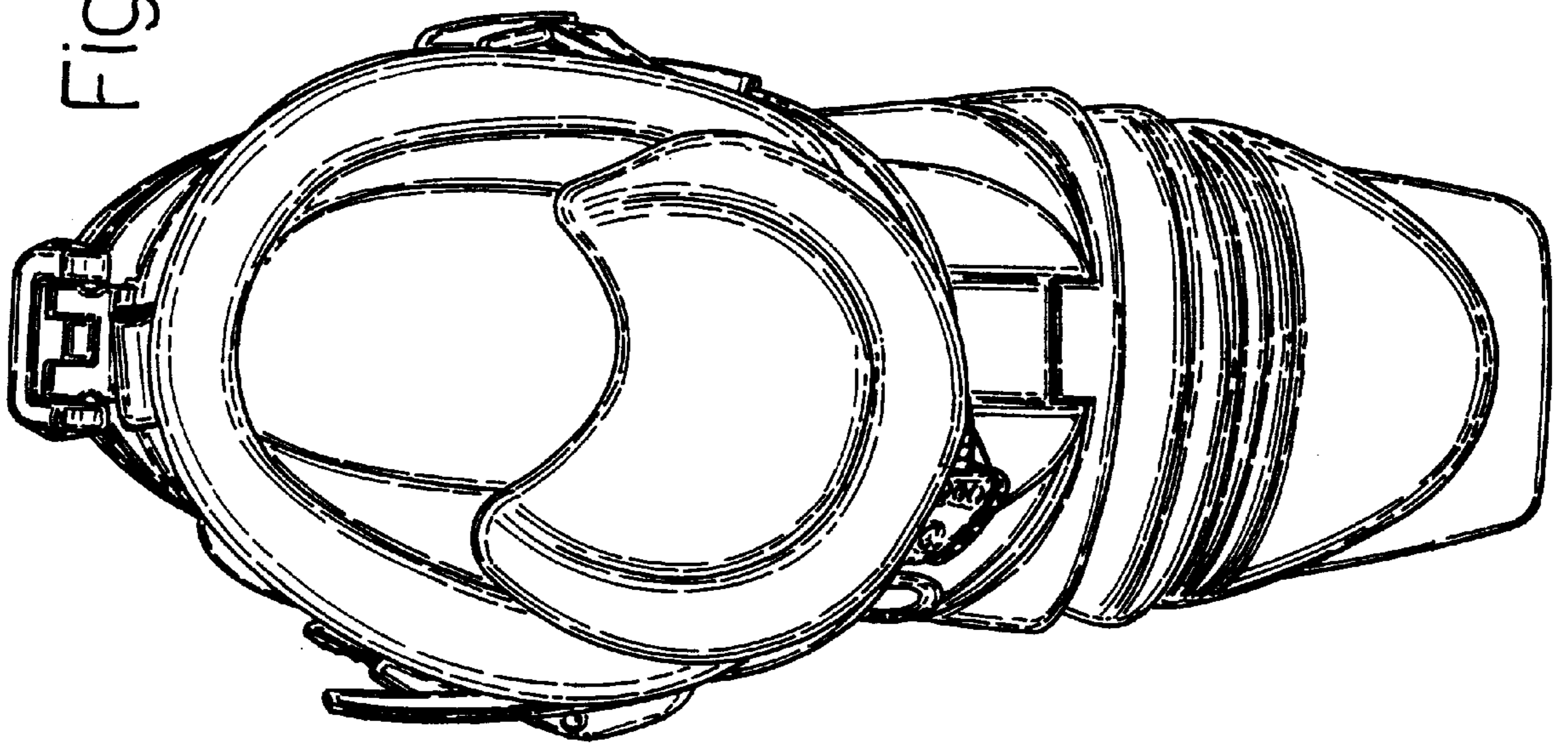

Fig. 5

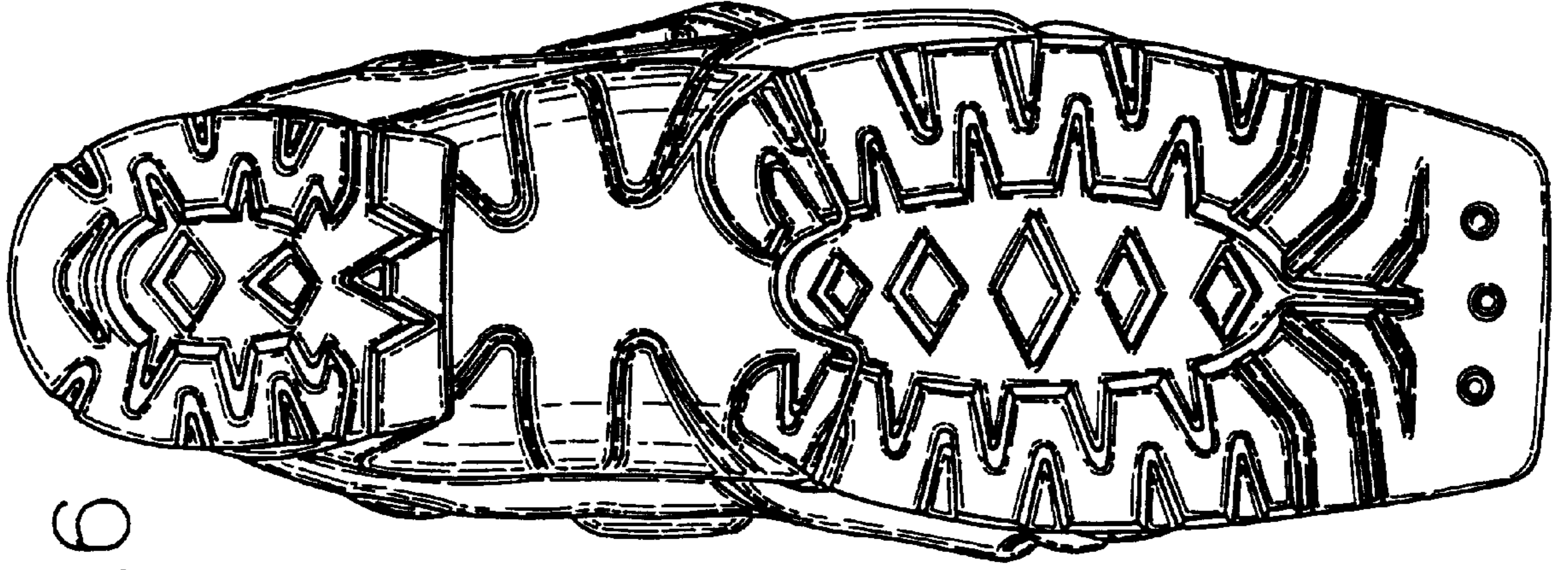

Fig. 6