



US00D410953S

**United States Patent** [19]  
**vom Braucke et al.**

[11] **Patent Number: Des. 410,953**  
[45] **Date of Patent: \*\* Jun. 15, 1999**

[54] **MEMO BOARD**

[75] Inventors: **Manfred vom Braucke**, Bielefeld;  
**Hans vom Braucke**, Vlotho, both of  
Germany

[73] Assignee: **Bielefelder Küchemaschinen-und  
Transportgeräte-Fabrik vom Braucke  
GmbH**, Bielefeld, Germany

[\*\*] Term: **14 Years**

[21] Appl. No.: **29/081,730**

[22] Filed: **Jan. 8, 1998**

[30] **Foreign Application Priority Data**

Jul. 18, 1997 [DE] Germany ..... 97 06 593

[51] **LOC (6) Cl.** ..... **19-06**

[52] **U.S. Cl.** ..... **D19/52; D6/553; D20/42;  
D19/90; D19/85; D19/69**

[58] **Field of Search** ..... **D6/553, 569, 570;  
D20/19, 18, 42; D19/52, 20, 65, 22, 75,  
67-69, 90, 91, 99, 100; 206/214; 40/1,  
124, 124.2, 124.4, 905; 211/69.1-69.9,  
13.1, 88.01, 10, 11, DIG. 1**

[56] **References Cited**

**U.S. PATENT DOCUMENTS**

D. 049,937 11/1916 Sebree ..... D19/90 X

D. 196,306 9/1963 Bodenbach ..... D19/52 X  
D. 199,243 9/1964 Chick ..... D20/18  
D. 267,608 1/1983 Brescia et al. .... D6/570  
D. 302,986 8/1989 Takai et al. .... D19/52  
D. 337,906 8/1993 Digiudio ..... D19/52  
D. 369,621 5/1996 Kraye, Jr. et al. .... D19/69 X  
D. 370,936 6/1996 Hofman et al. .... D19/52  
D. 394,456 5/1998 Jack ..... D19/52  
5,385,230 1/1995 Nygard et al. .... 206/214  
5,755,338 5/1998 Vom Braucke et al. .... 211/13.1

*Primary Examiner*—Martie K. Holtje  
*Attorney, Agent, or Firm*—Burns, Doane, Swecker &  
Mathis, L.L.P.

[57] **CLAIM**

We claim the ornamental design for a memo board, as shown  
and described.

**DESCRIPTION**

FIG. 1 is a front view of a memo board showing our new  
design;  
FIG. 2 is a top view of FIG. 1;  
FIG. 3 is a bottom view of FIG. 1;  
FIG. 4 is a left side view of FIG. 1, with the right side view  
being a mirror-image thereof;  
FIG. 5 is a top, front perspective view of FIG. 1;  
FIG. 6 is a bottom, front perspective view of FIG. 1; and,  
FIG. 7 is a rear view of FIG. 1.

**1 Claim, 6 Drawing Sheets**

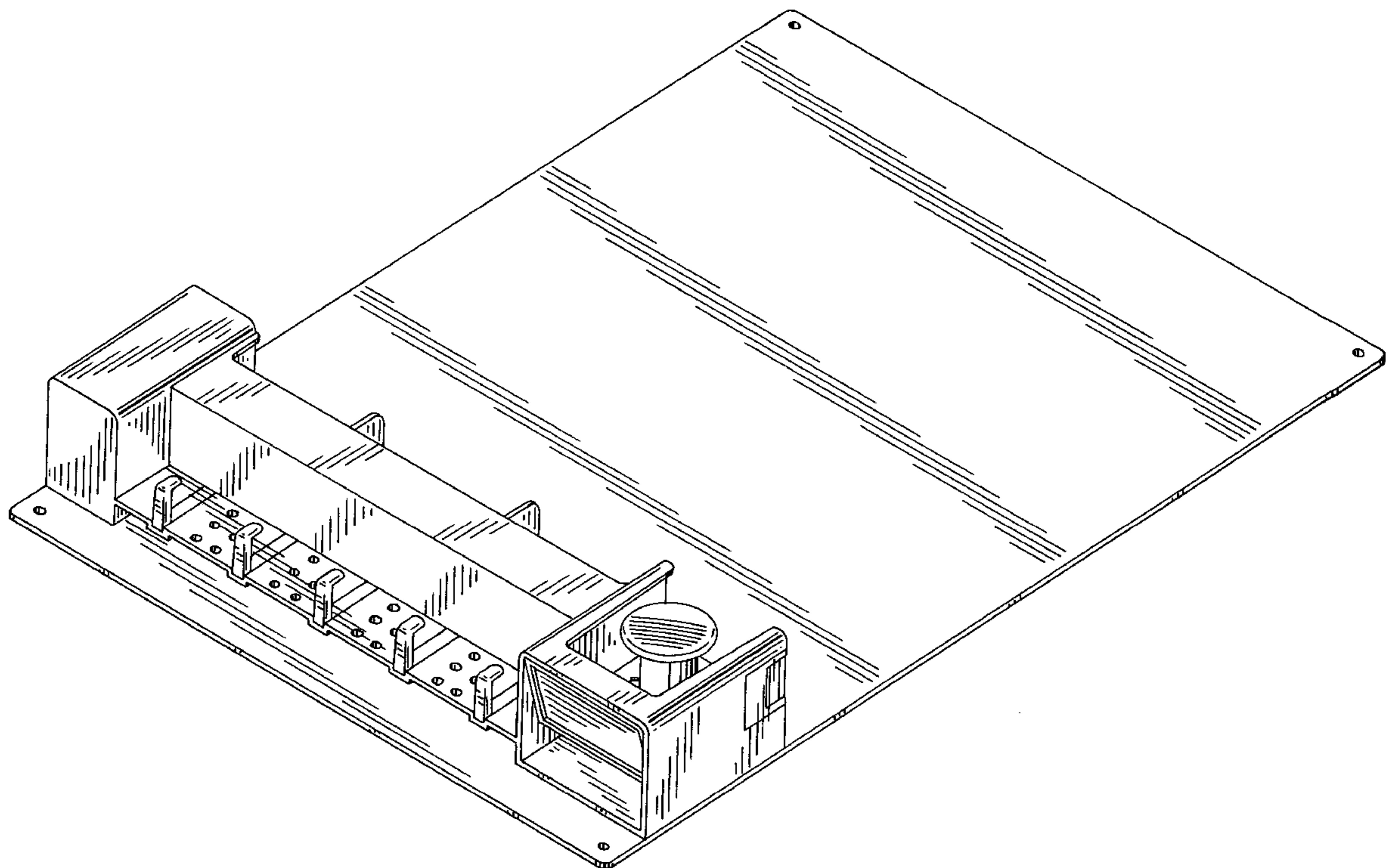
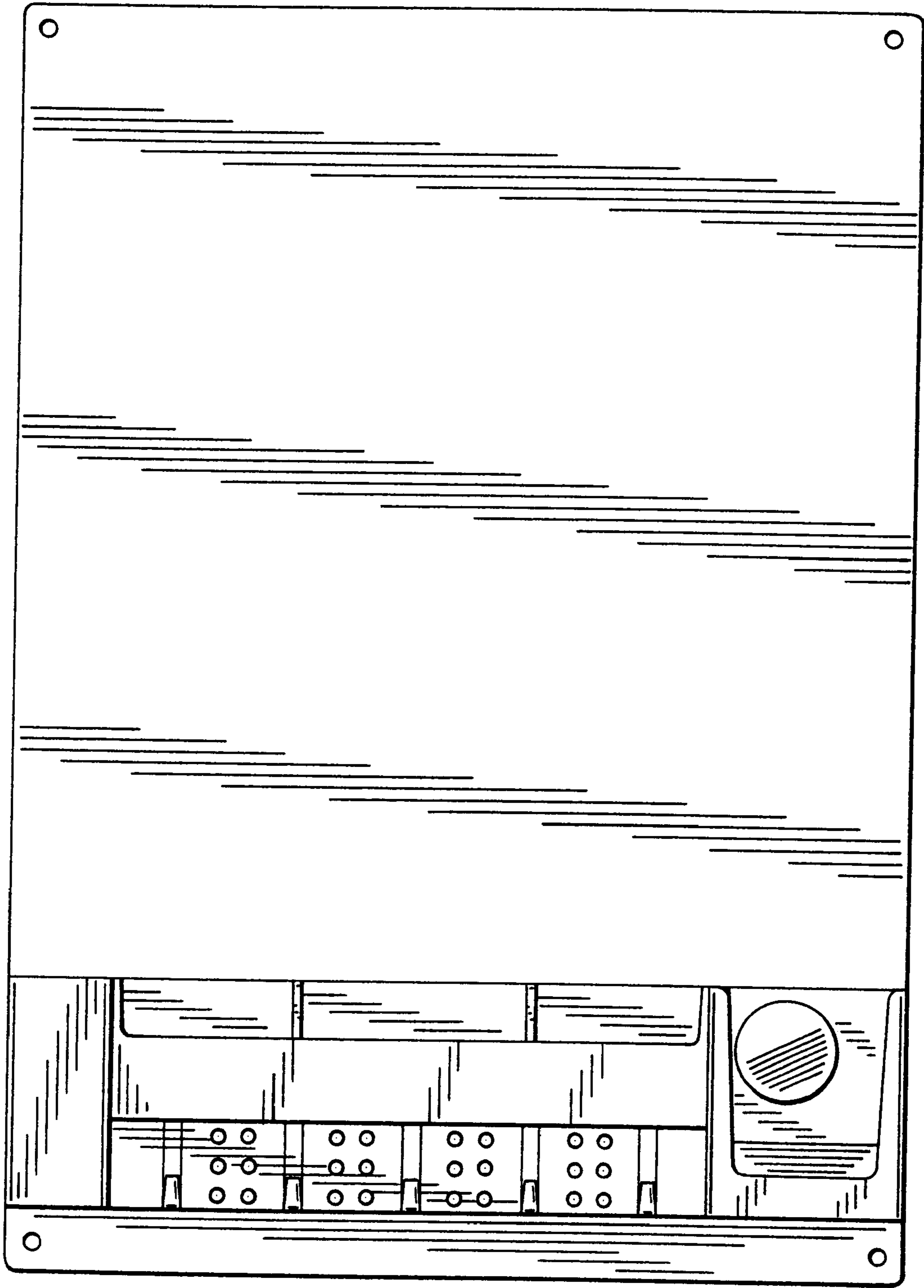

Fig. 1



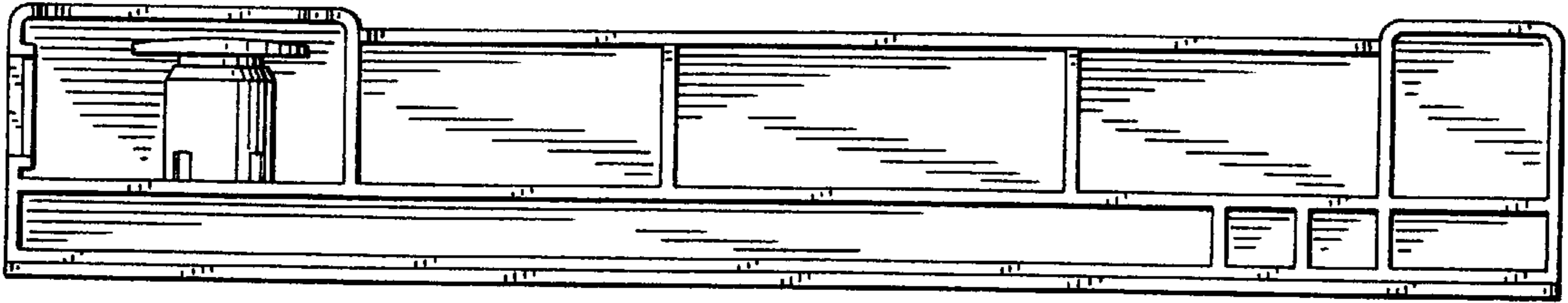

Fig. 2

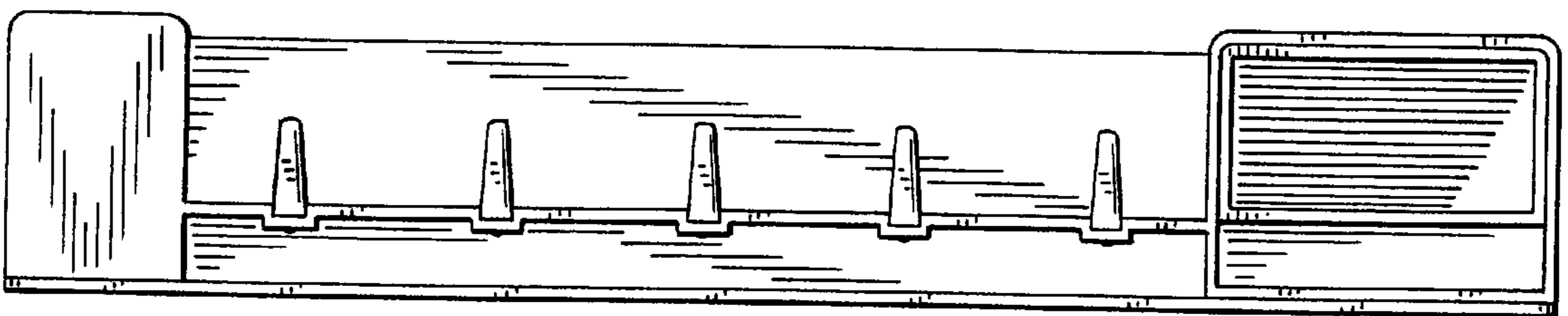
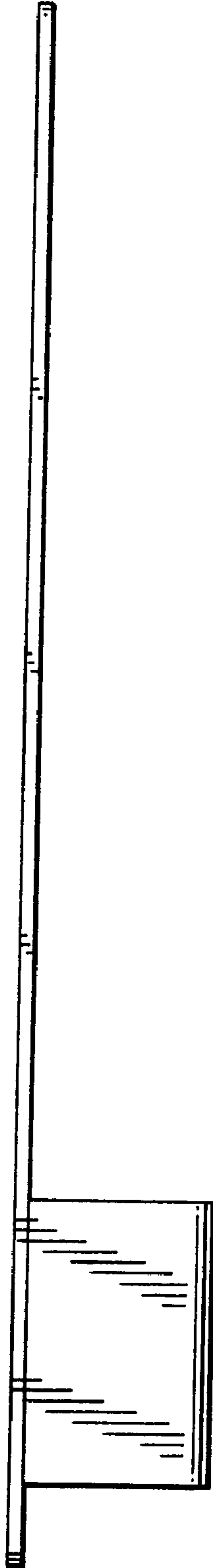

Fig. 3

Fig. 4



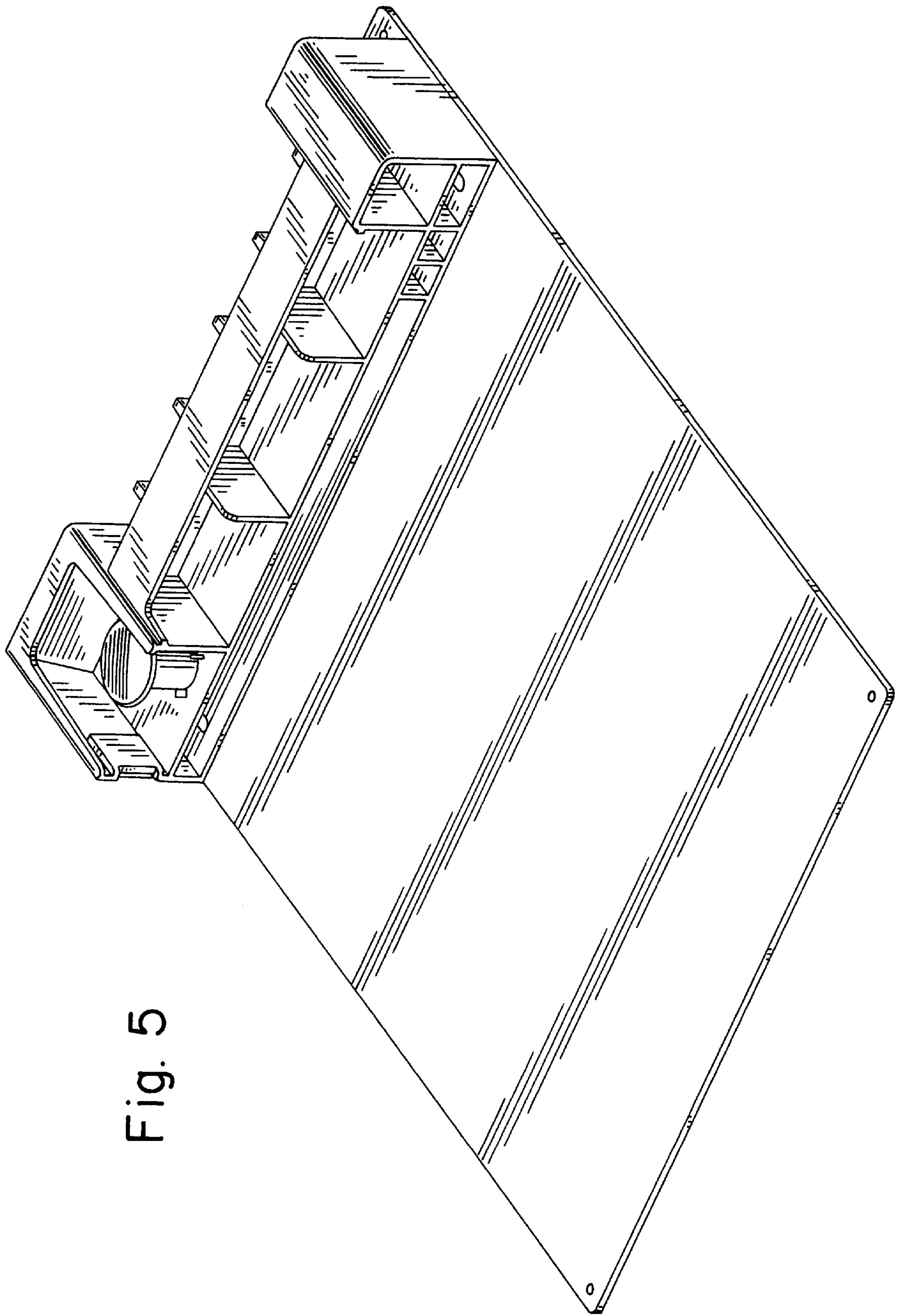

Fig. 5

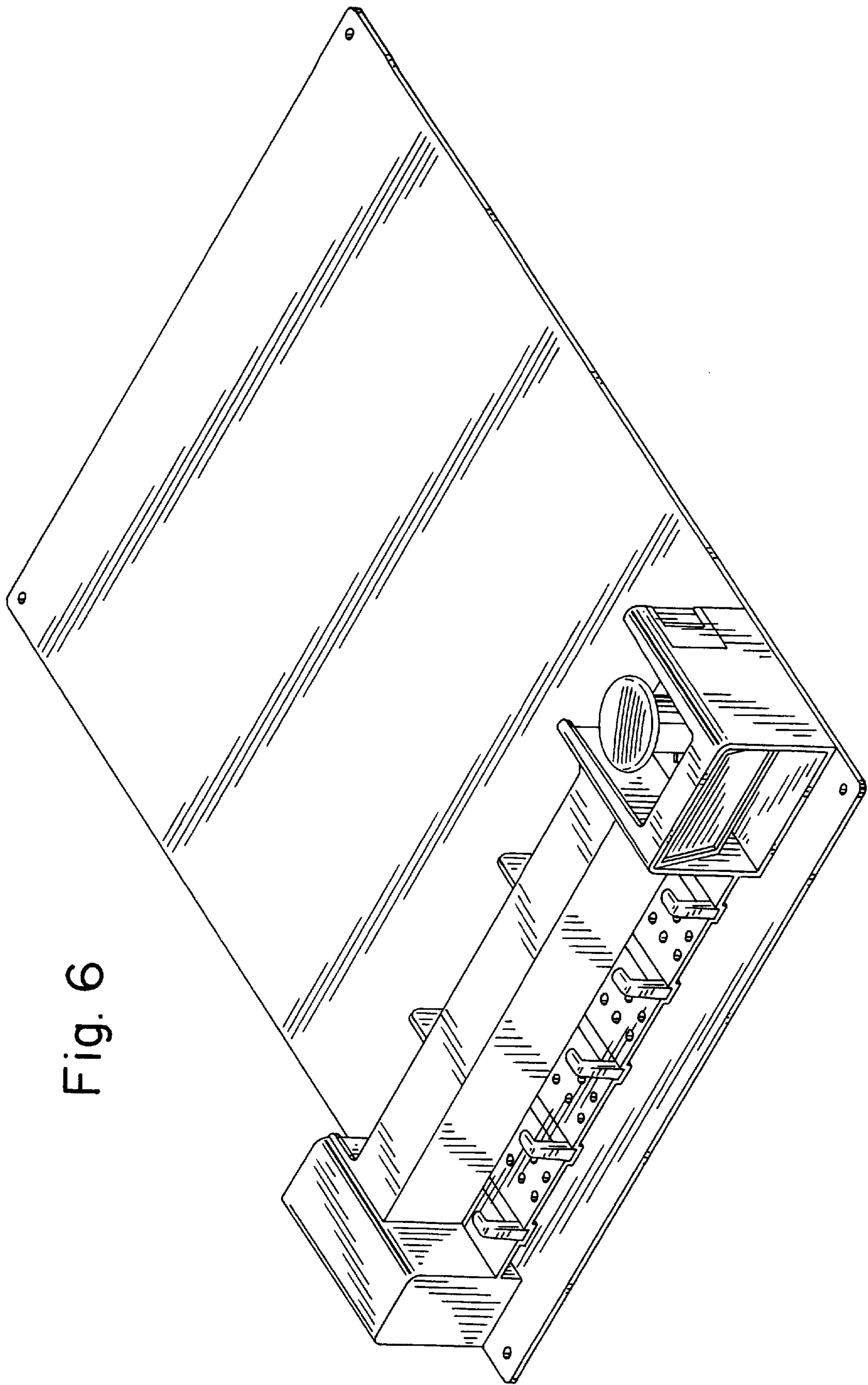

Fig. 6

Fig. 7

