



US00D410925S

United States Patent [19]

Kawase et al.

[11] Patent Number: **Des. 410,925**

[45] Date of Patent: **** Jun. 15, 1999**

[54] **AUDIO DISC PLAYER COMBINED WITH RADIO RECEIVER AND TAPE RECORDER**

[75] Inventors: **Atsushi Kawase; Keitaro Tsuboki**, both of Tokyo, Japan

[73] Assignee: **Sony Corporation**, Tokyo, Japan

[**] Term: **14 Years**

[21] Appl. No.: **29/085,848**

[22] Filed: **Mar. 31, 1998**

[51] **LOC (6) Cl.** **14-01**

[52] **U.S. Cl.** **D14/168**

[58] **Field of Search** D14/124, 156, D14/160-168, 188-190, 192-198; 455/344-347, 351

[56] **References Cited**

U.S. PATENT DOCUMENTS

D. 307,010	4/1990	Fuke	D14/163
D. 309,454	7/1990	Mori	D14/163
D. 351,595	10/1994	Furui	D14/168
5,146,618	9/1992	Wenner	D14/168 X

OTHER PUBLICATIONS

Sony Catalog "MD Walkman" pp. 106-107 (Nov. 1997).

Primary Examiner—Ted Shooman

Assistant Examiner—Nanda Bondade

Attorney, Agent, or Firm—Foley & Lardner

[57] **CLAIM**

The ornamental design for an audio disc player combined with a radio receiver and a tape recorder, as shown and described.

DESCRIPTION

FIG. 1 is a perspective view of an audio disc player combined with a radio receiver and a tape recorder showing our new design;

FIG. 2 is a top plan view thereof;

FIG. 3 is a left side elevational view thereof;

FIG. 4 is a front elevational view thereof;

FIG. 5 is a right side elevational thereof;

FIG. 6 is a rear elevational view thereof; and

FIG. 7 is a perspective view thereof, wherein the lid portion of the first embodiment is in the open position. The portion in broken line is for illustrative purpose only and forms no part of claimed design.

1 Claim, 4 Drawing Sheets

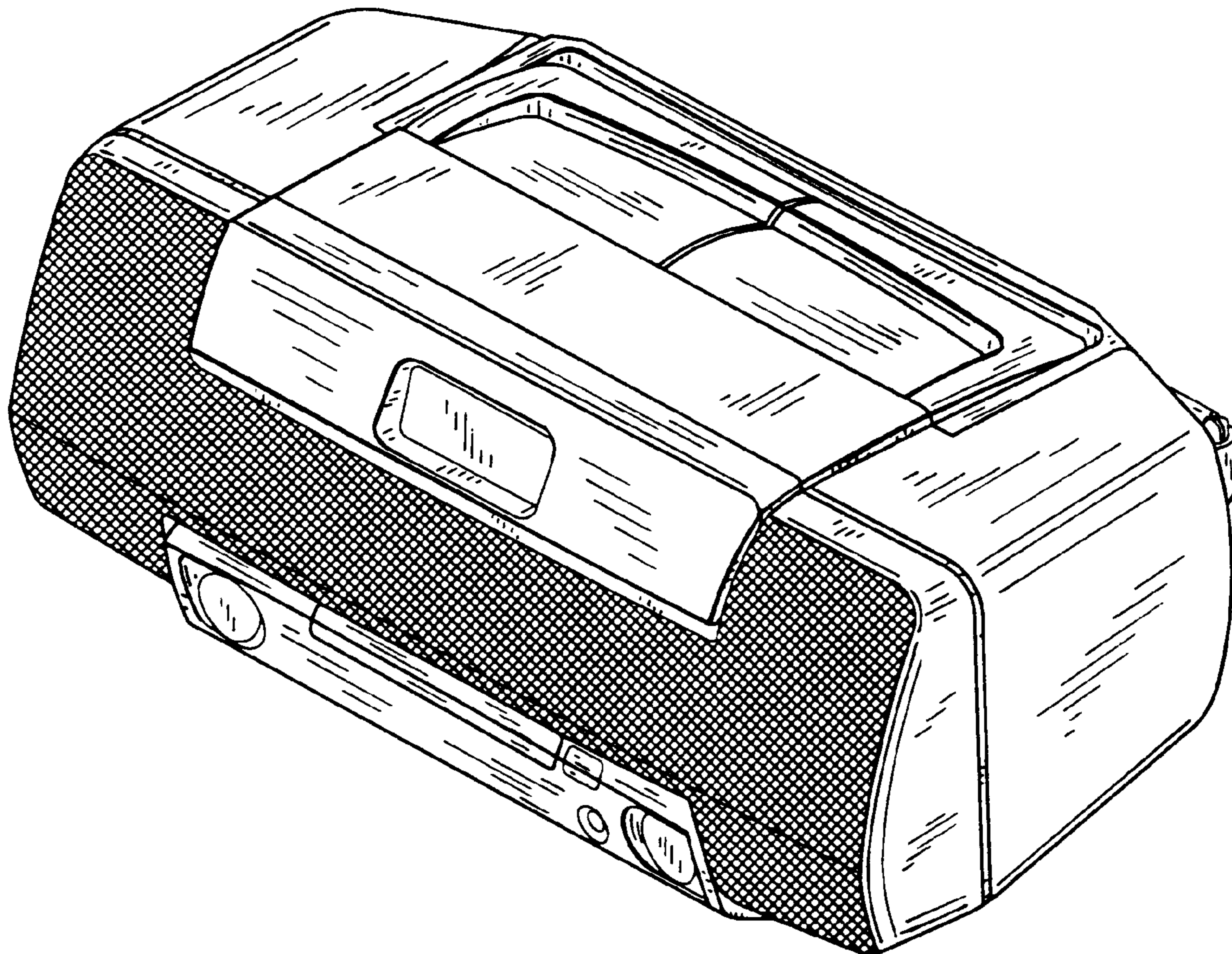

FIG. 1

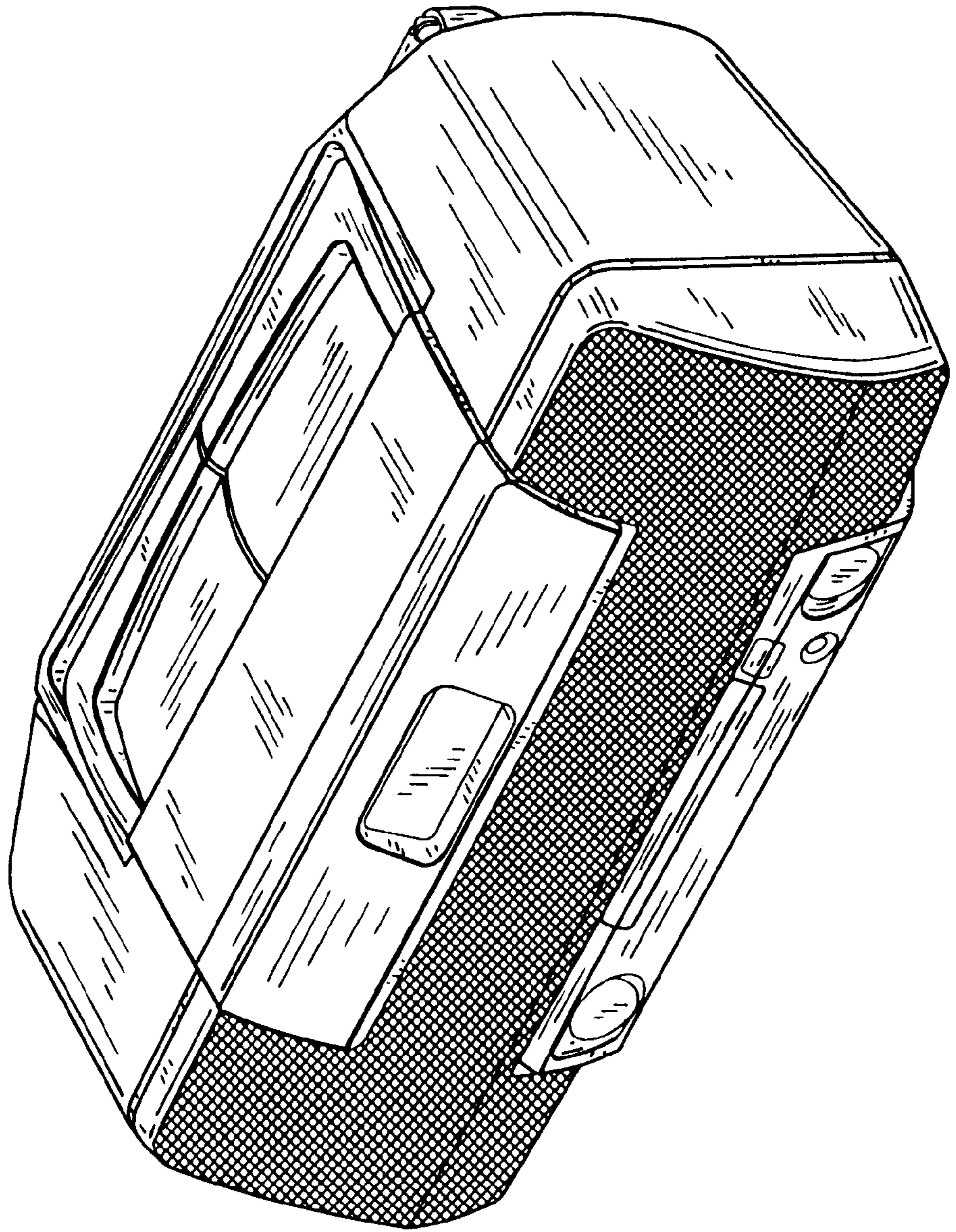

FIG. 2

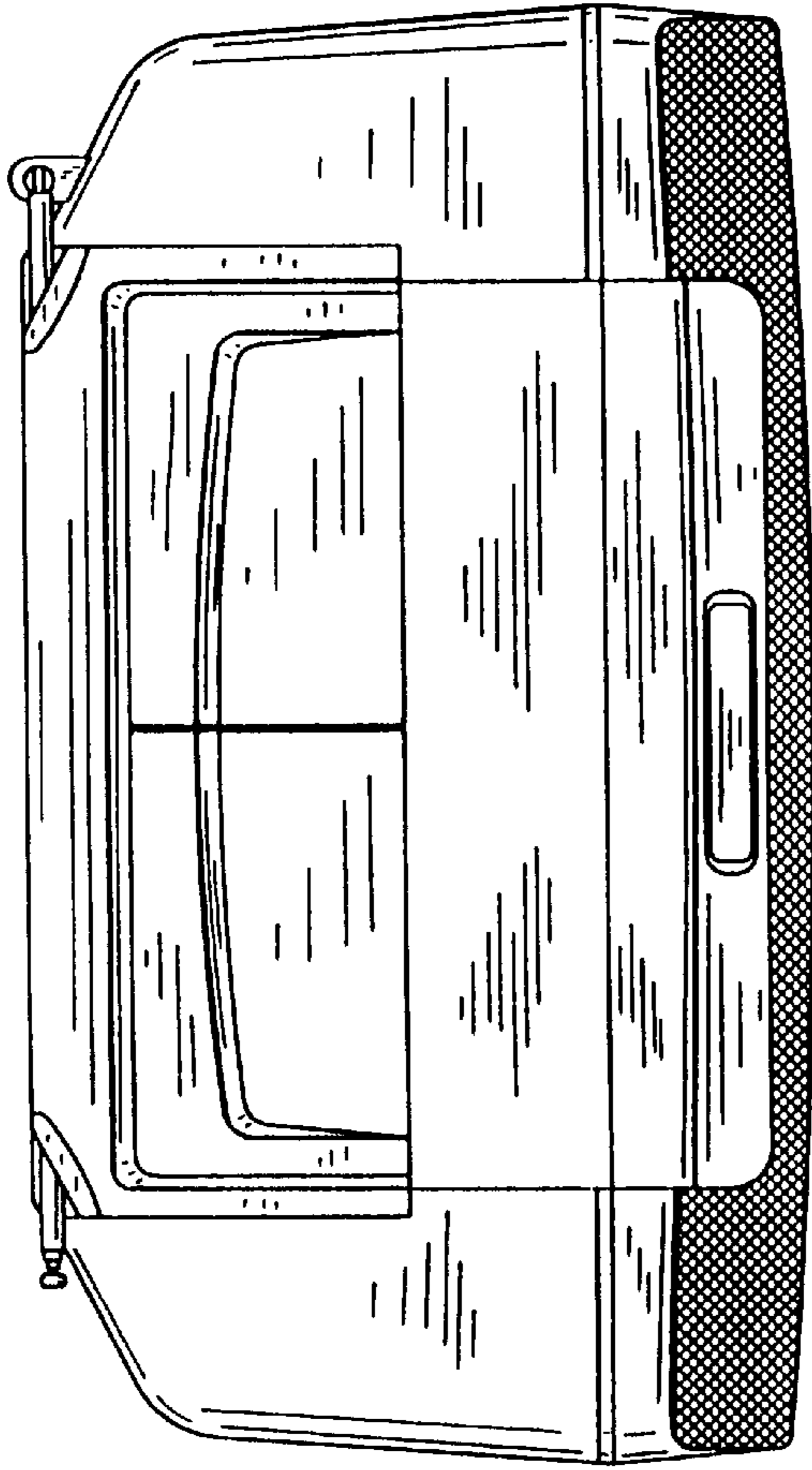

FIG. 4

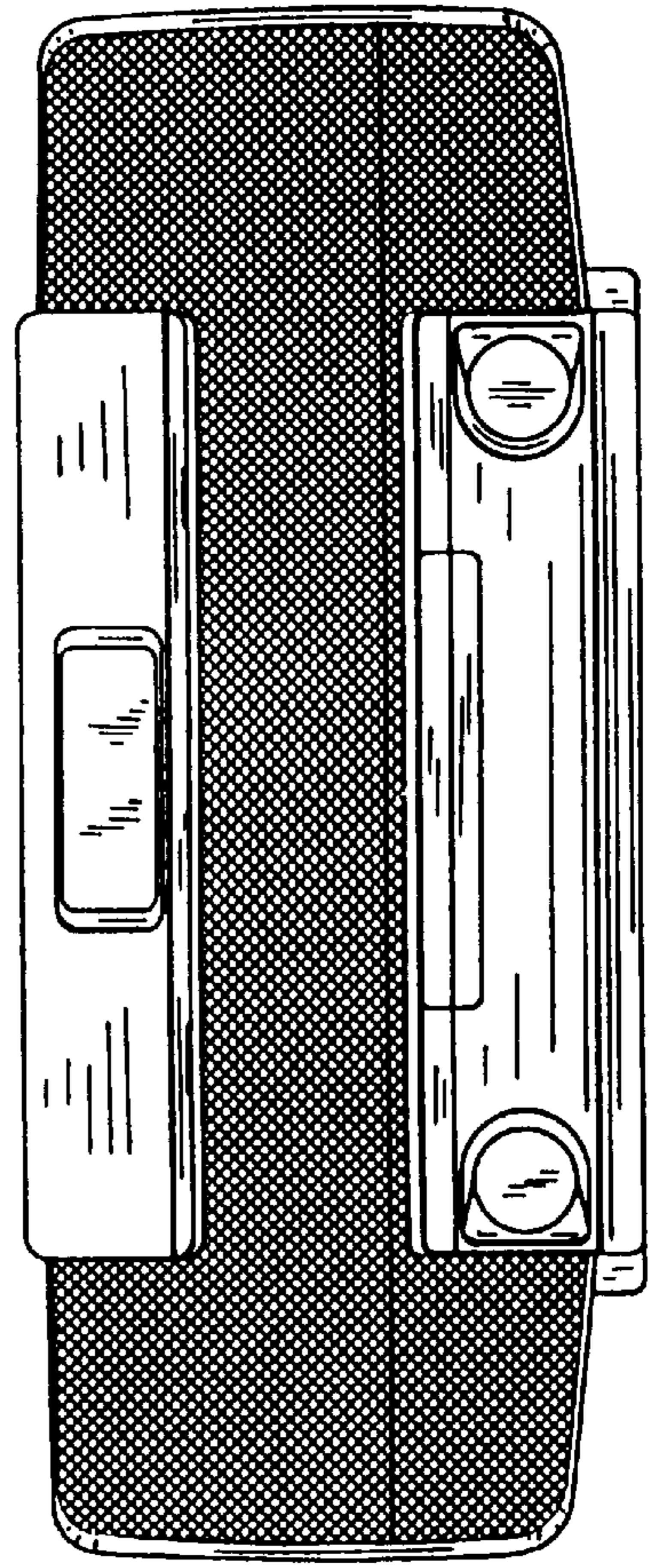

FIG. 3

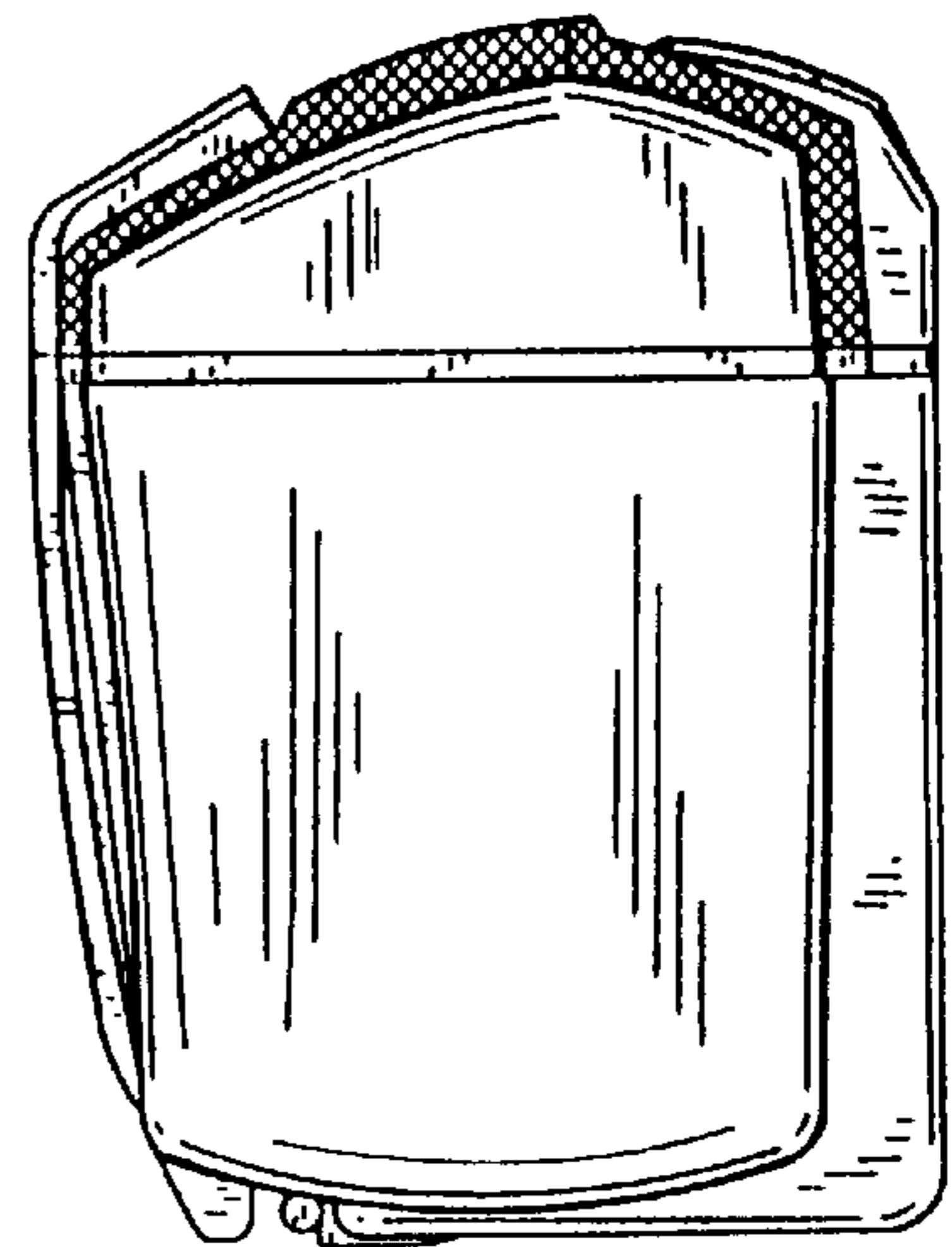

FIG. 6

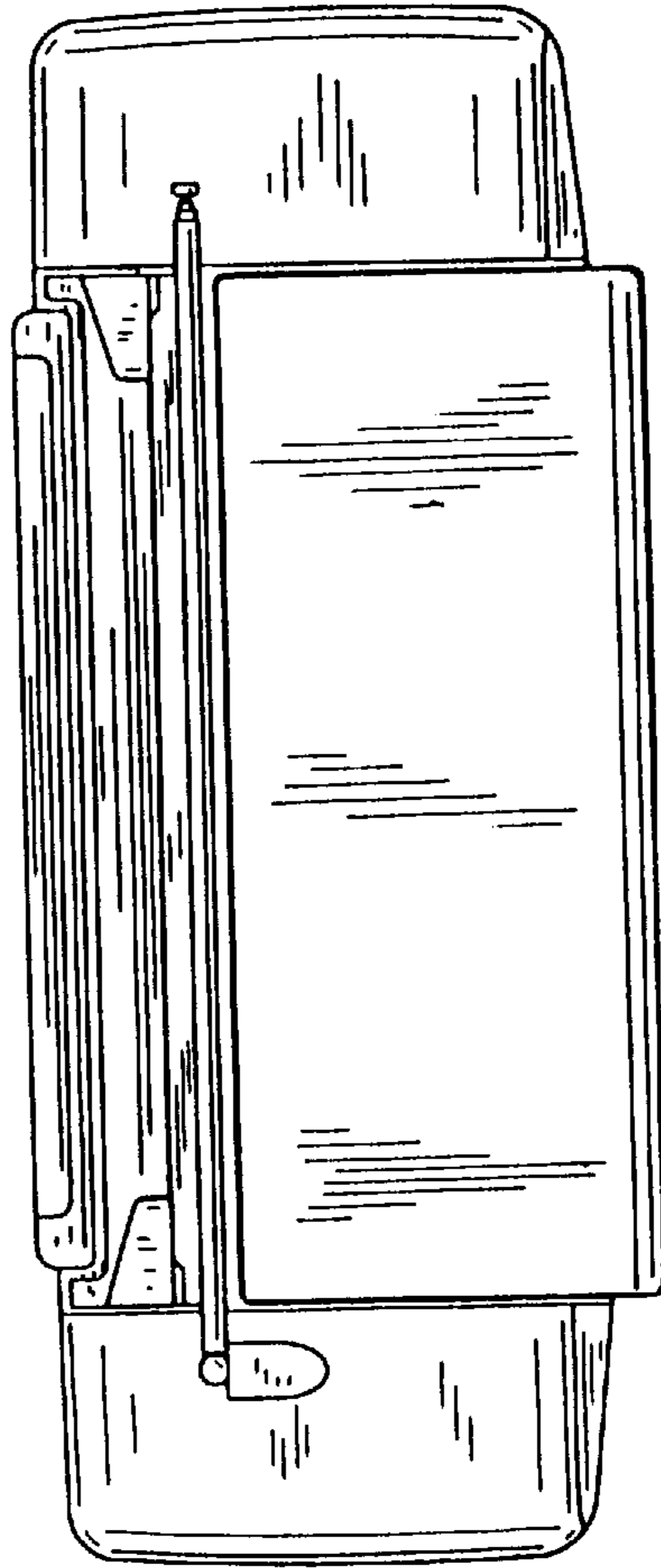

FIG. 5

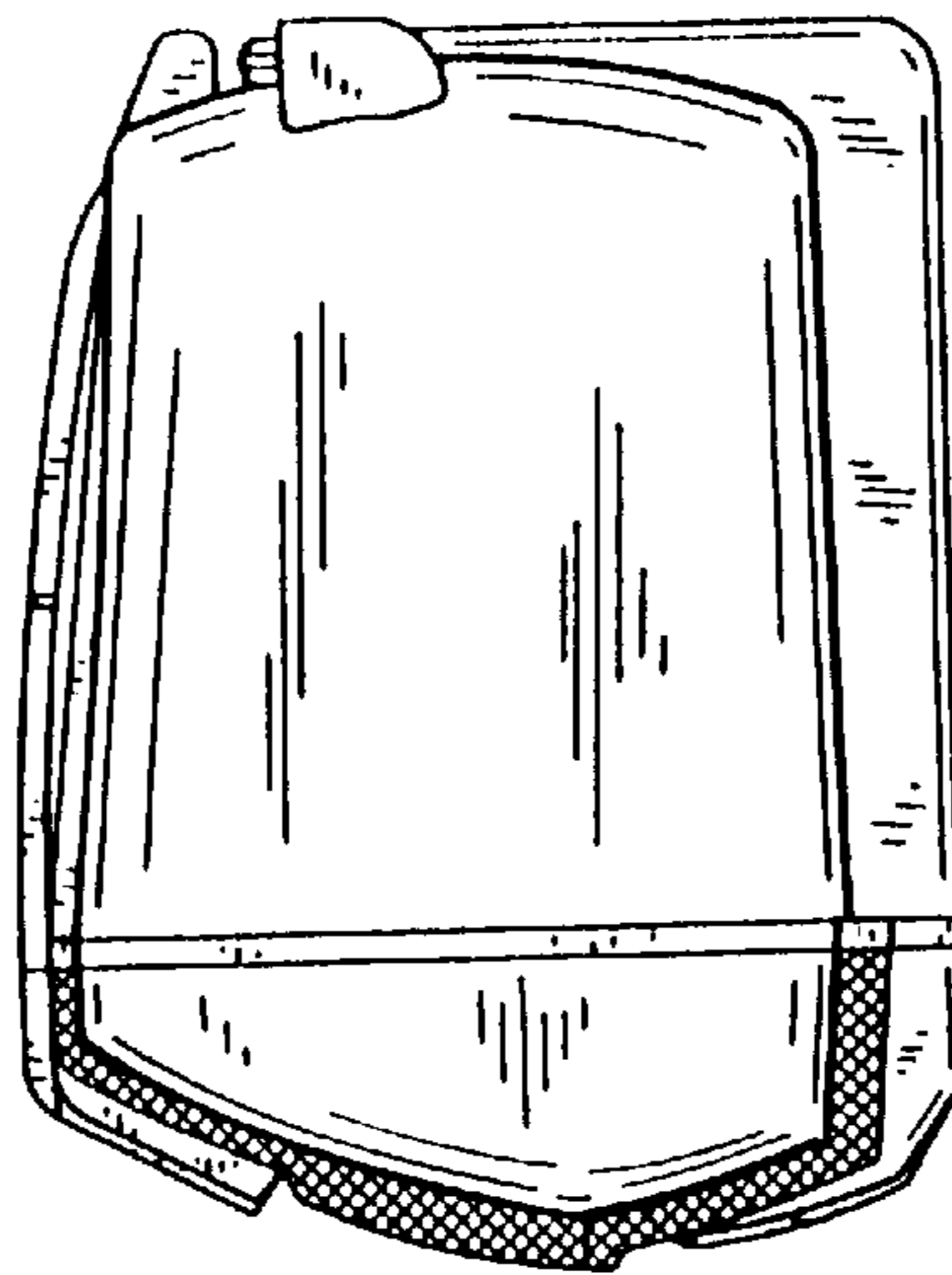

FIG. 7

