



US00D410866S

United States Patent [19]
Philipson et al.

[11] **Patent Number: Des. 410,866**
[45] **Date of Patent: ** Jun. 15, 1999**

[54] **SET OF JAZZ BEADS**

[75] Inventors: **Alan H. Philipson; Andre R. Philipson**, both of New Orleans, La.

[73] Assignee: **Superior Merchandise Company Inc.**, New Orleans, La.

[**] Term: **14 Years**

[21] Appl. No.: **29/092,377**

[22] Filed: **Aug. 18, 1998**

[51] **LOC (6) Cl.** **11-01**

[52] **U.S. Cl.** **D11/8**

[58] **Field of Search** D11/1, 2, 6-18,
D11/40, 44, 48, 50, 79-83, 86, 95-115,
207, 211; 63/1.1, 2, 3; D3/211

[56] **References Cited**

U.S. PATENT DOCUMENTS

D. 118,378	1/1940	Mann	D11/8
D. 163,023	4/1951	Cassel	D11/48
D. 260,086	8/1981	Lambert	D11/8
D. 300,612	4/1989	Lau	D11/44
D. 326,554	6/1992	Meyers, Jr. et al.	D11/81
D. 342,917	1/1994	Arman	D11/48
D. 344,041	2/1994	Arman	D11/44

Primary Examiner—Ralf Seifert

Attorney, Agent, or Firm—Nixon & Vanderhye P.C.

[57] **CLAIM**

The ornamental design for a “set of jazz beads”, as shown and described.

DESCRIPTION

FIG. 1 is a perspective view of a set of jazz beads showing my new design in a position of use, the broken line showing of a necklace is for illustrative purposes only and forms no part of the claimed design;

FIG. 2 is a perspective view of one bead which simulates a clarinet;

FIG. 3 is a top plan view of FIG. 2;

FIG. 4 is a front elevational view of FIG. 2;

FIG. 5 is a side elevational view of FIG. 2, the opposite side view being a mirror image;

FIG. 6 is a rear elevational view of FIG. 2;

FIG. 7 is a bottom plan view of FIG. 2;

FIG. 8 is a perspective view of one bead which simulates a saxophone;

FIG. 9 is a top plan view of FIG. 8;

FIG. 10 is a front elevational view of FIG. 8;

FIG. 11 is a side elevational view of FIG. 8, the opposite side being a mirror image;

FIG. 12 is a rear elevational view of FIG. 8;

FIG. 13 is a bottom plan view of FIG. 8;

FIG. 14 is a perspective view of one bead which simulates a drum;

FIG. 15 is a top plan view of FIG. 14;

FIG. 16 is a front elevational view of FIG. 14;

FIG. 17 is a left side elevational view of FIG. 14;

FIG. 18 is a right side elevational view of FIG. 14;

FIG. 19 is a bottom plan view of FIG. 14;

FIG. 20 is a rear elevational view of FIG. 14;

FIG. 21 is a perspective view of one bead which simulates a piano;

FIG. 22 is a top plan view of FIG. 21;

FIG. 23 is a left side elevational view of FIG. 21;

FIG. 24 is a front elevational view of FIG. 21;

FIG. 25 is a rear elevational view of FIG. 21;

FIG. 26 is a bottom plan view of FIG. 21;

FIG. 27 is a right side elevational view of FIG. 21;

FIG. 28 is a perspective view of one bead which simulates a trumpet;

FIG. 29 is a top plan view of FIG. 28;

FIG. 30 is a front elevational view of FIG. 28;

FIG. 31 is a left side elevational view of FIG. 28;

FIG. 32 is a right side elevational view of FIG. 28;

FIG. 33 is a rear elevational view of FIG. 28; and,

FIG. 34 is a bottom plan view of FIG. 28.

1 Claim, 8 Drawing Sheets

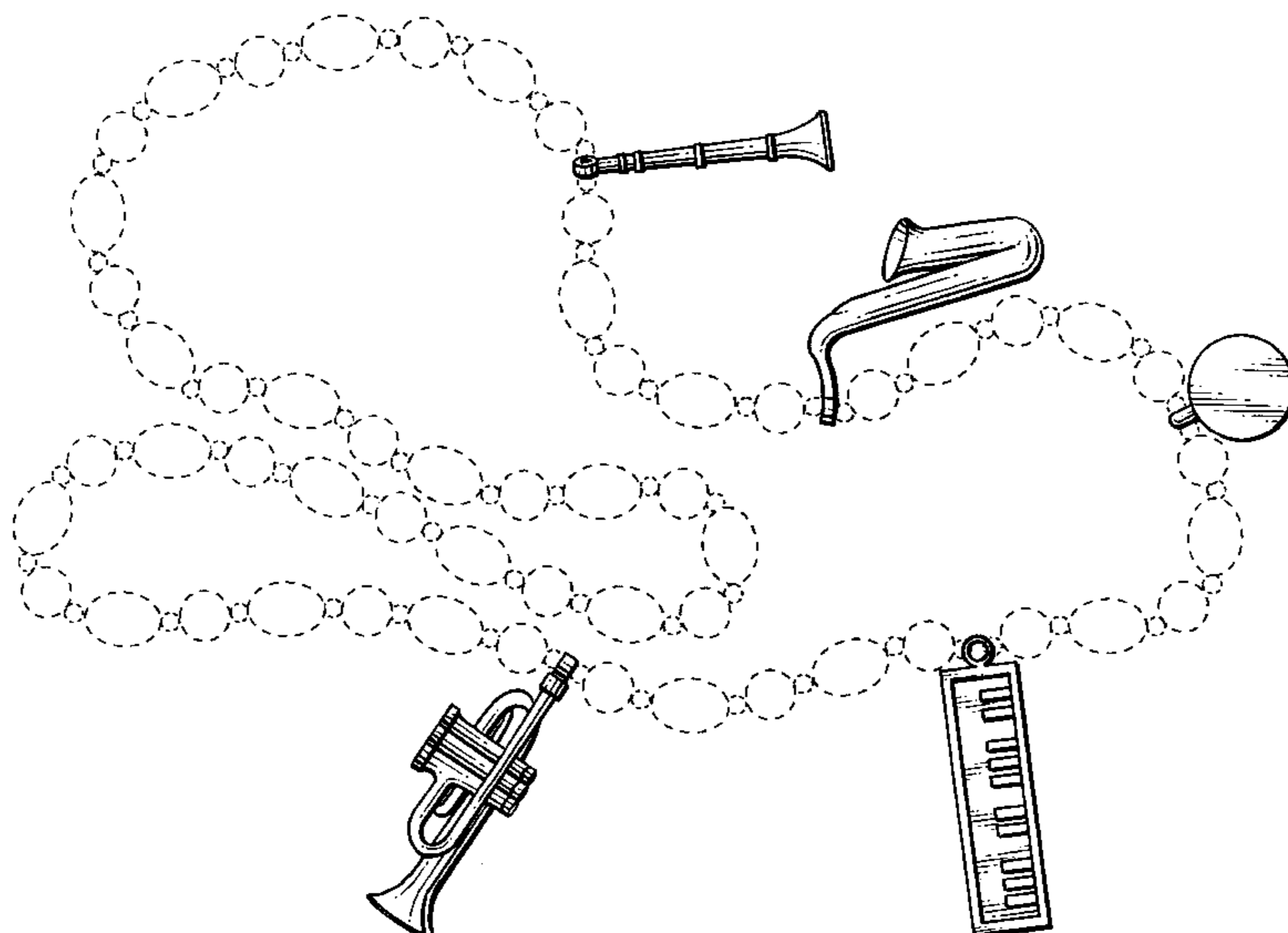
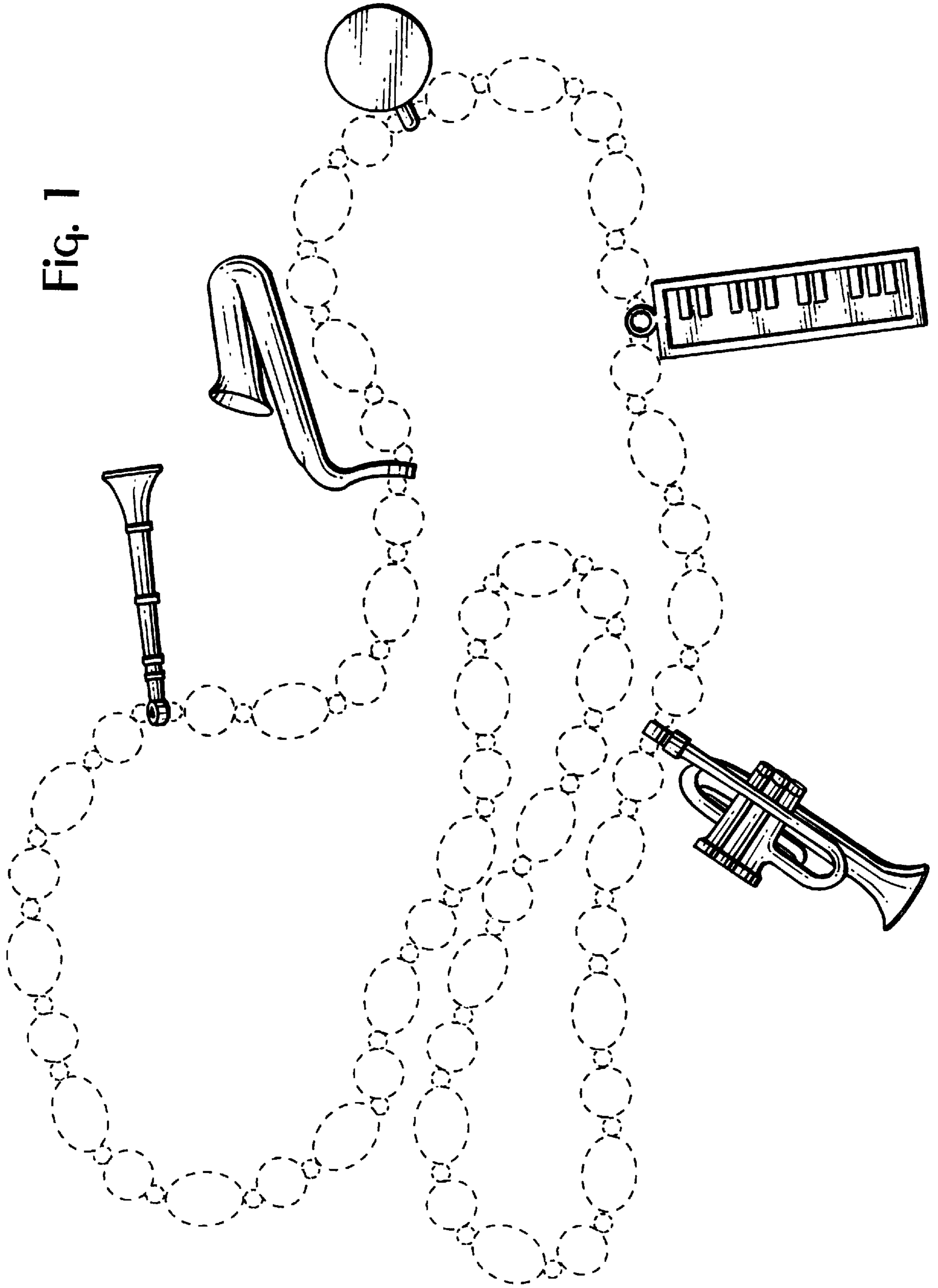

Fig. 1



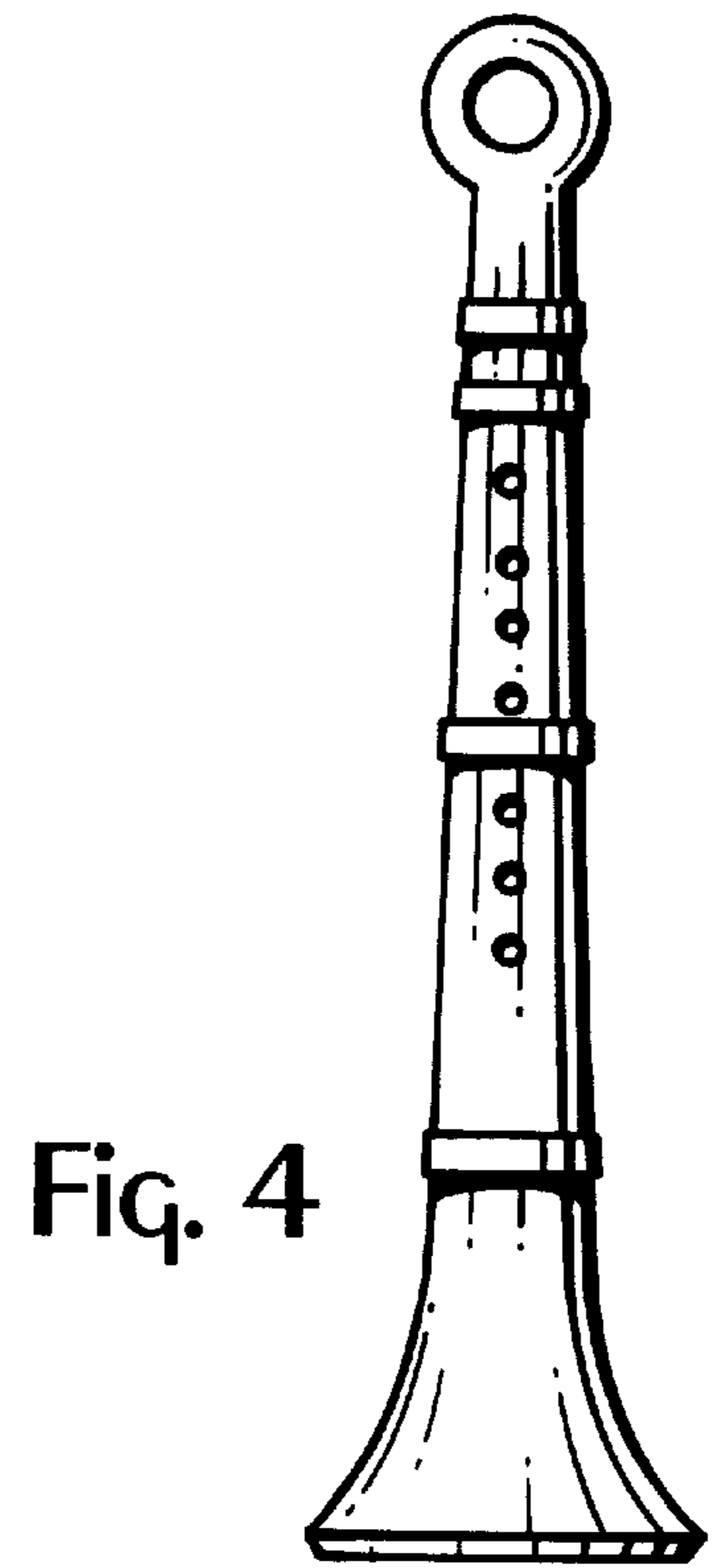
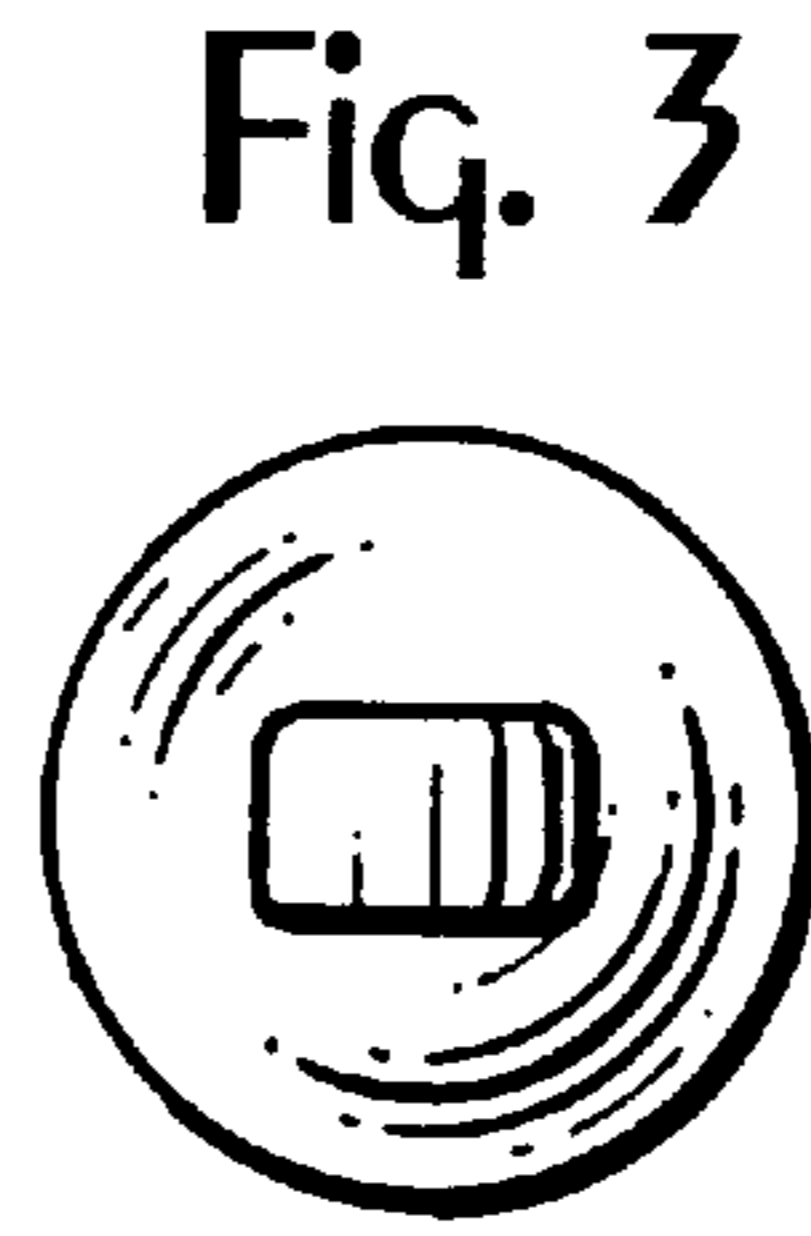
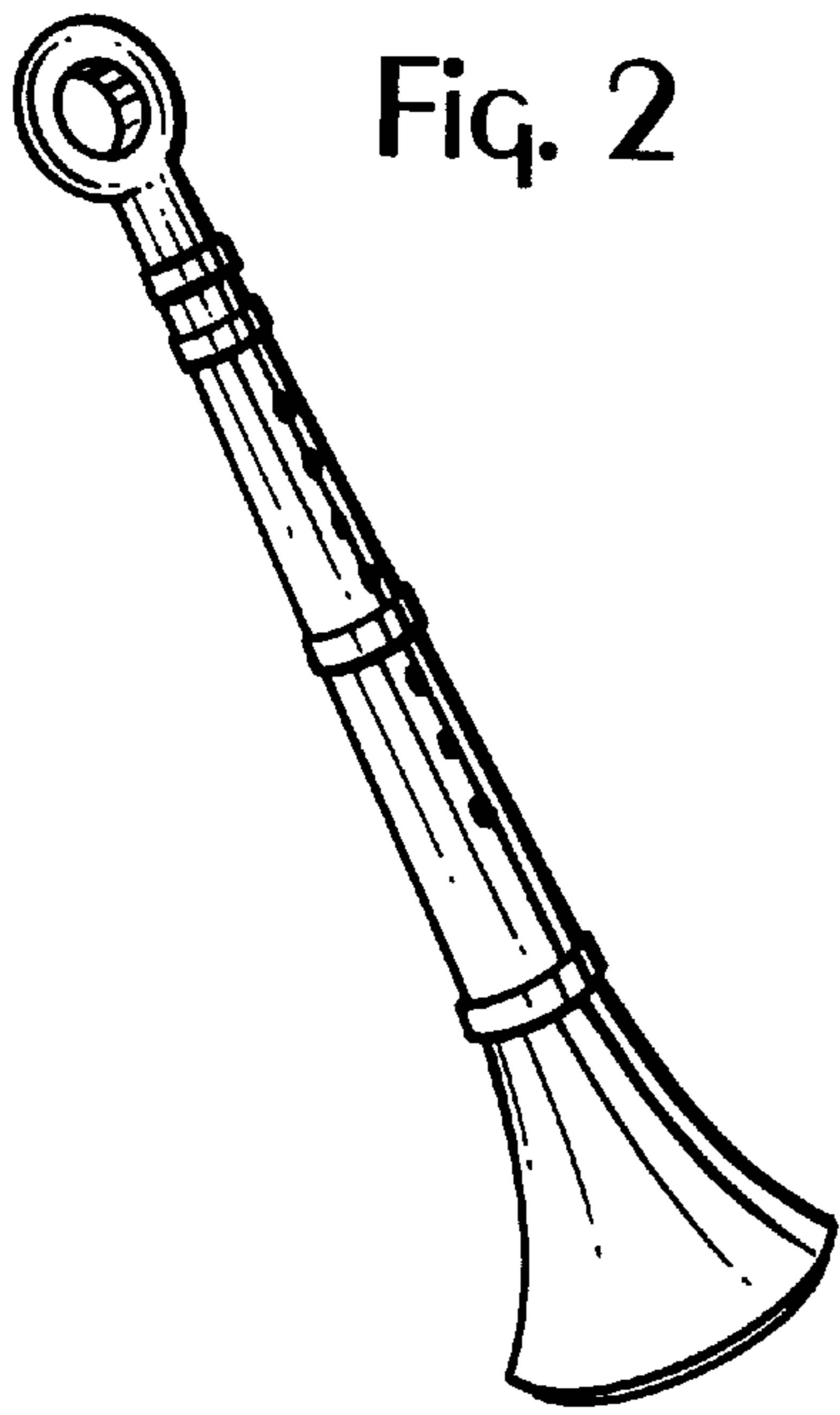

Fig. 5

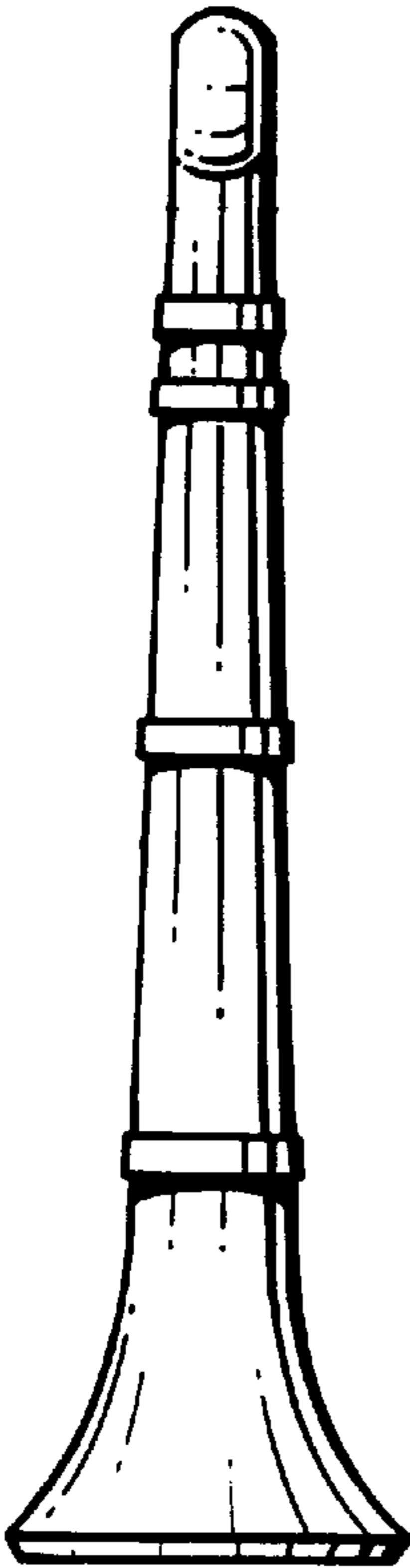

Fig. 6

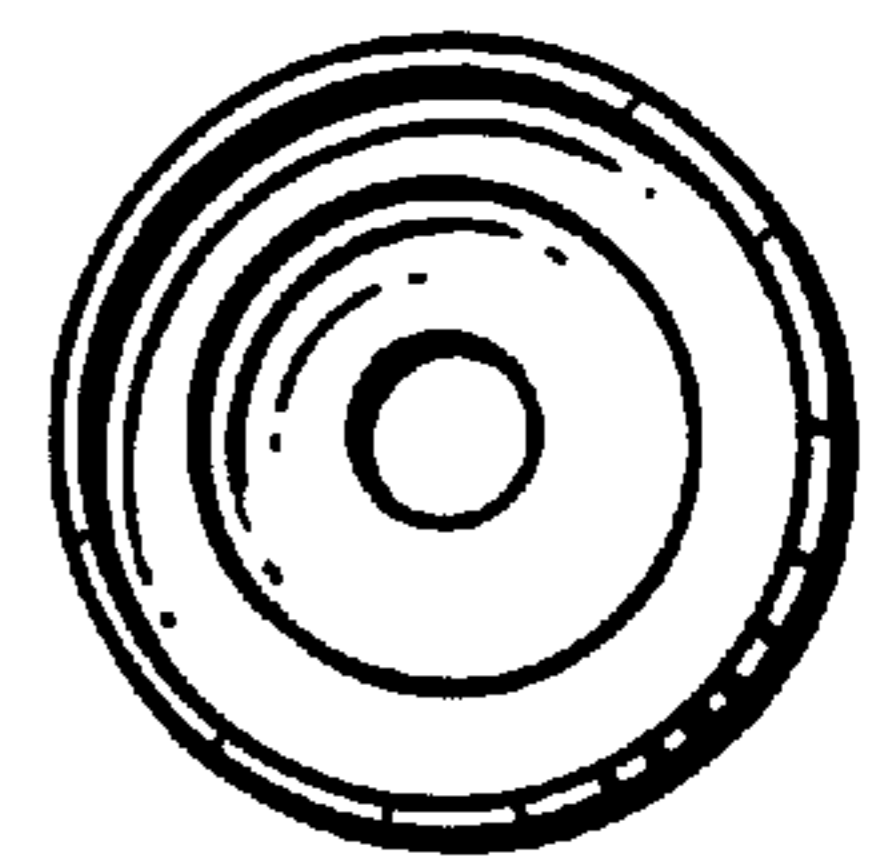
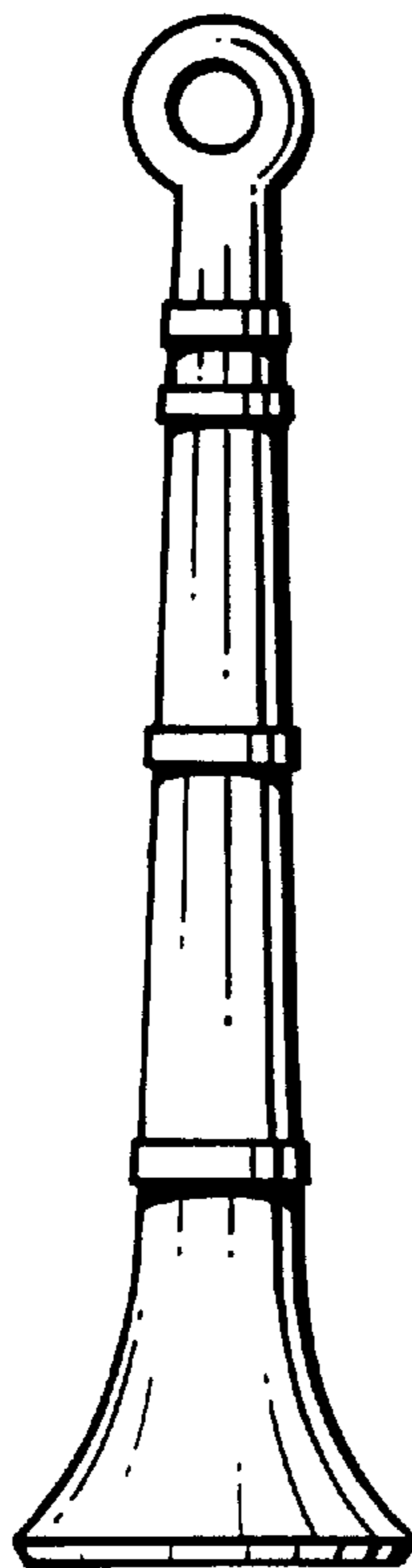

Fig. 7

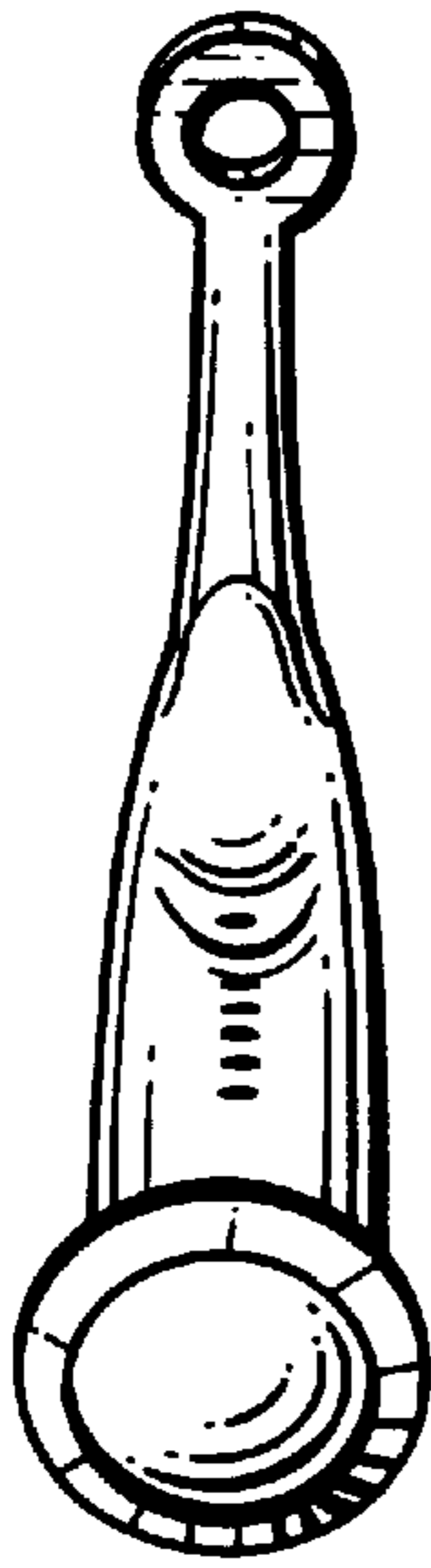

Fig. 9

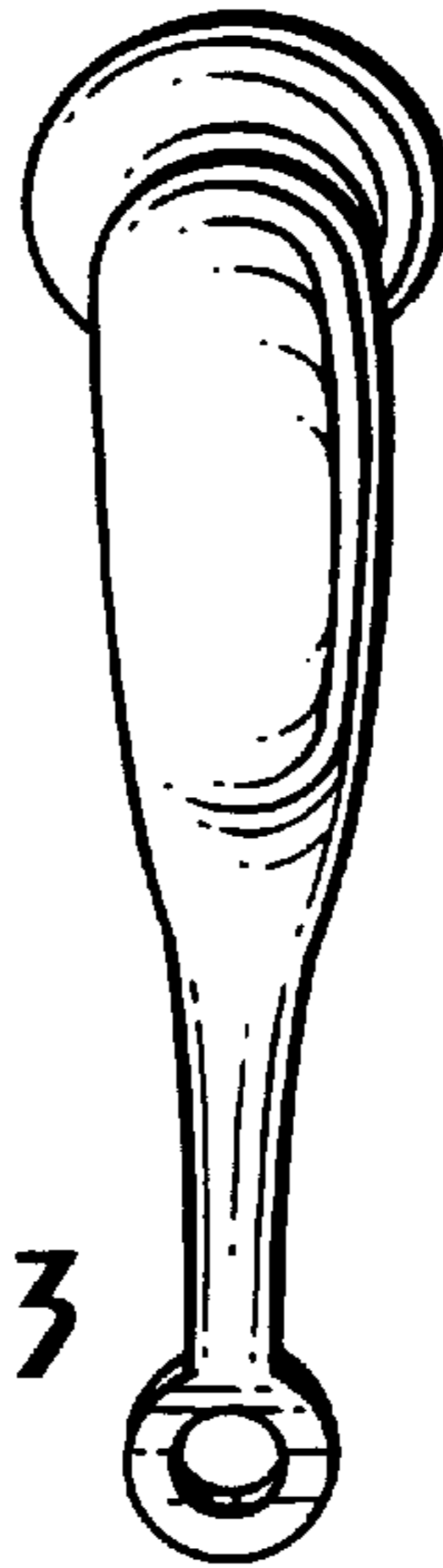

Fig. 13

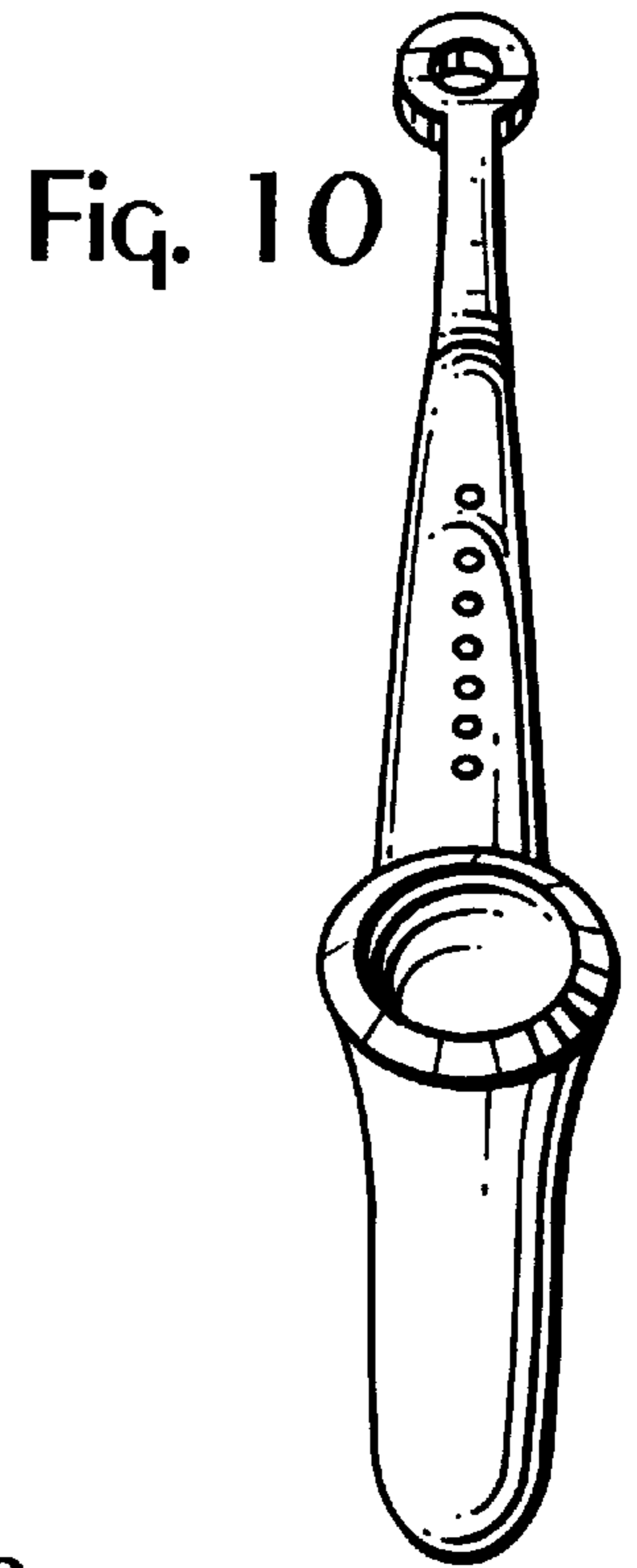

Fig. 10

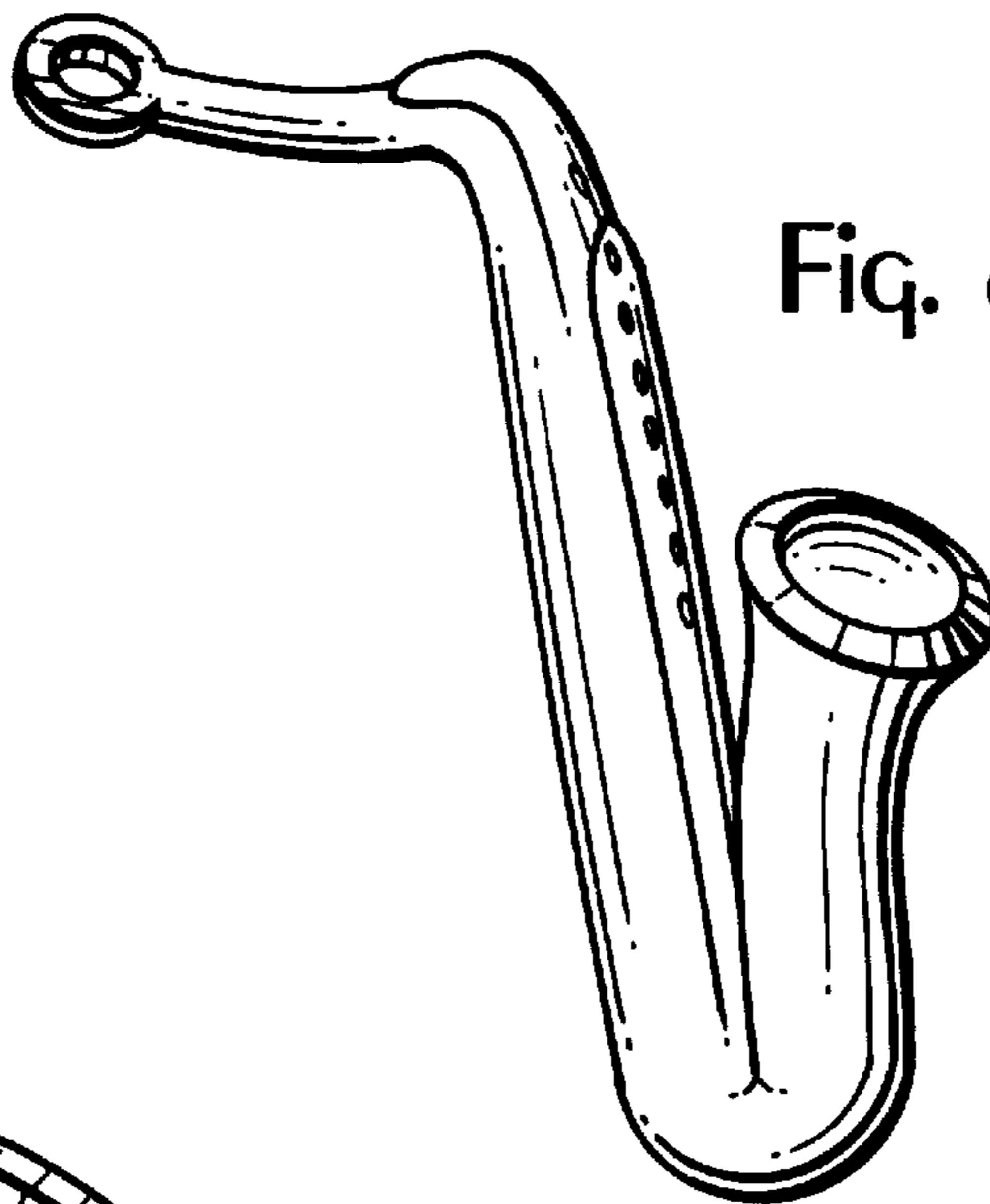

Fig. 8



Fig. 11

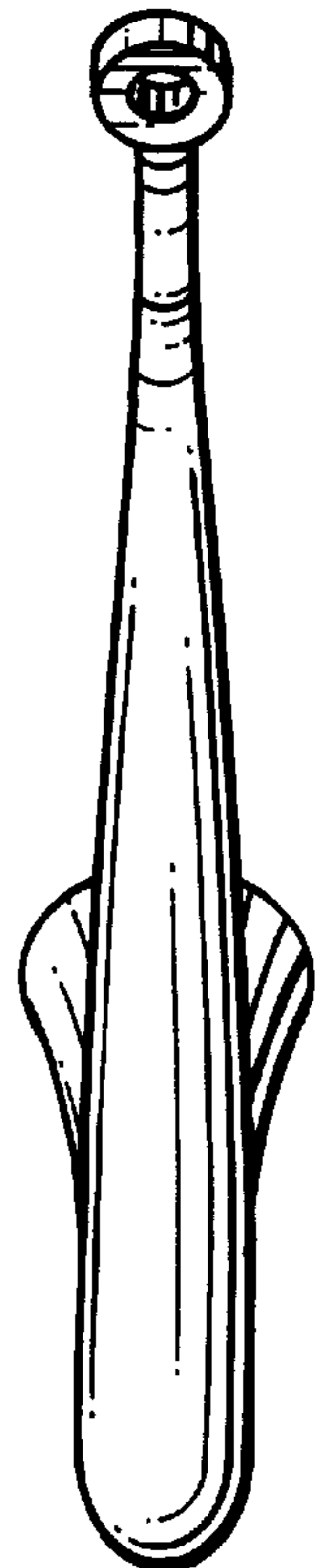

Fig. 12

Fig. 15

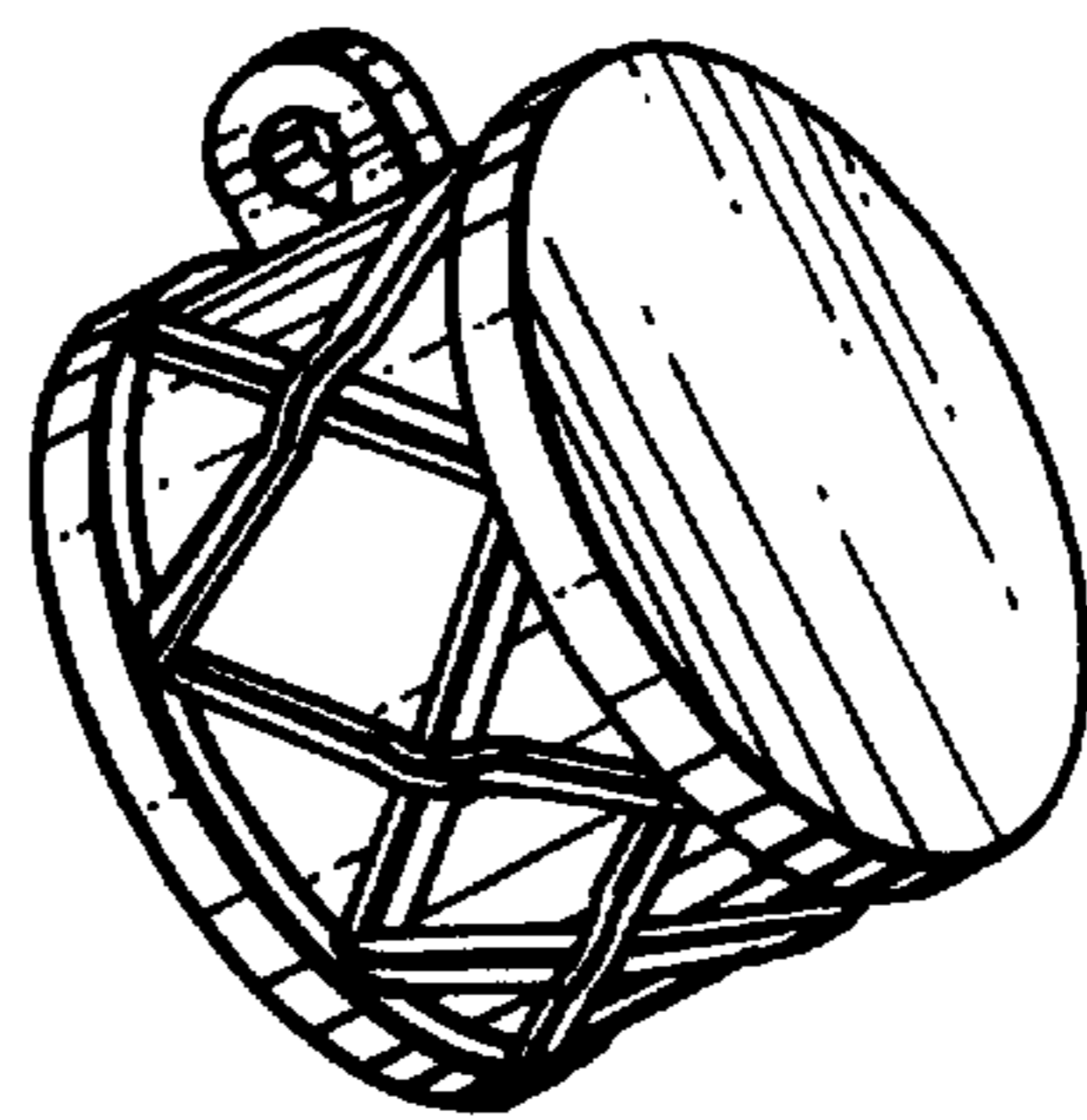
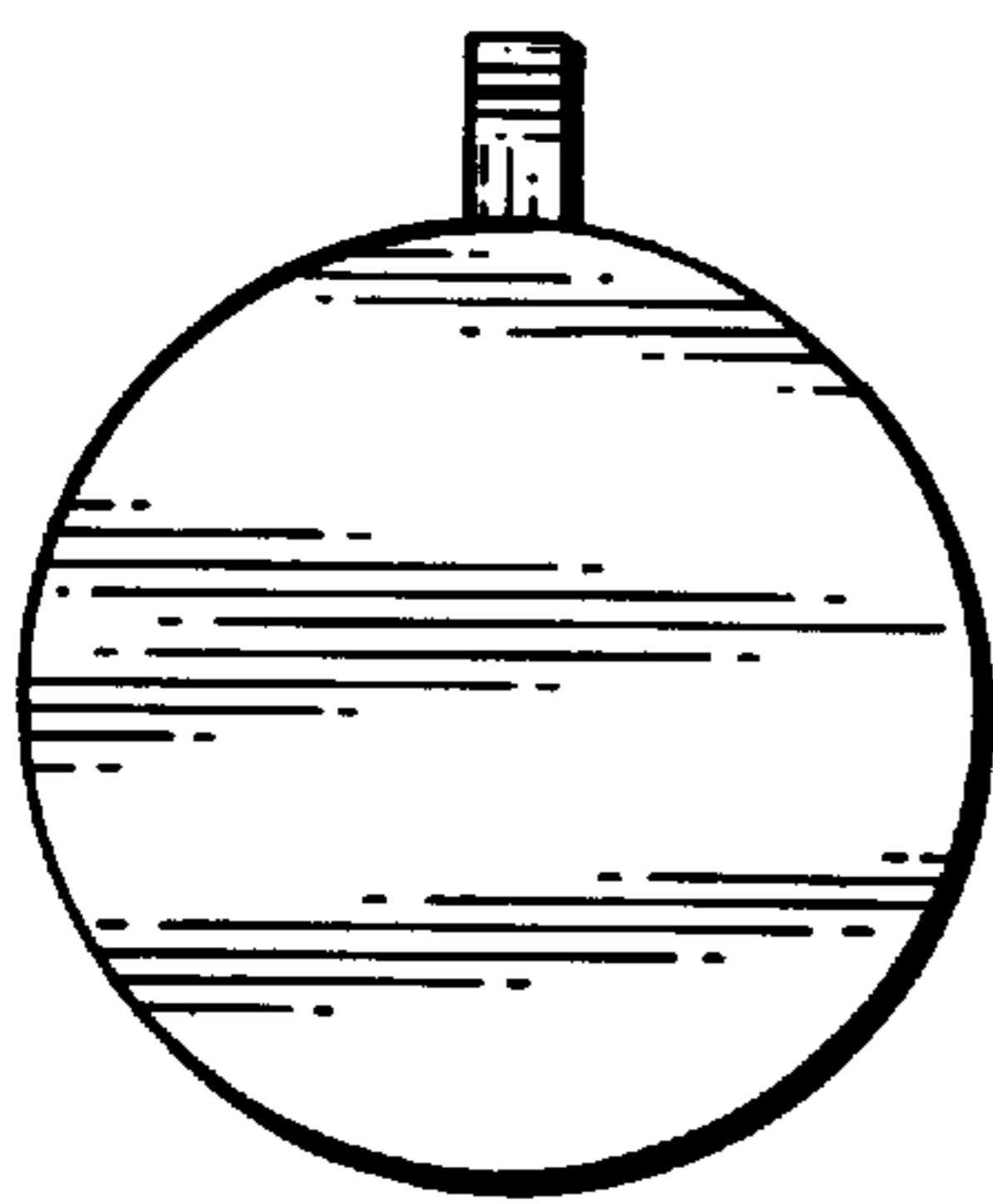

Fig. 14

Fig. 19

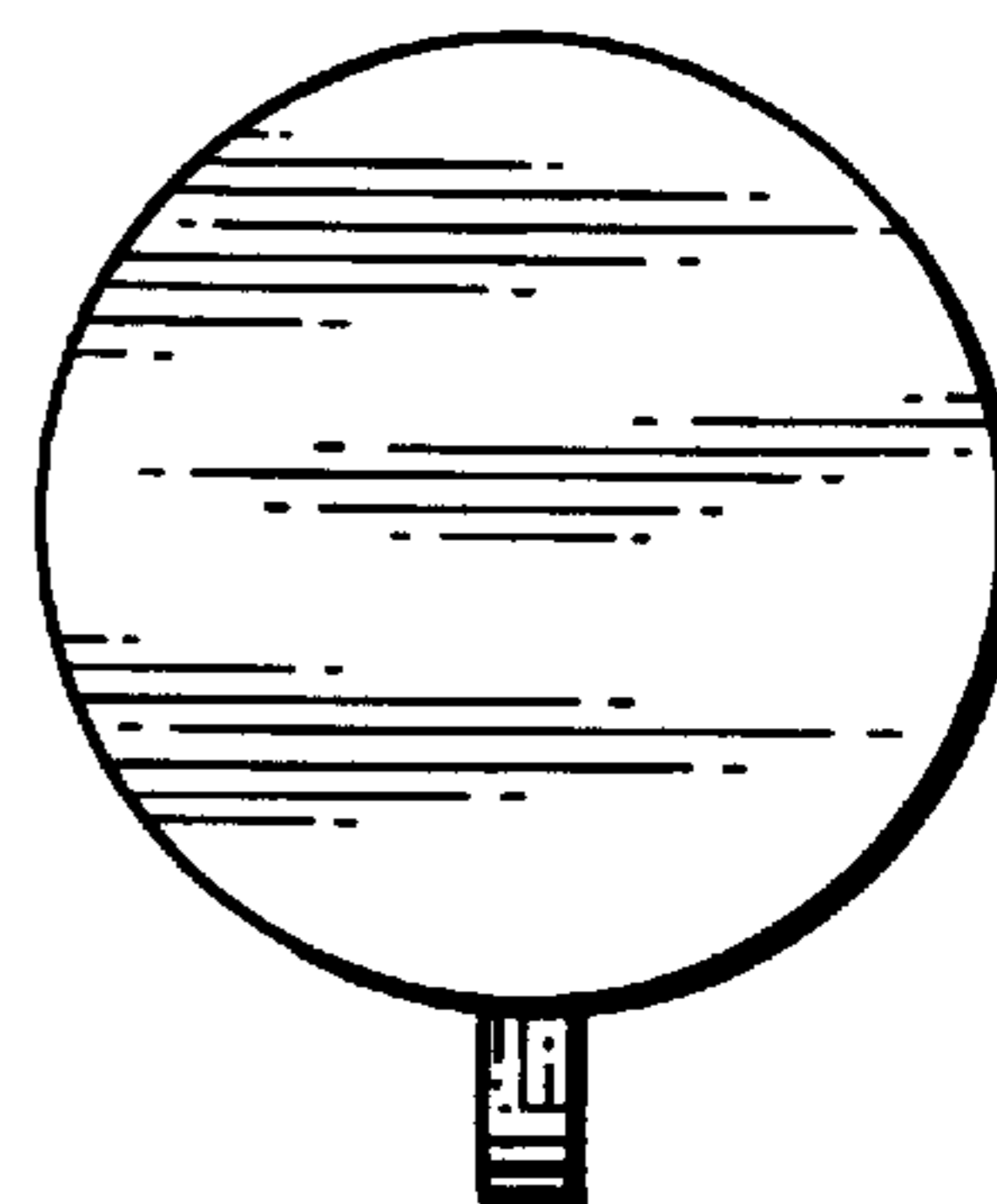

Fig. 16

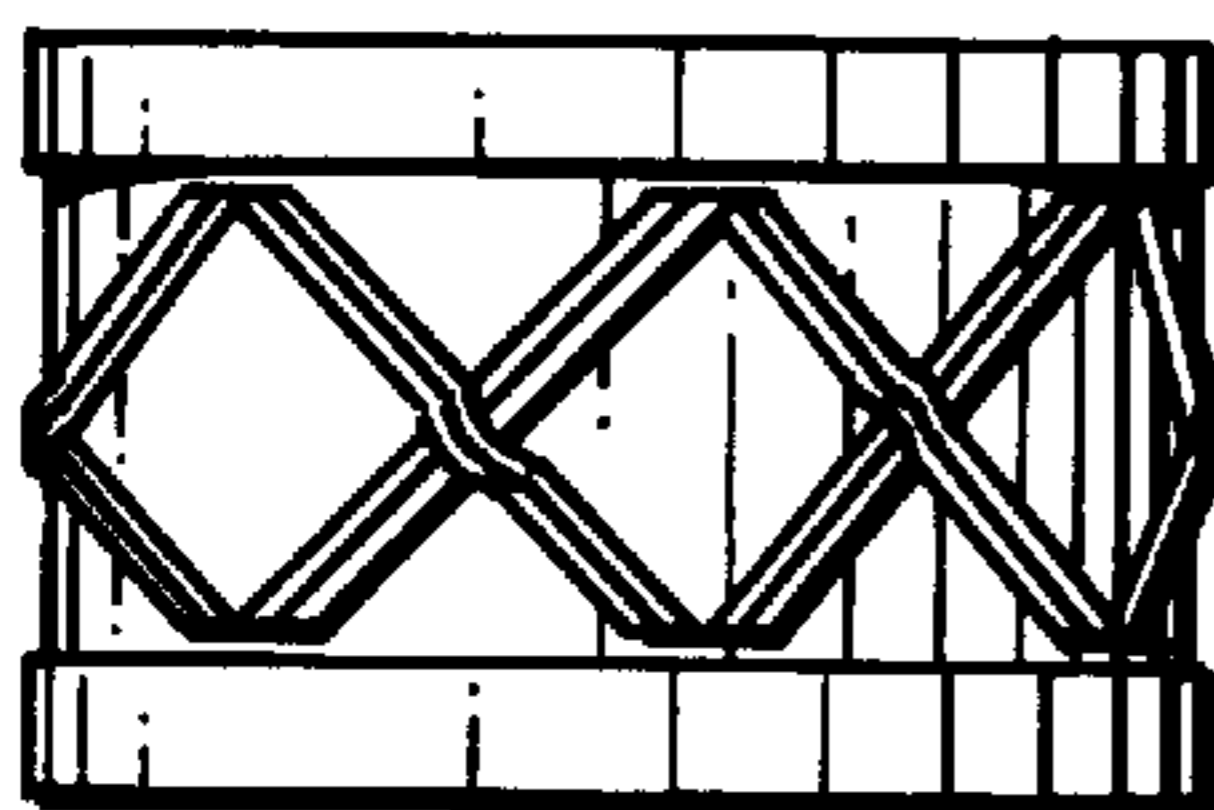

Fig. 18

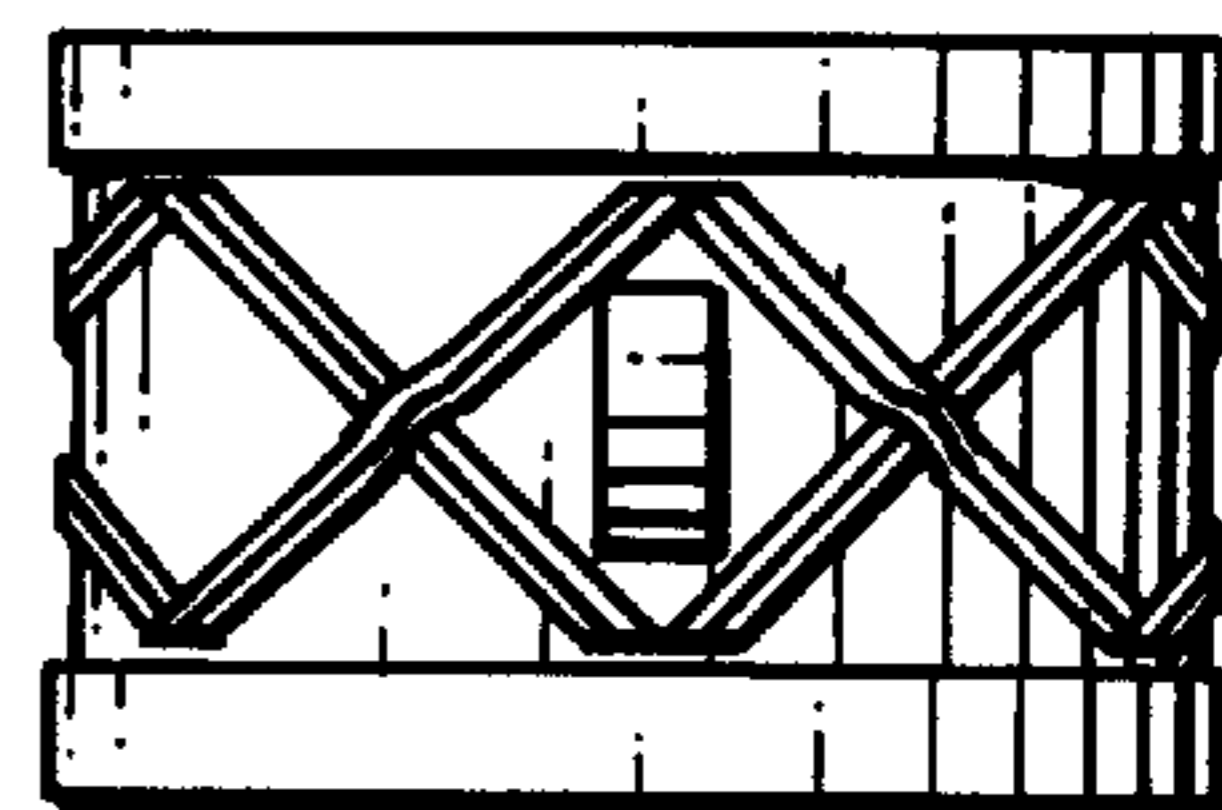

Fig. 17

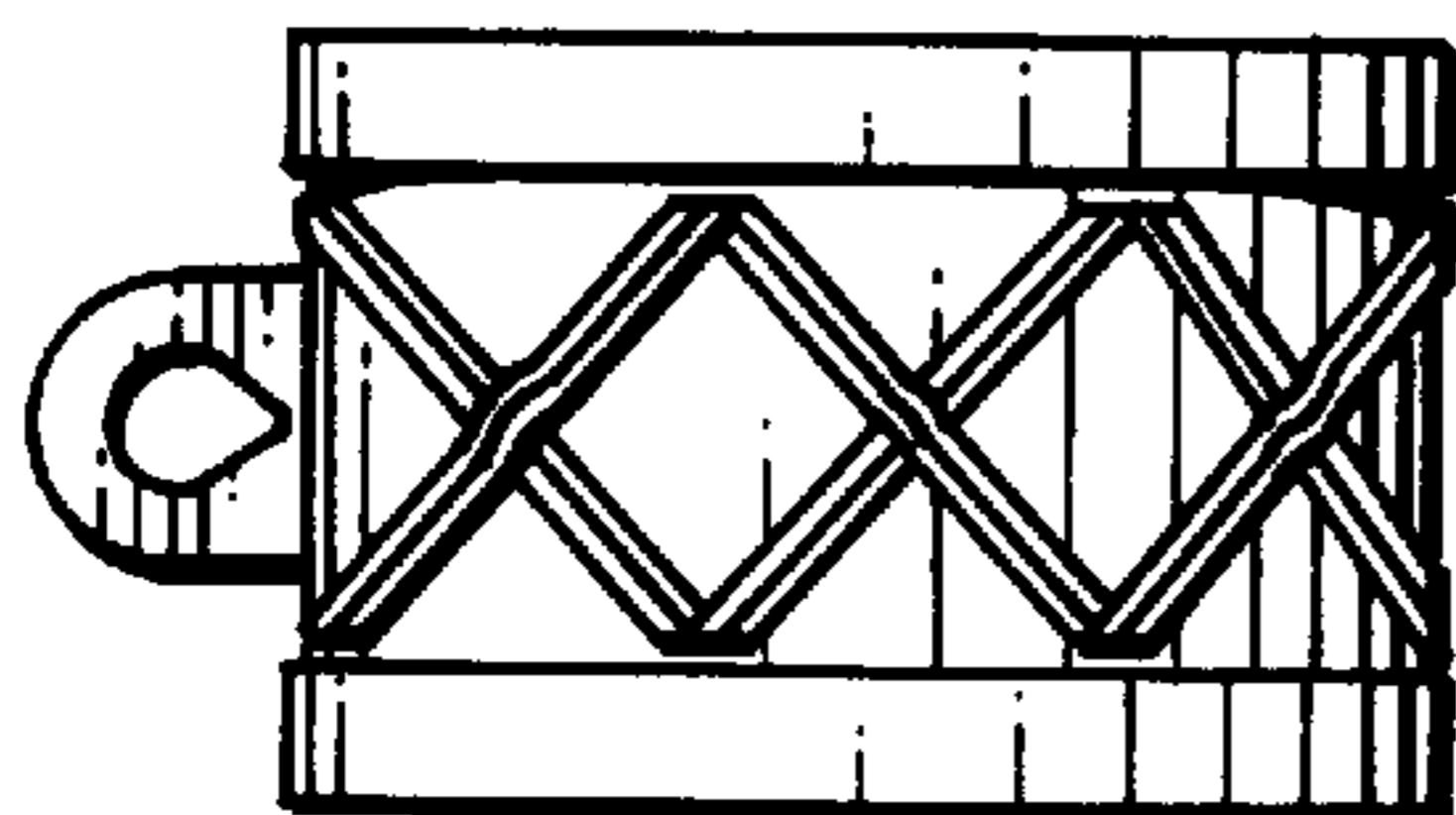
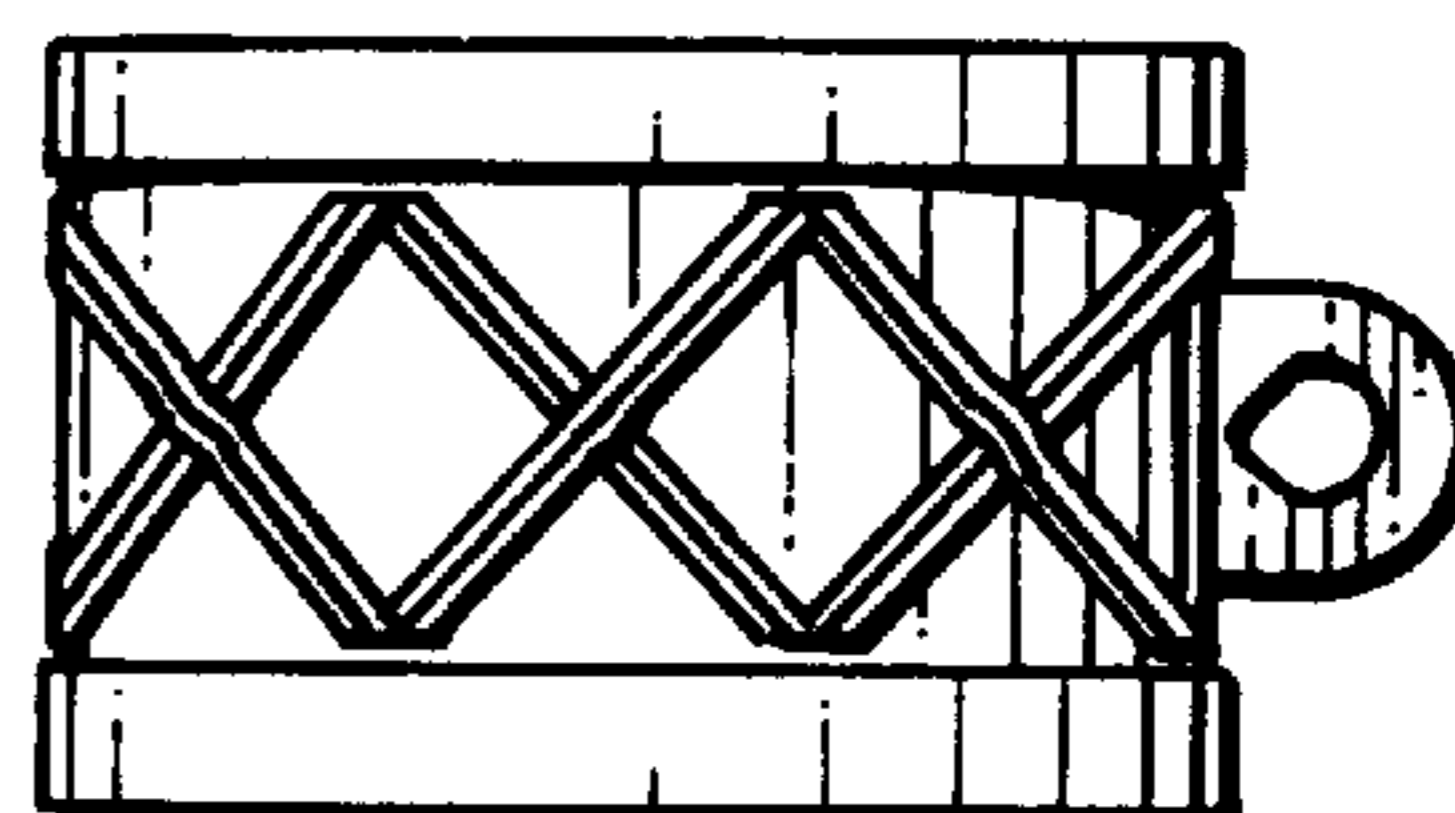

Fig. 20



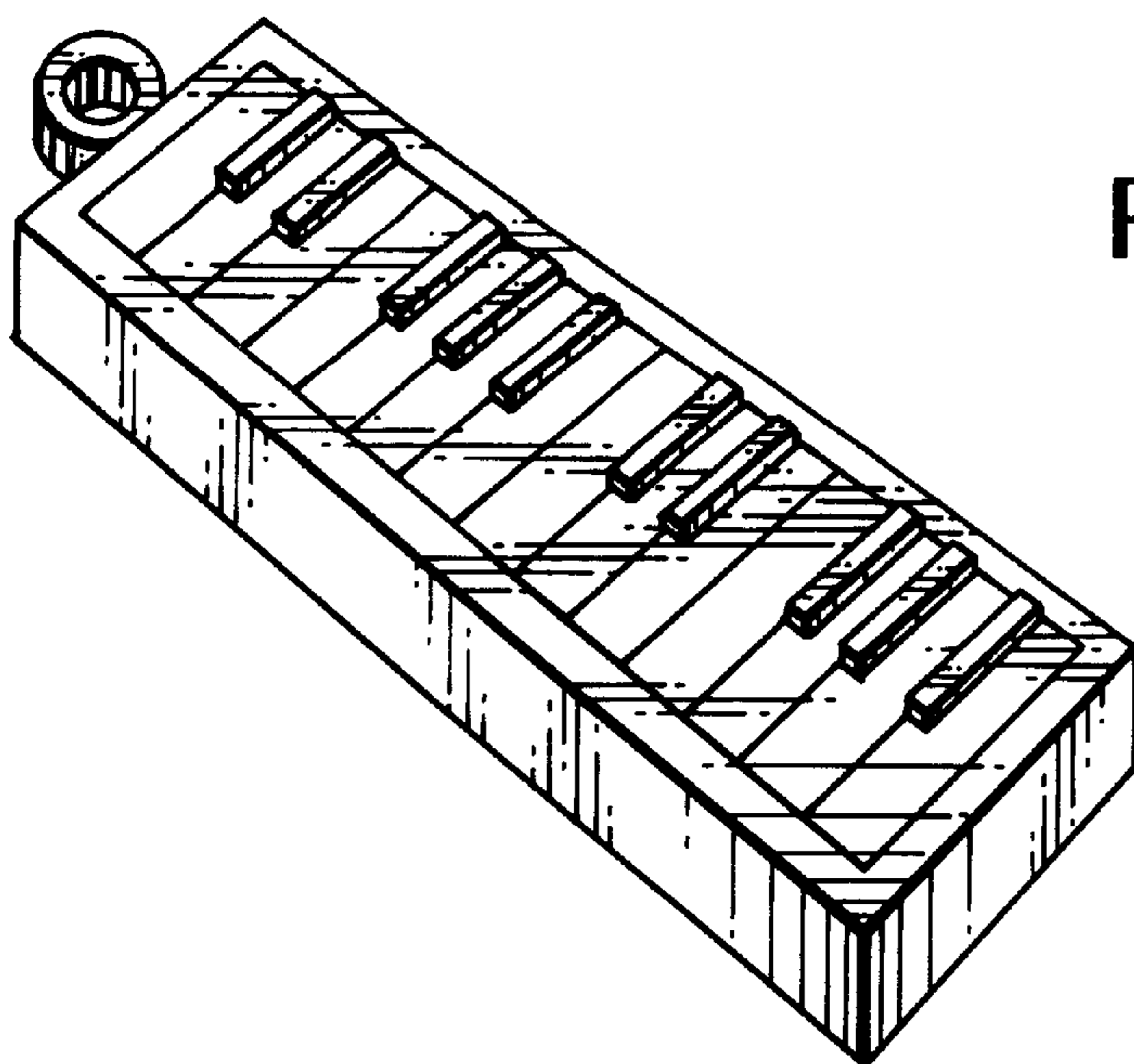

Fig. 21

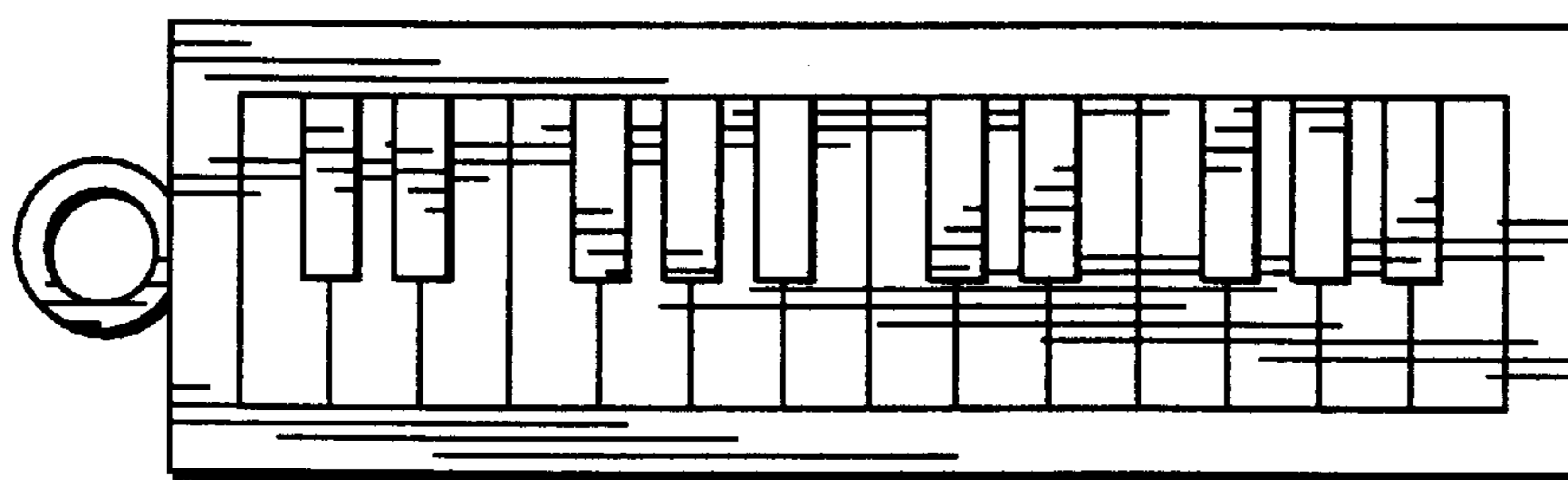

Fig. 22



Fig. 23

Fig. 24

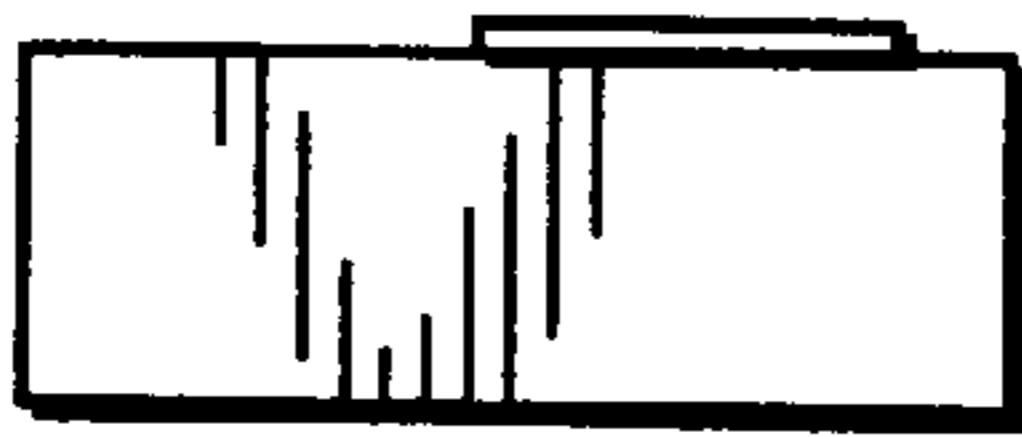

Fig. 25

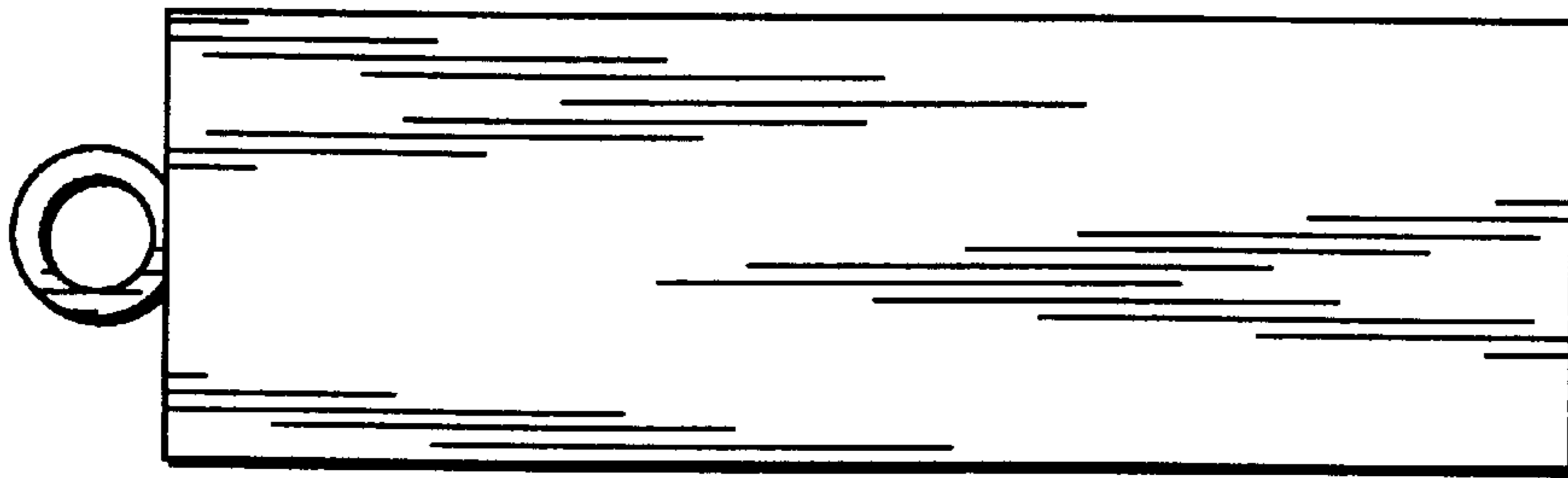

Fig. 26

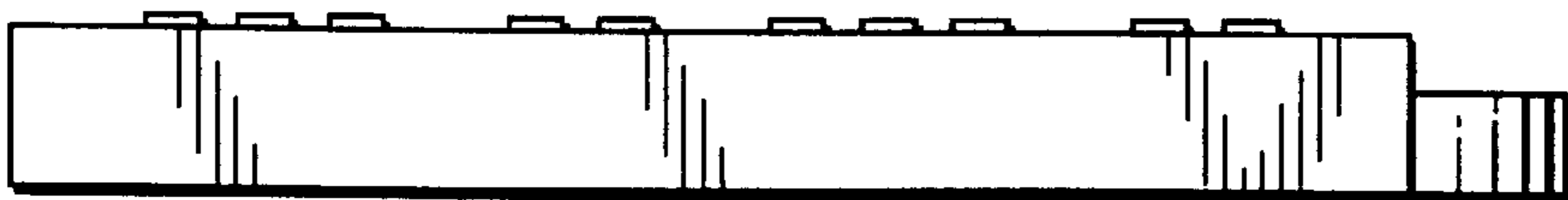

Fig. 27

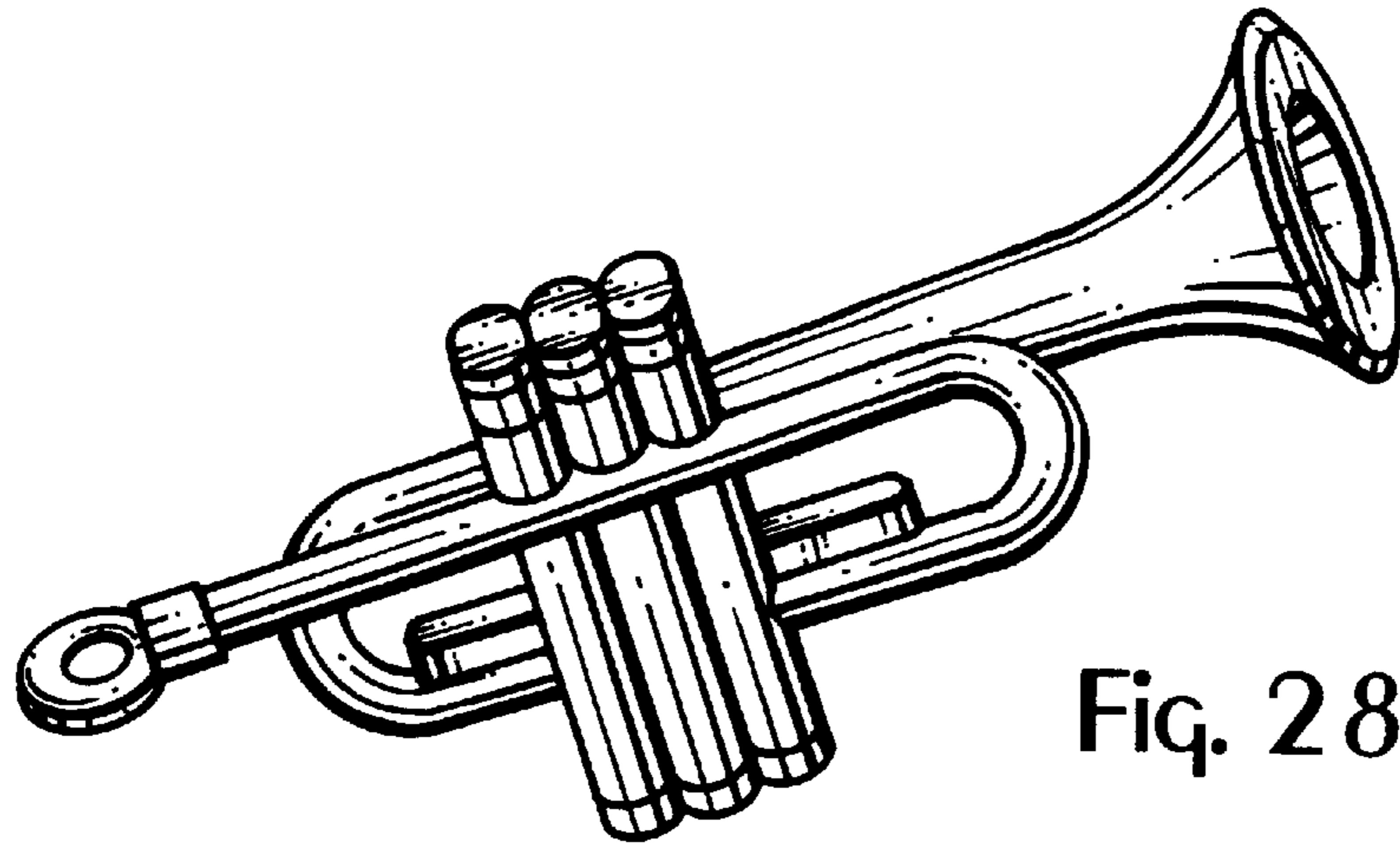

Fig. 28

Fig. 29

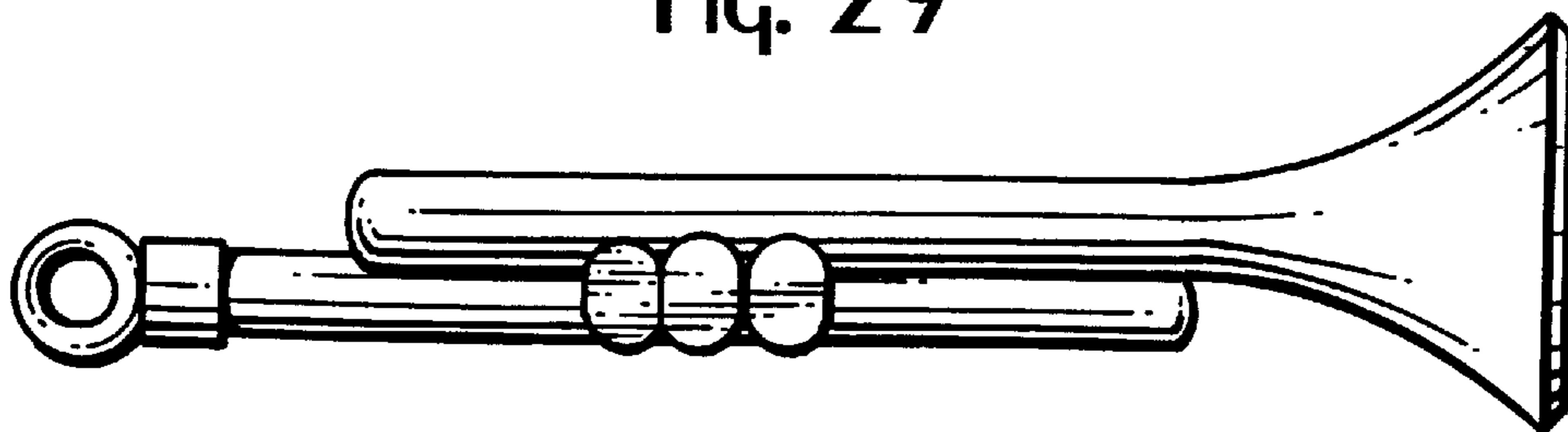

Fig. 34

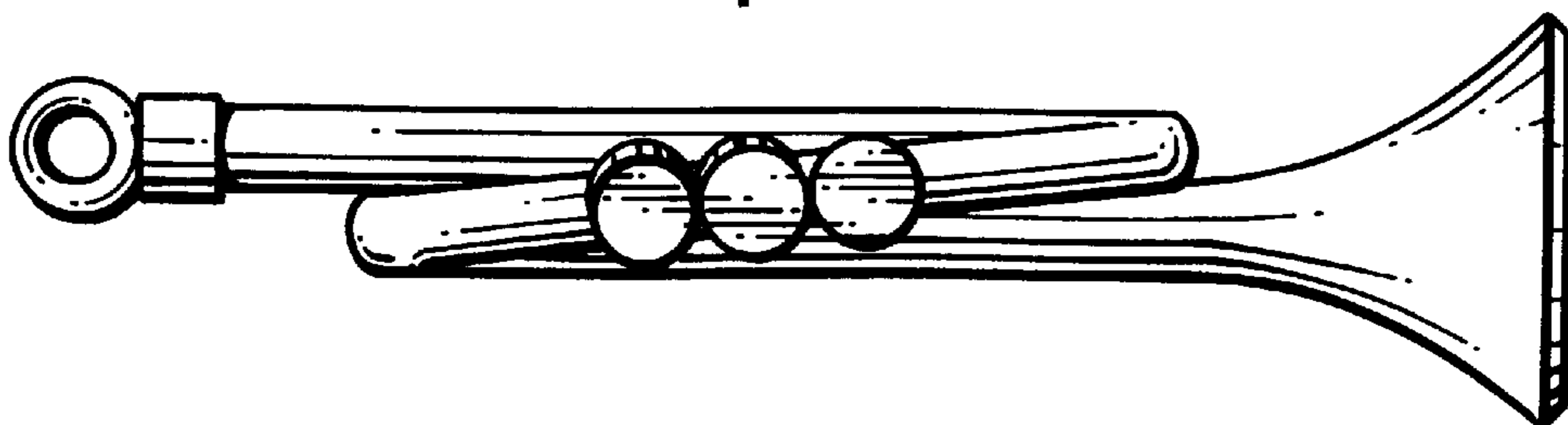

Fig. 30

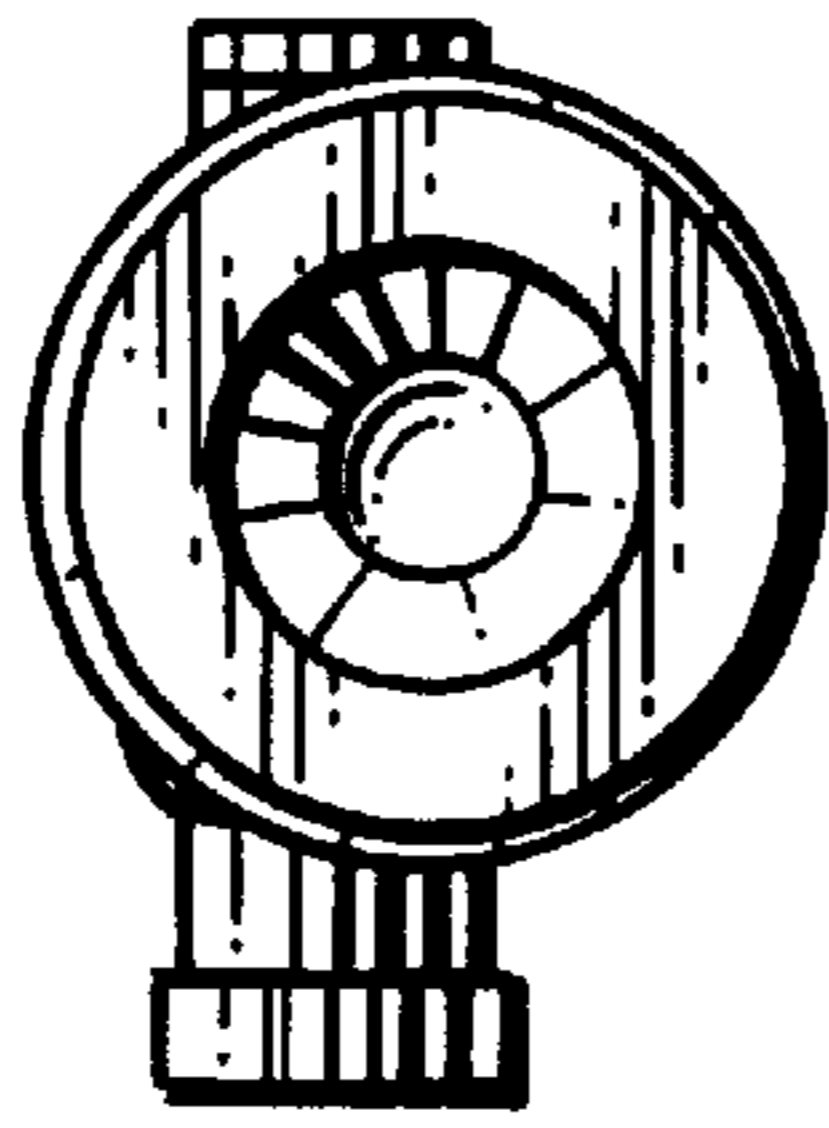

Fig. 33

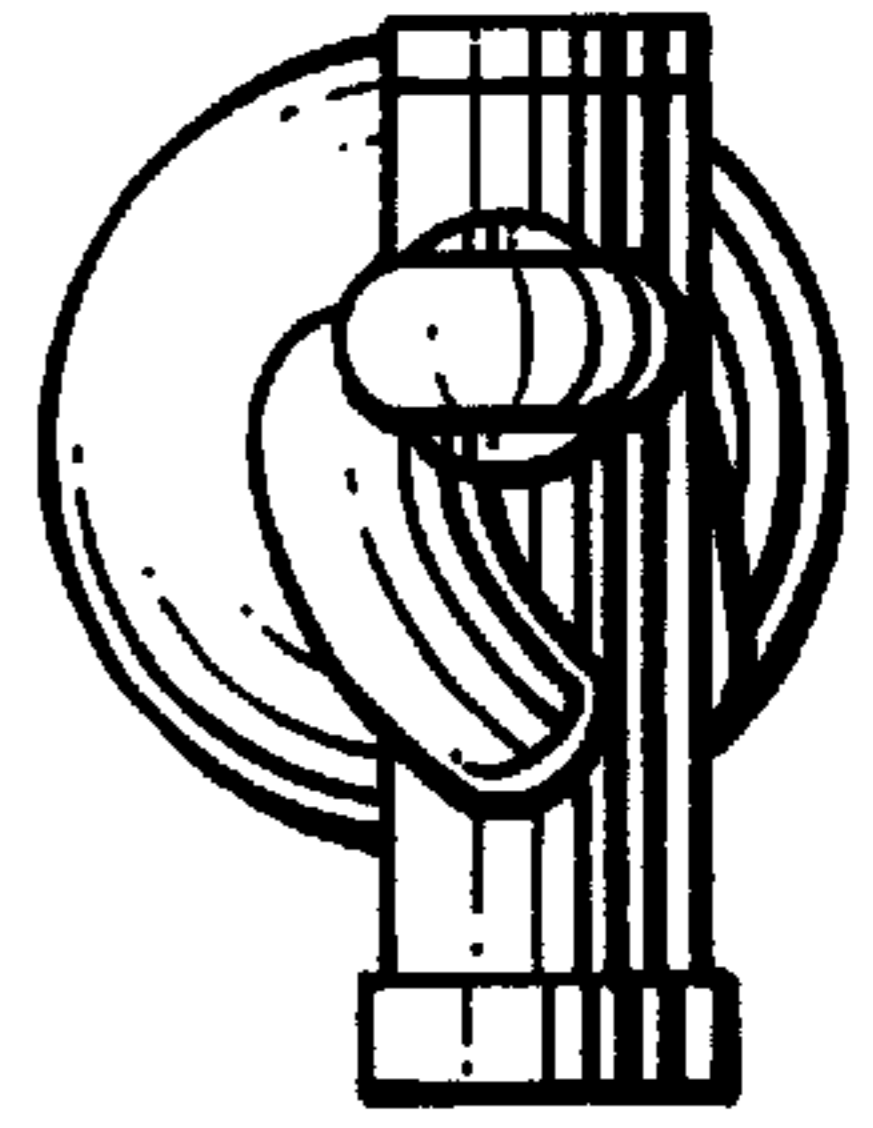

Fig. 31

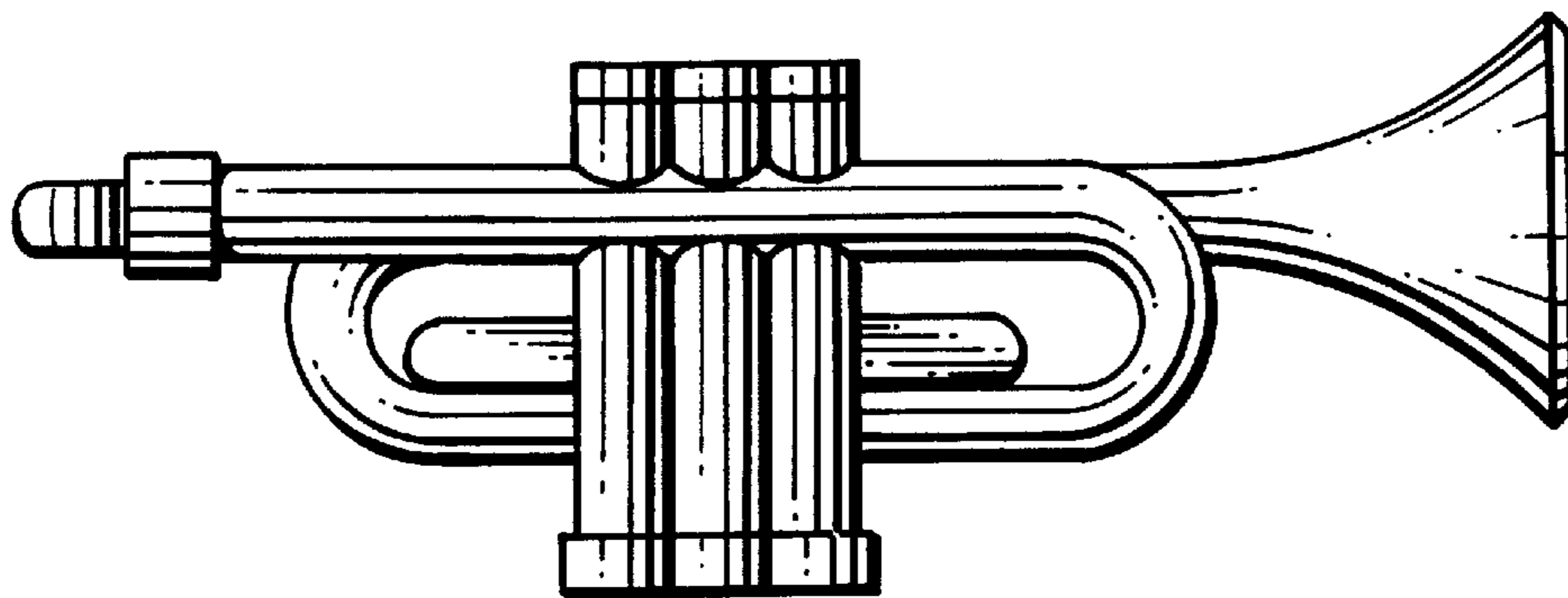

Fig. 32

