



US00D410833S

**United States Patent** [19]  
**Hasegawa**

[11] **Patent Number: Des. 410,833**  
[45] **Date of Patent: \*\* Jun. 8, 1999**

[54] **MULTI-TOOL**

[76] Inventor: **Katsumi Hasegawa**, 3-9-5  
Iwamoto-cho, Chiyoda-ku, Tokyo 101,  
Japan

[\*\*] Term: **14 Years**

[21] Appl. No.: **29/073,093**

[22] Filed: **Jun. 30, 1997**

[51] **LOC (6) Cl.** ..... **08-05**

[52] **U.S. Cl.** ..... **D8/105; D8/55**

[58] **Field of Search** ..... D8/51, 52, 55,  
D8/105, 106; 7/118, 125, 126, 127, 128,  
129, 131, 132, 160, 163, 165; 30/153, 162

[56] **References Cited**

**U.S. PATENT DOCUMENTS**

- D. 137,408 3/1944 Frisk .
- D. 338,386 8/1993 Frazer ..... D8/105

(List continued on next page.)

**OTHER PUBLICATIONS**

Hong Kong Enterprise, p. 179, see multi-purpose tool HWF01 (top center) Nov. 1988.

Handsome Rewards, see "pocket workshop" tool shown Jul. 17, 1989.

Yorkcraft Master tool Flyer, see pictured tool May 1993.

Hoffritz Holiday Catalog, p. 24, see item #17280, page center 1988.

*Primary Examiner*—Martie K. Holtje

*Attorney, Agent, or Firm*—Kolisch Hartwell Dickinson McCormack & Heuser

[57] **CLAIM**

The ornamental design for a multi-tool, as shown and described.

**DESCRIPTION**

FIG. 1 is an elevation of the front of a multi-tool showing my new design;

FIG. 2 is an elevation of the back of the multi-tool shown in FIG. 1;

FIG. 3 is a plan view of the top of the multi-tool shown in FIG. 1;

FIG. 4 is a plan view of the bottom of the multi-tool shown in FIG. 1;

FIG. 5 is an elevation of the left side of the multi-tool shown in FIG. 1;

FIG. 6 is an elevation of the right side of the multi-tool shown in FIG. 1;

FIG. 7 is a perspective view of the multi-tool shown in FIG. 1, showing the right side, front and bottom of the multi-tool;

FIG. 8 is a perspective view of the multi-tool shown in FIG. 1, showing the right side, back and top of the multi-tool;

FIG. 9 is a perspective view of the multi-tool similar to the multi-tool shown in FIG. 1, manipulated to an open position, and therefore showing the multi-tool in an alternative configuration showing the front and bottom of the multi-tool;

FIG. 10 is a perspective view of the multi-tool shown in FIG. 9, showing the back and top of the multi-tool;

FIG. 11 is an elevation of the front of a multi-tool similar to the multi-tool shown in FIG. 1, shown with elements of the multi-tool manipulated to open positions, and therefore showing the multi-tool in as another alternate configuration;

FIG. 12 is an elevation of the back of the multi-tool shown in FIG. 11;

FIG. 13 is a plan view of the top of the multi-tool shown in FIG. 11;

FIG. 14 is a plan view of the bottom of the multi-tool shown in FIG. 11;

FIG. 15 is an elevation of the left side of the multi-tool shown in FIG. 11;

FIG. 16 is an elevation of the right side of the multi-tool shown in FIG. 11;

FIG. 17 is a perspective view of the multi-tool shown in FIG. 11, showing the left side, front and top of the multi-tool; and,

FIG. 18 is a perspective view of the multi-tool shown in FIG. 11, showing the right side, back and bottom of the multi-tool.

**1 Claim, 6 Drawing Sheets**

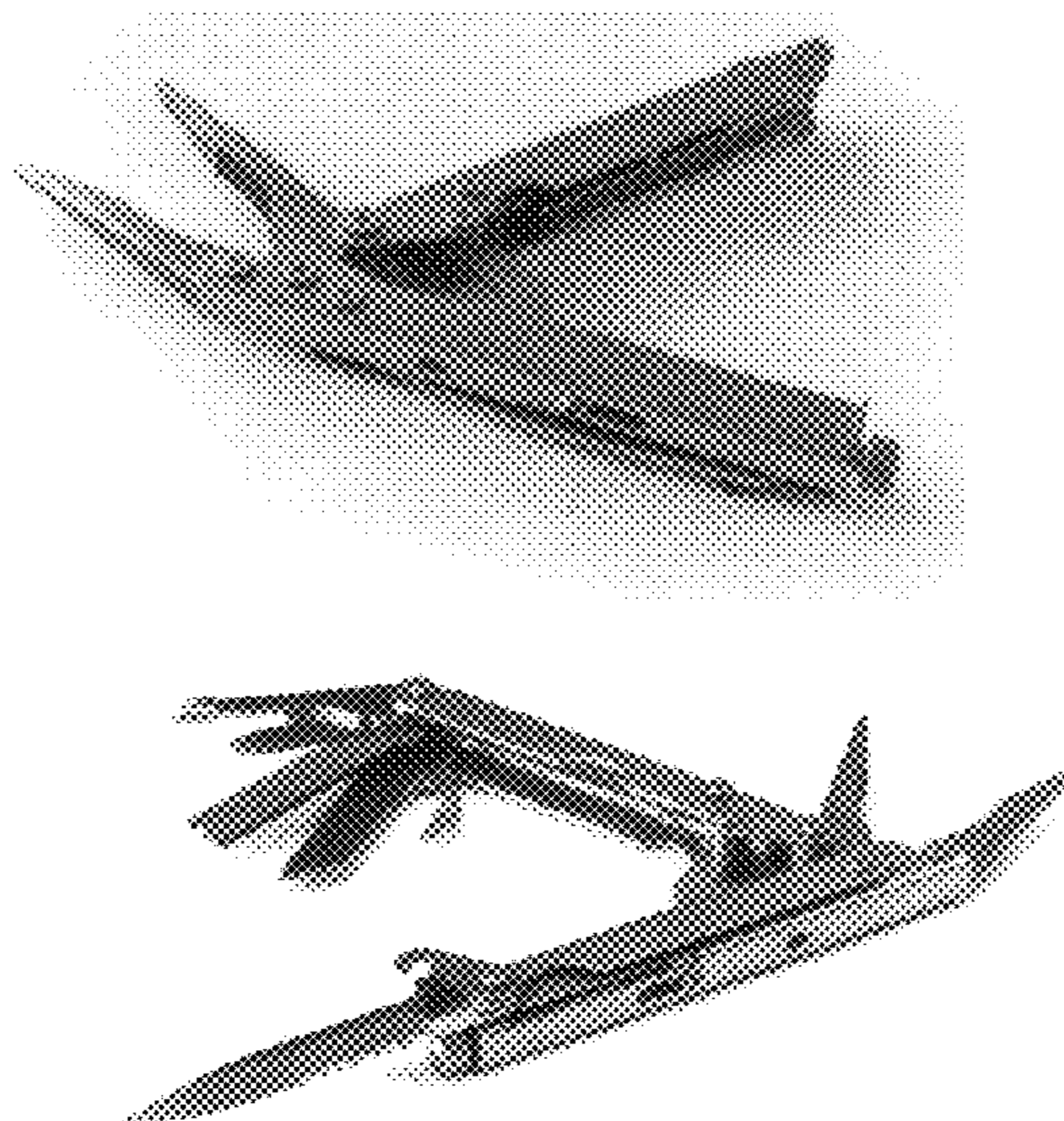

U.S. PATENT DOCUMENTS					
			1,561,993	11/1925	Nielsen .
			1,619,181	3/1927	Beretz .
			2,514,130	7/1950	Jones .
			2,561,682	7/1951	Barnett .
			2,575,652	11/1951	Bovee .
			2,641,149	6/1953	Petersen .
			2,747,446	5/1956	Eder .
			3,044,081	7/1962	Robinson .
			3,798,687	3/1974	Stevens .
			3,947,905	4/1976	Neff .
			4,238,862	12/1980	Leatherman ..... 7/128
			4,502,220	3/1985	Aoki .
			4,563,833	1/1986	Aucoin .
			4,744,272	5/1988	Leatherman .
			4,888,869	12/1989	Leatherman .
			4,942,637	7/1990	Yeang-Yai .
			5,029,355	7/1991	Thai ..... 7/118
			5,062,173	11/1991	Collins .
			5,074,046	12/1991	Kolesky .
			5,142,721	9/1992	Sessions et al. .
			5,157,996	10/1992	Keyvani .
			5,212,844	5/1993	Sessions et al. .
			5,267,366	12/1993	Frazer .
			5,497,522	3/1996	Chen .
D. 368,634	4/1996	Frazer ..... D8/105			
D. 371,498	7/1996	Lai ..... D8/55 X			
D. 382,182	8/1997	Seber et al. .... D8/55			
D. 384,872	10/1997	Yeh ..... D8/105			
542,601	7/1895	Baker .			
589,392	8/1897	Kolar .			
596,096	12/1897	Watts .			
614,537	11/1898	Dahlquist .			
649,334	5/1900	Meloos .			
662,005	11/1900	Lewis .			
790,432	5/1905	Heilrath .			
857,459	6/1907	Hendrickson .			
888,795	5/1908	Fields .			
896,746	8/1908	McCarty .			
1,174,132	3/1916	Dragun .			
1,184,746	5/1916	Hanson .			
1,187,842	6/1916	Kaas .			
1,370,906	3/1921	Newton .			
1,467,661	9/1923	Undy .			
1,474,592	11/1923	Jacoby .			
1,511,340	10/1924	Jackson .			
1,524,694	2/1925	Di Maio .			
1,551,328	8/1925	Perry .			
1,561,833	11/1925	Cruickshank .			

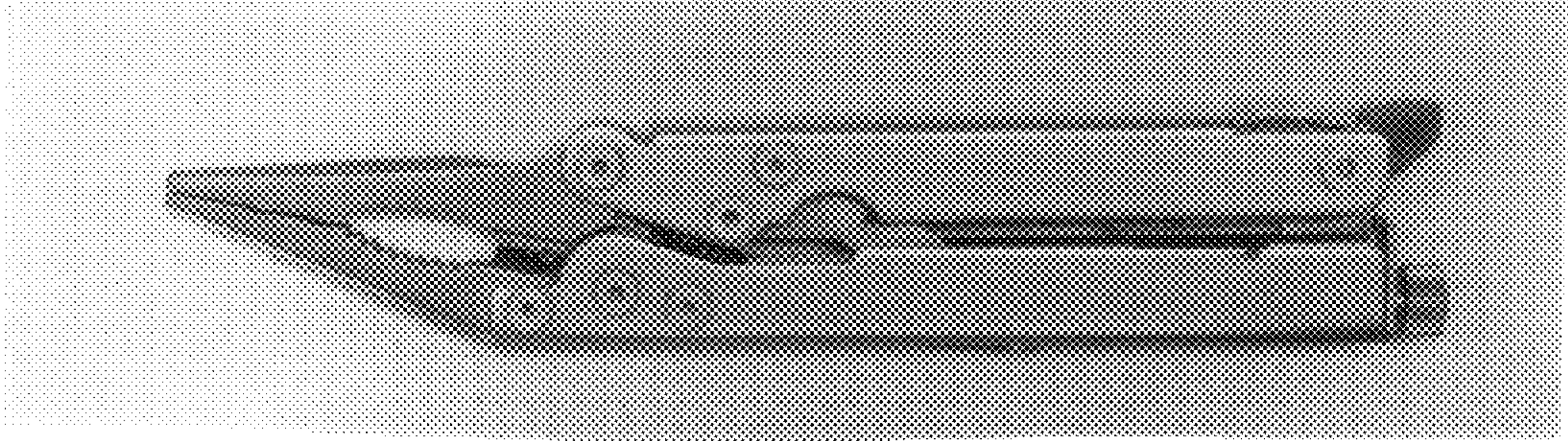

Fig. 1

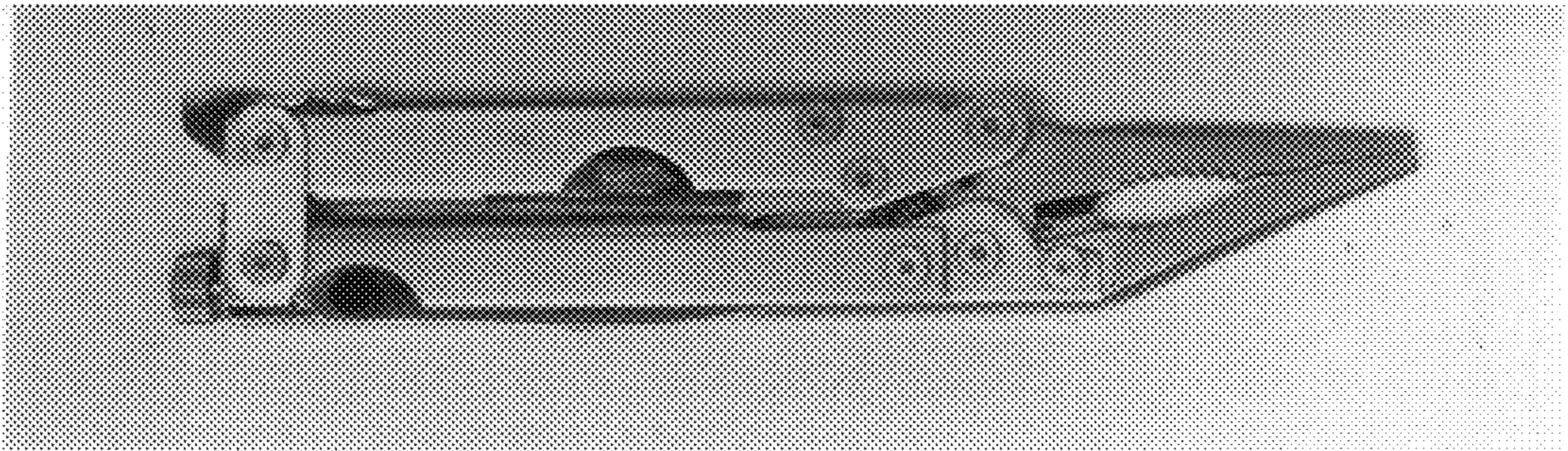

Fig. 2

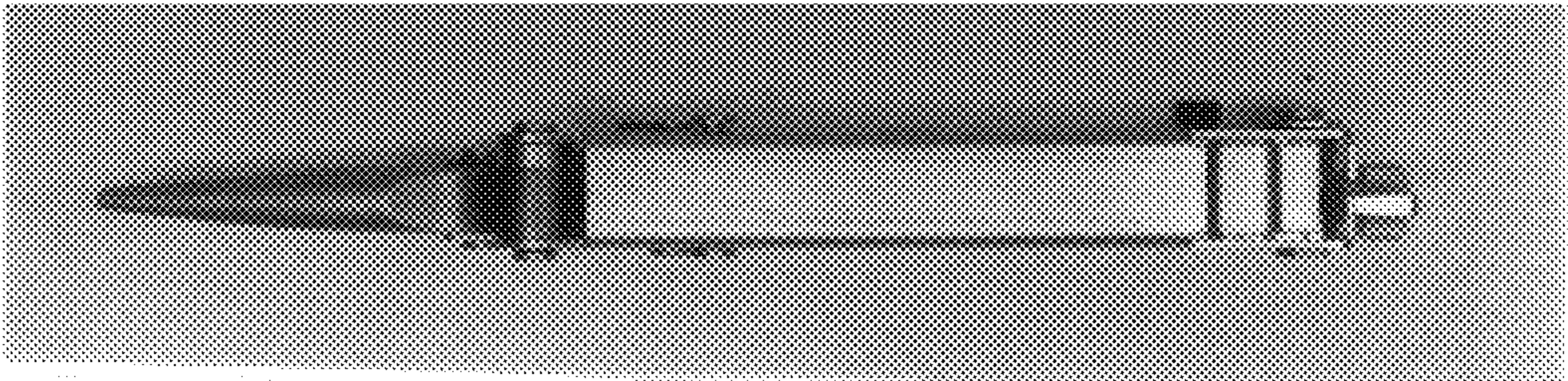

Fig. 3

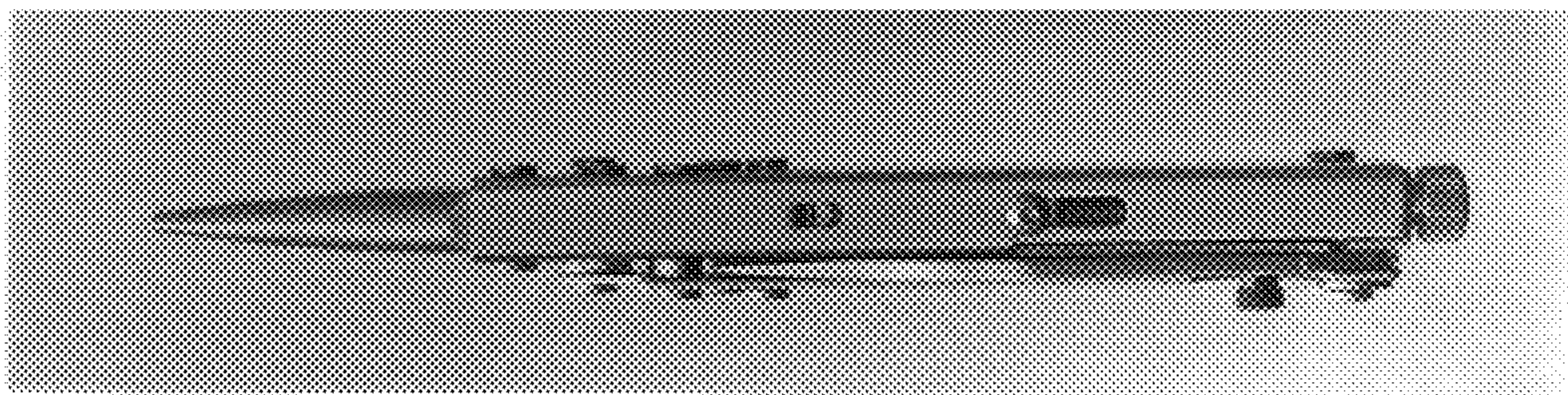

Fig. 4

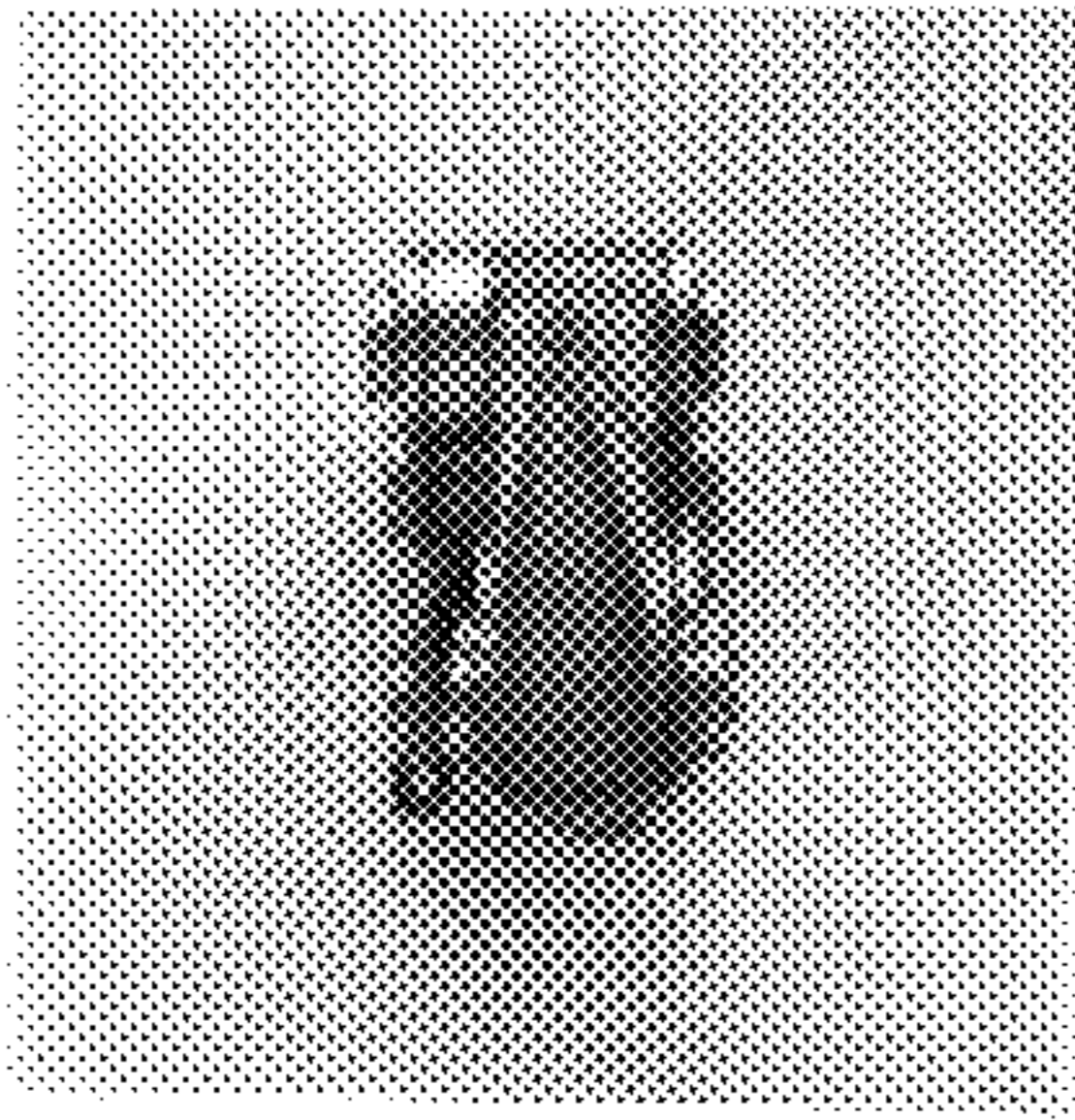

Fig. 5

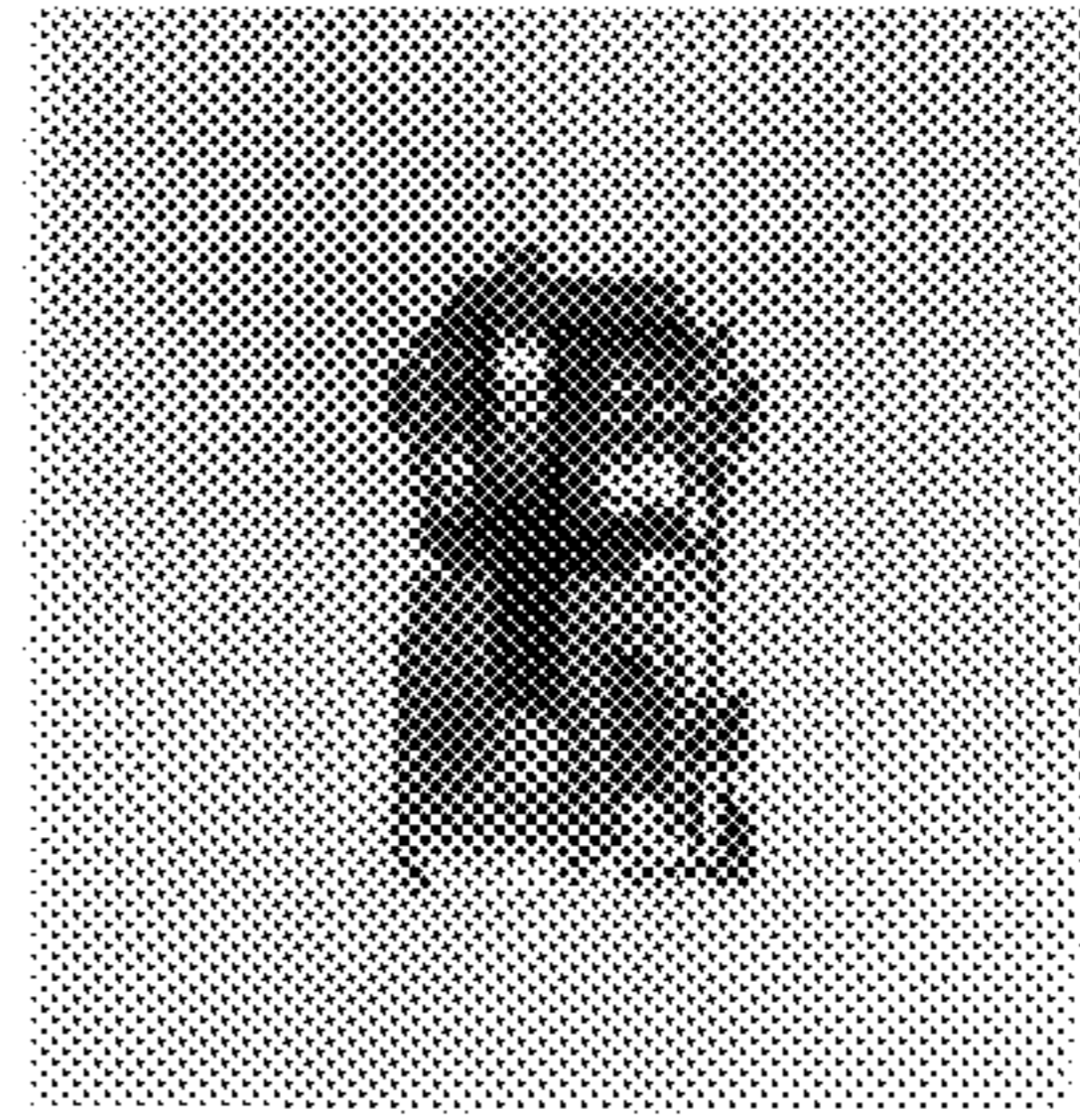

Fig. 6

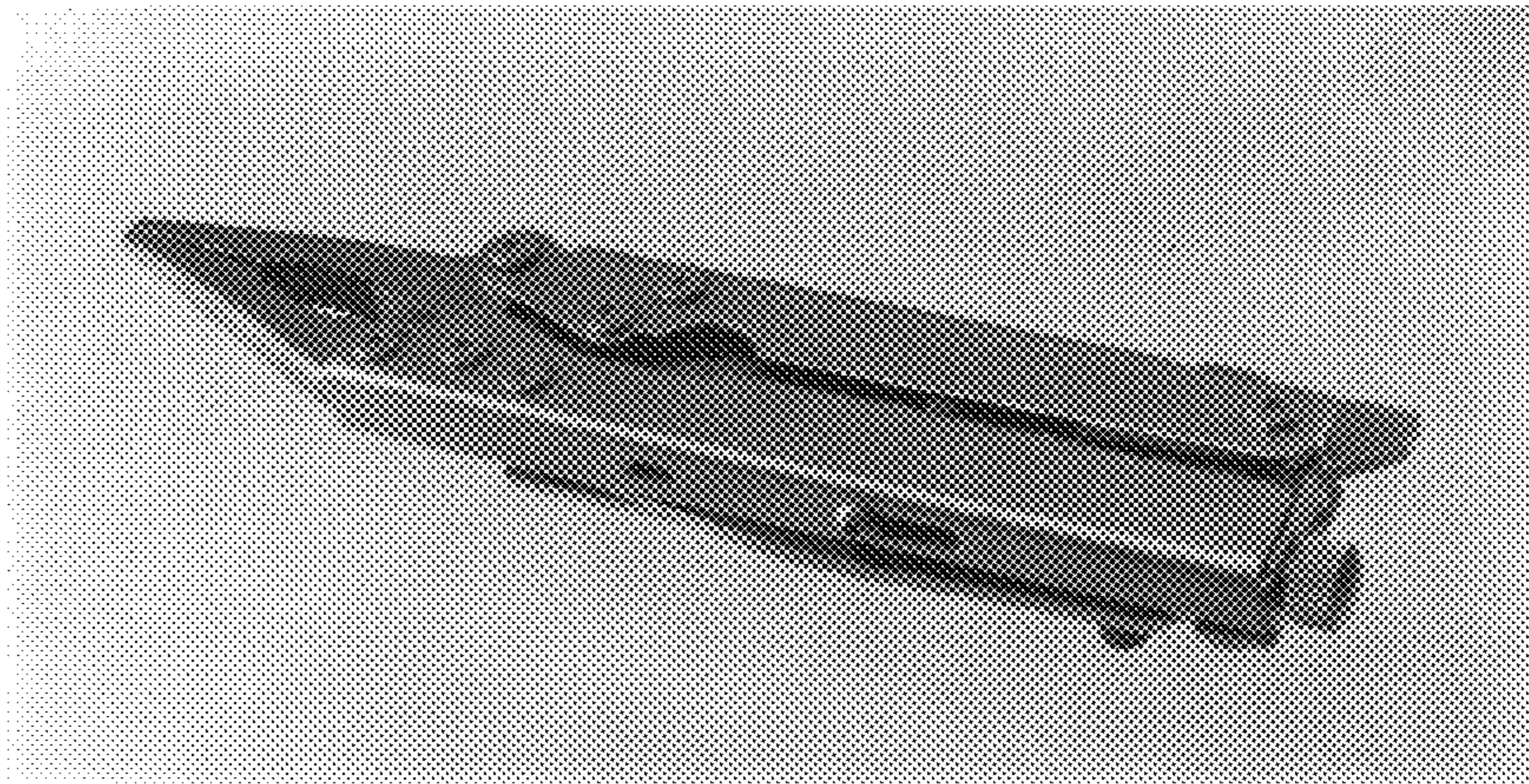

Fig. 7

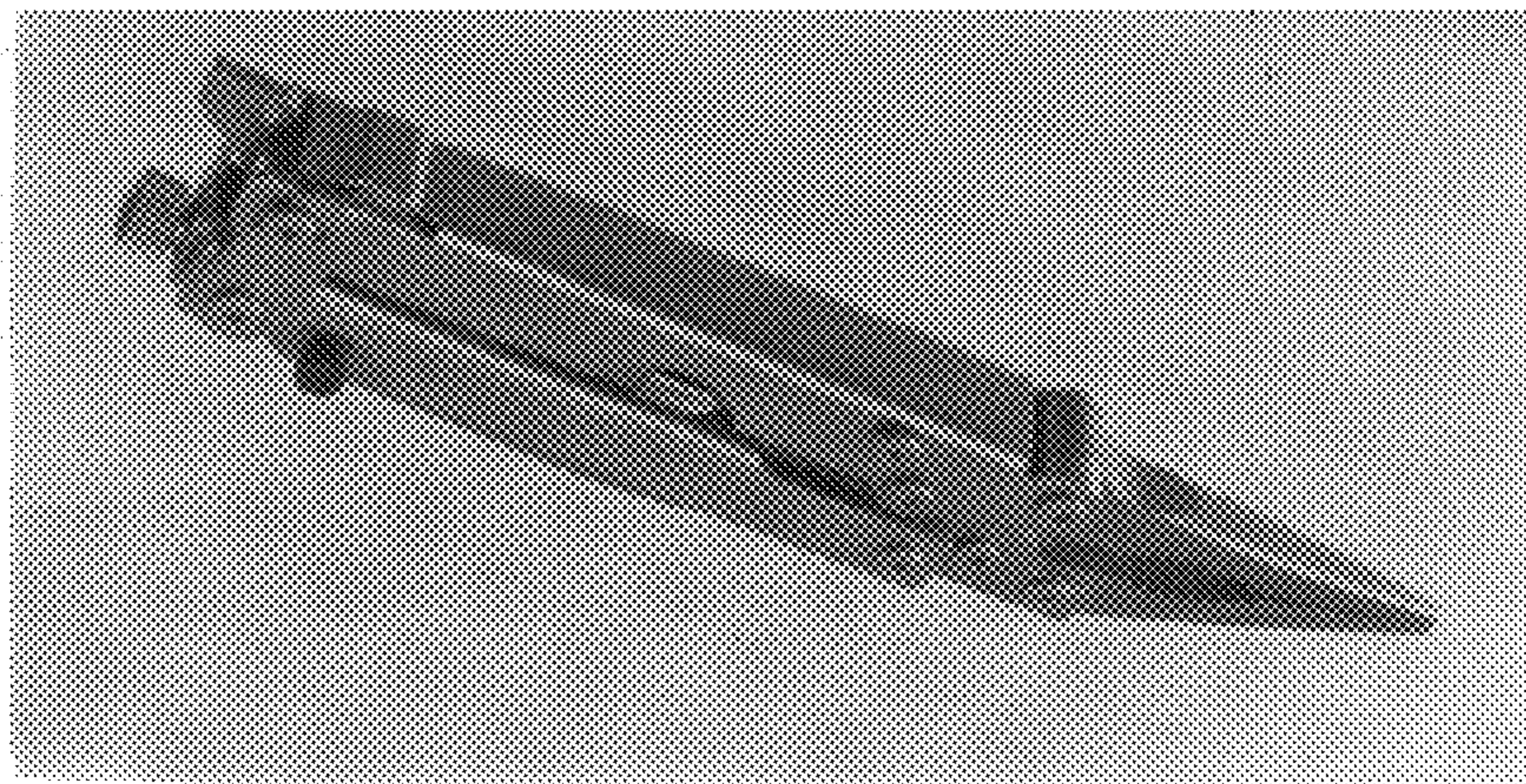

Fig. 8

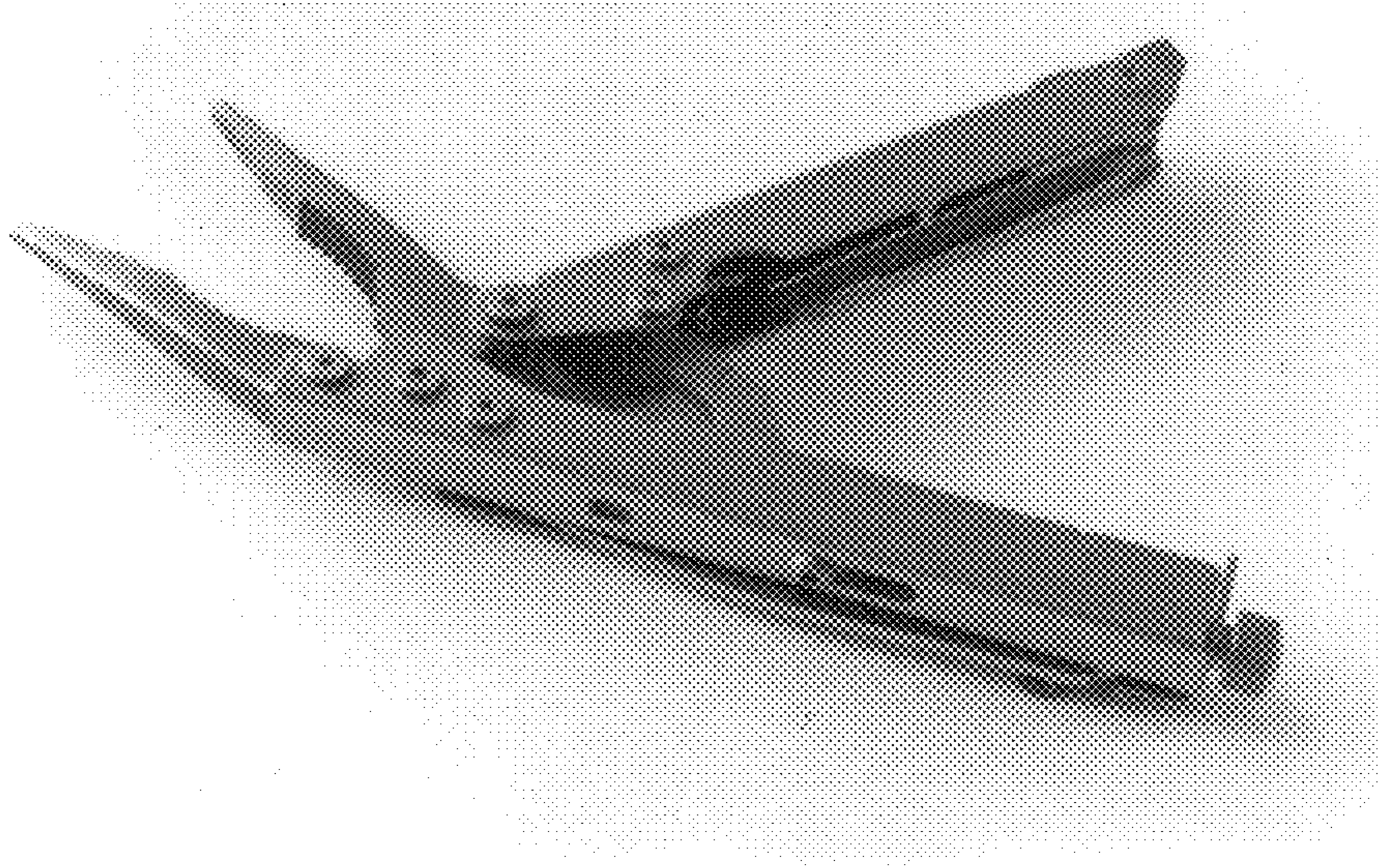

Fig. 9

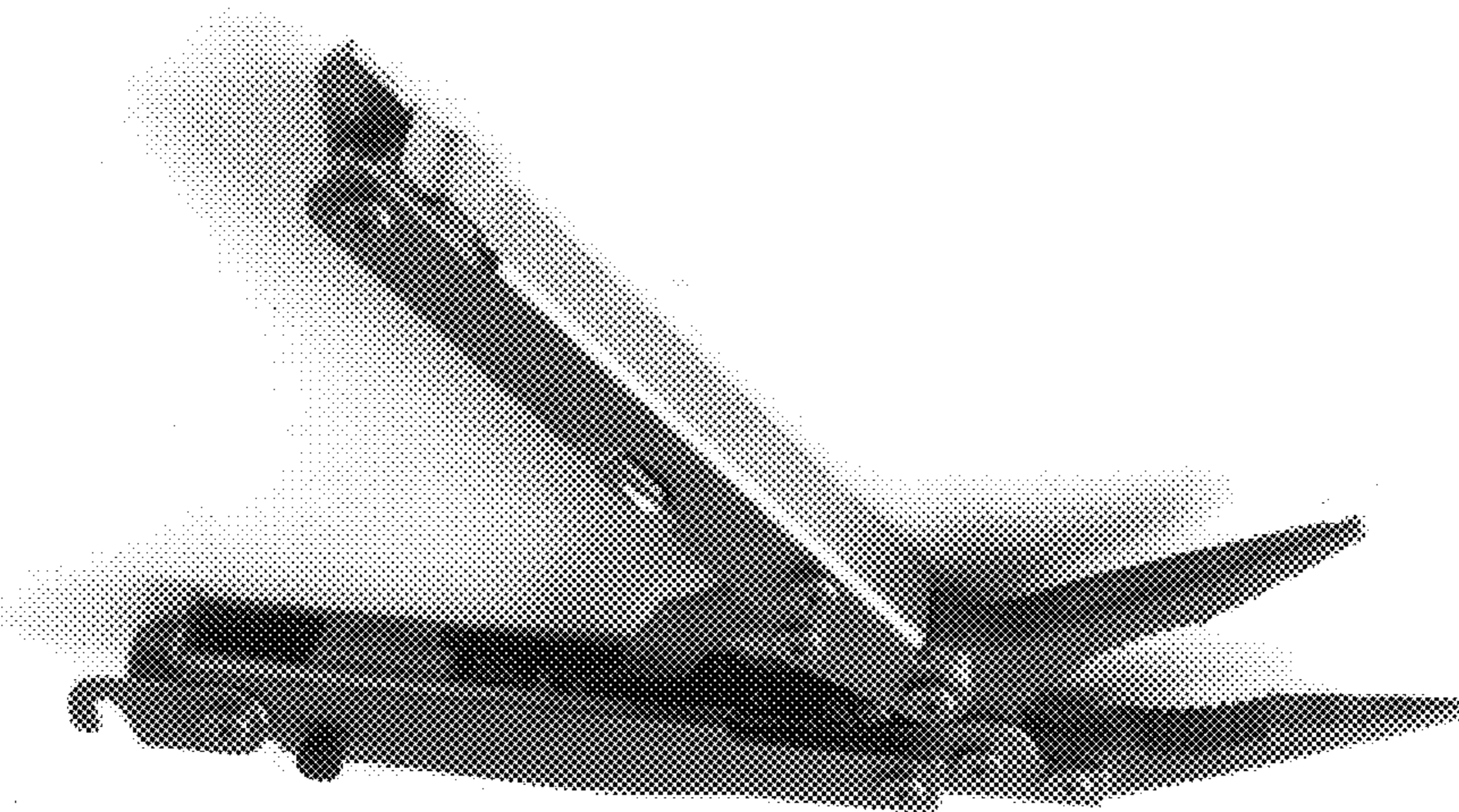

Fig. 10

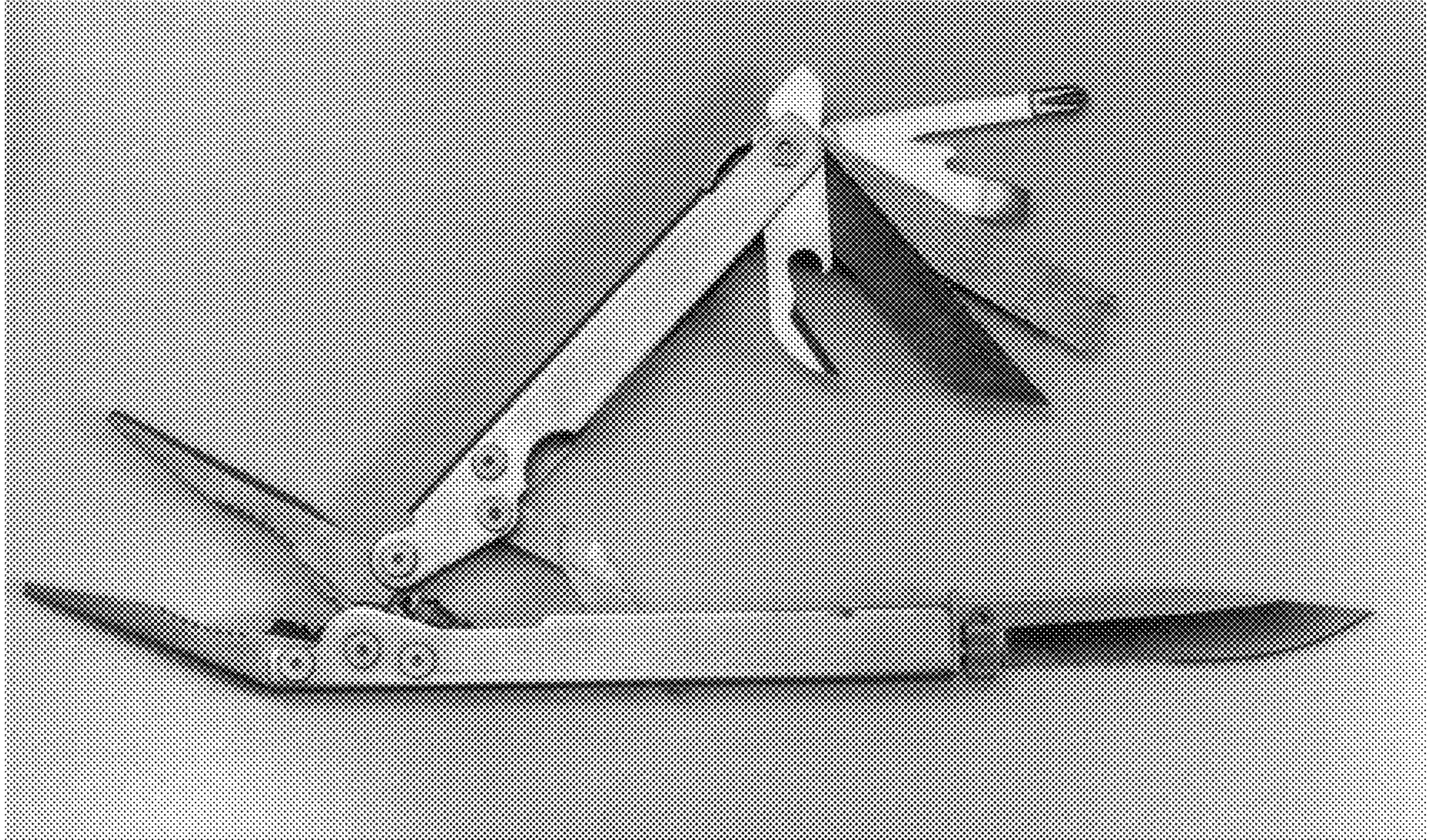

Fig. 11

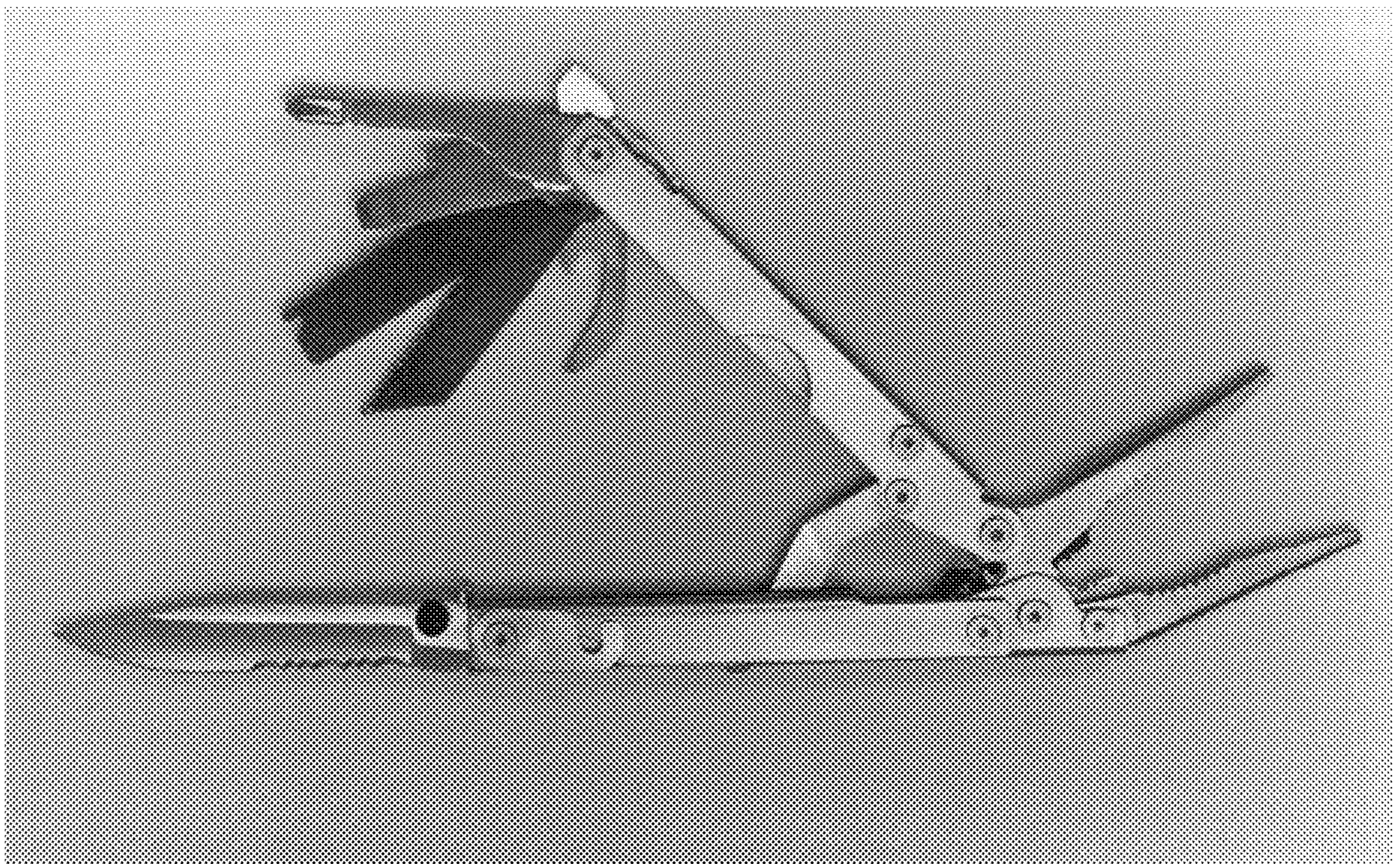

Fig. 12

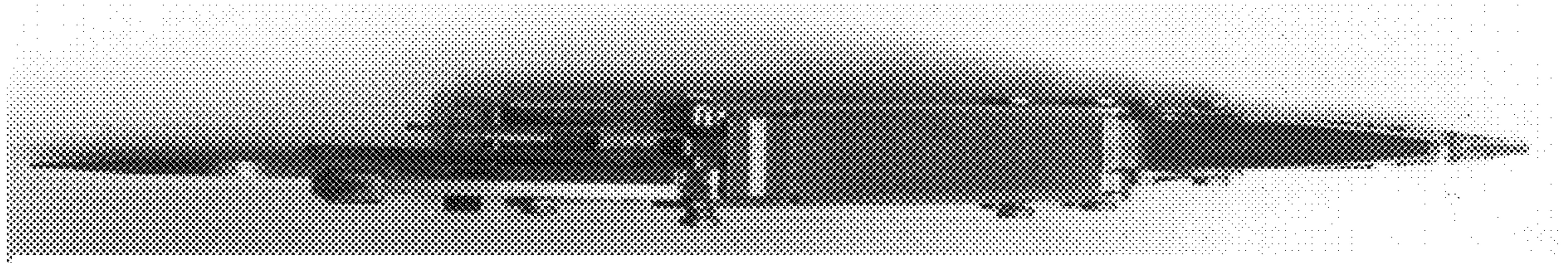

Fig. 13

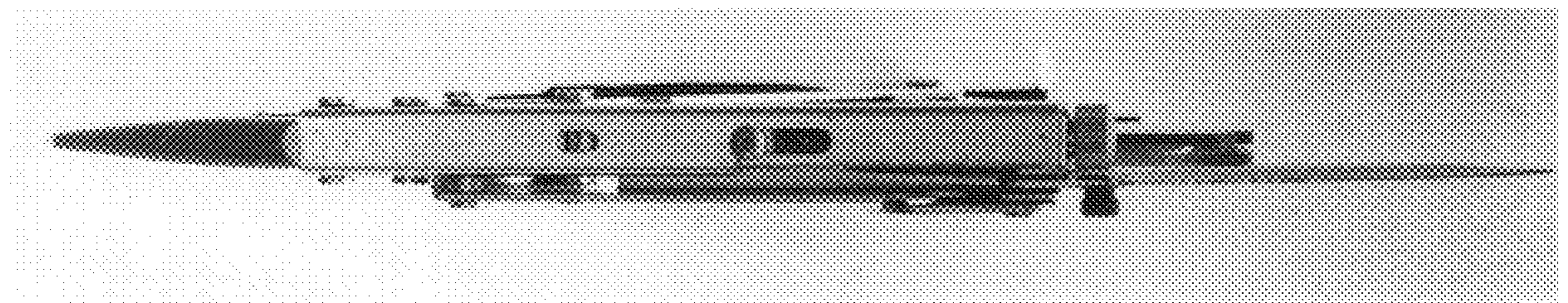

Fig. 14

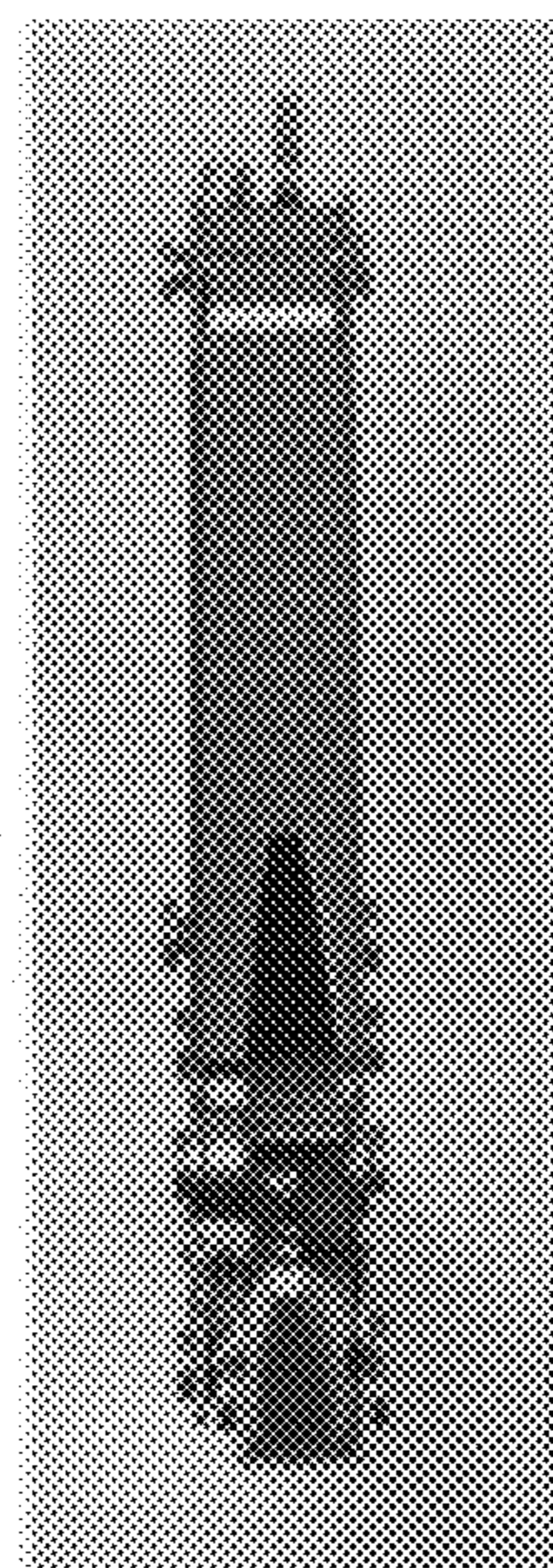

Fig. 15

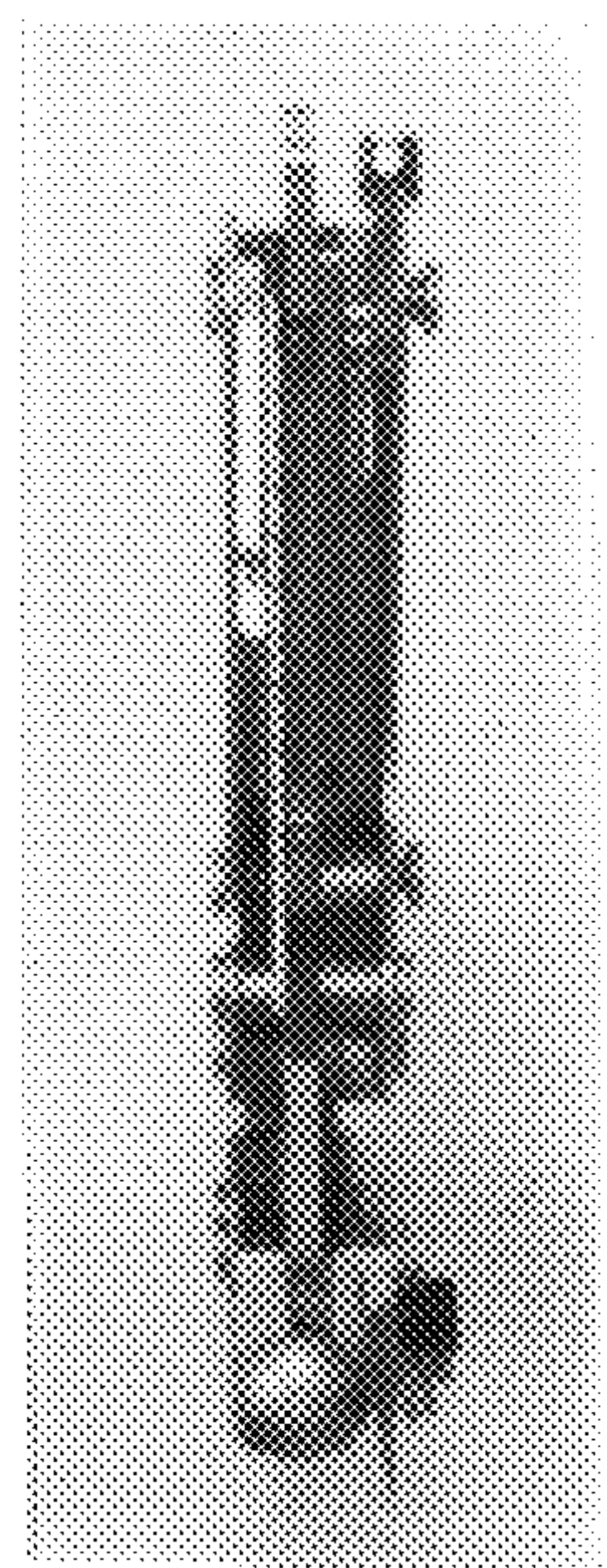

Fig. 16

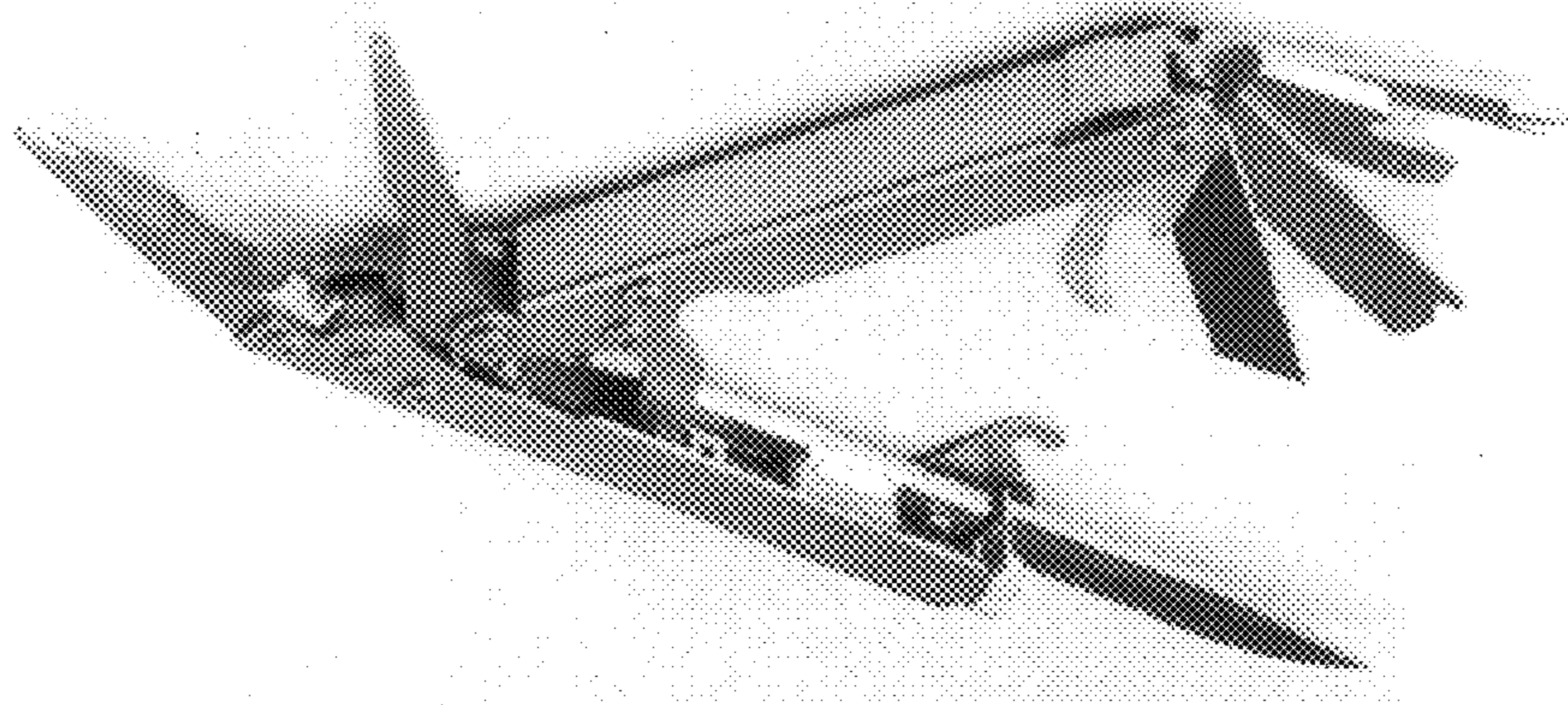

Fig. 17

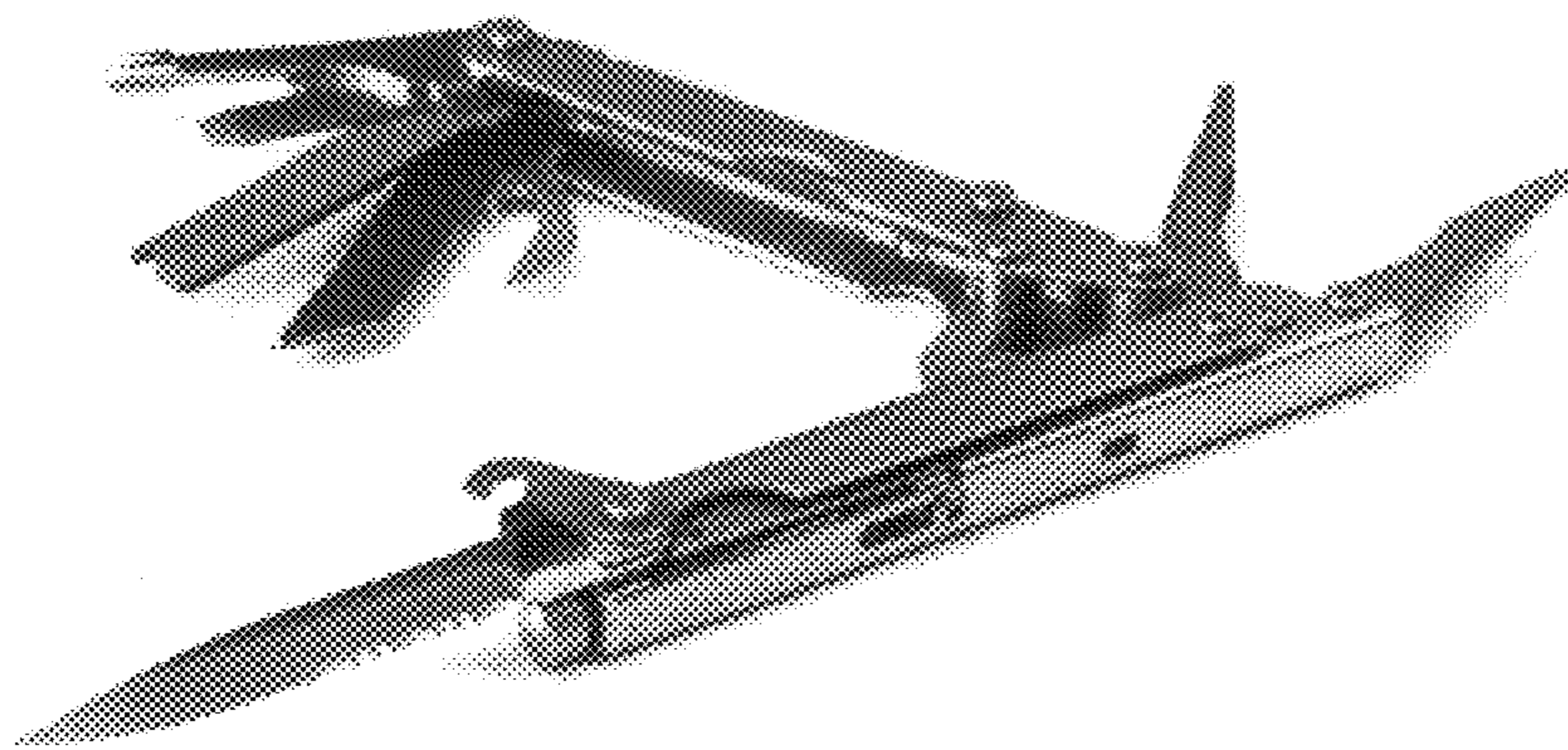

Fig. 18