



US00D410831S

United States Patent [19]

Dossett

[11] Patent Number: Des. 410,831

[45] Date of Patent: ** Jun. 8, 1999

[54] **TOOL HANDLE**

[75] Inventor: **Richard A. Dossett**, Louisville, Ky.

[73] Assignee: **Vermont American Corporation**,
Louisville, Ky.

[**] Term: **14 Years**

[21] Appl. No.: **29/089,507**

[22] Filed: **Jun. 16, 1998**

[51] **LOC (6) Cl.** **08-03**

[52] **U.S. Cl.** **D8/97; D8/107**

[58] **Field of Search** D8/95, 97, 107,
D8/98, 7; 30/166.3, 509, 513, 515, 517,
506; D7/395

[56] **References Cited**

U.S. PATENT DOCUMENTS

D. 288,400	2/1987	Vosbikian	D8/107
D. 299,413	1/1989	DeCarolis	D8/97
D. 307,383	4/1990	Huang	D8/97
D. 323,966	2/1992	Tanabe	D8/97
D. 333,825	3/1993	Price	D15/142
D. 341,761	11/1993	Weimann	D8/97
D. 359,672	6/1995	Gardiner	D8/97
D. 365,257	12/1995	Huang	D8/10
D. 368,633	4/1996	Nakayama	D8/95
D. 375,243	11/1996	Hasegawa	D8/107
D. 387,263	12/1997	Bidstrup et al.	D8/97

Primary Examiner—Philip S. Hyder
Attorney, Agent, or Firm—McDermott, Will & Emery

[57] **CLAIM**

The ornamental design for a tool handle, as shown and described.

DESCRIPTION

FIG. 1 is a front perspective view of a tool handle showing my new design;
 FIG. 2 is a top plan view of the tool handle of FIG. 1;
 FIG. 3 is a bottom plan view of the tool handle of FIG. 1;
 FIG. 4 is a right side elevation view of the tool handle of FIG. 1;
 FIG. 5 is a left side elevation view of the tool handle of FIG. 1;
 FIG. 6 is a front elevation view of the tool handle of FIG. 1;
 FIG. 7 is a rear elevation view of the tool handle of FIG. 1;
 FIG. 8 is a front perspective view of a modified embodiment of the tool handle;
 FIG. 9 is a top plan view of the tool handle of FIG. 8;
 FIG. 10 is a bottom plan view of the tool handle of FIG. 8;
 FIG. 11 is a right side elevation view of the tool handle of FIG. 8;
 FIG. 12 is a left side elevation view of the tool handle of FIG. 8;
 FIG. 13 is a front elevation view of the tool handle of FIG. 8; and,
 FIG. 14 is a rear elevation view of the tool handle of FIG. 8.

The broken line portions of the drawing disclosure are for illustrative purposes only and form no part of the claimed design.

1 Claim, 8 Drawing Sheets

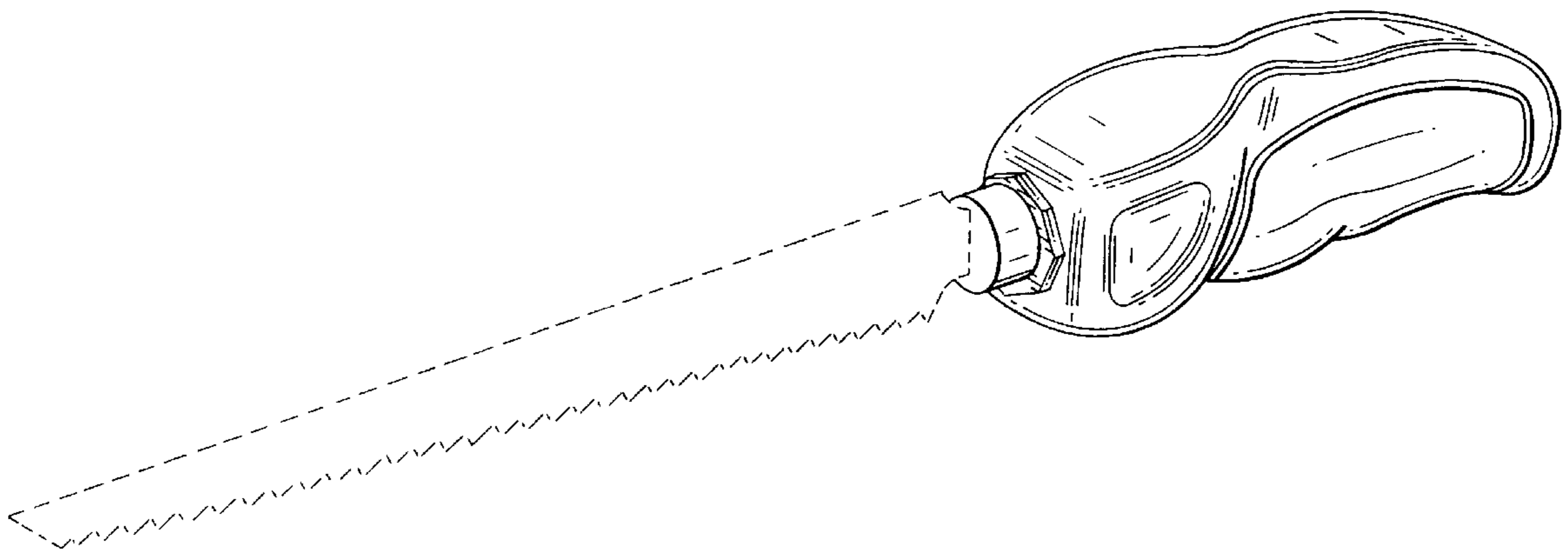

FIG. 1

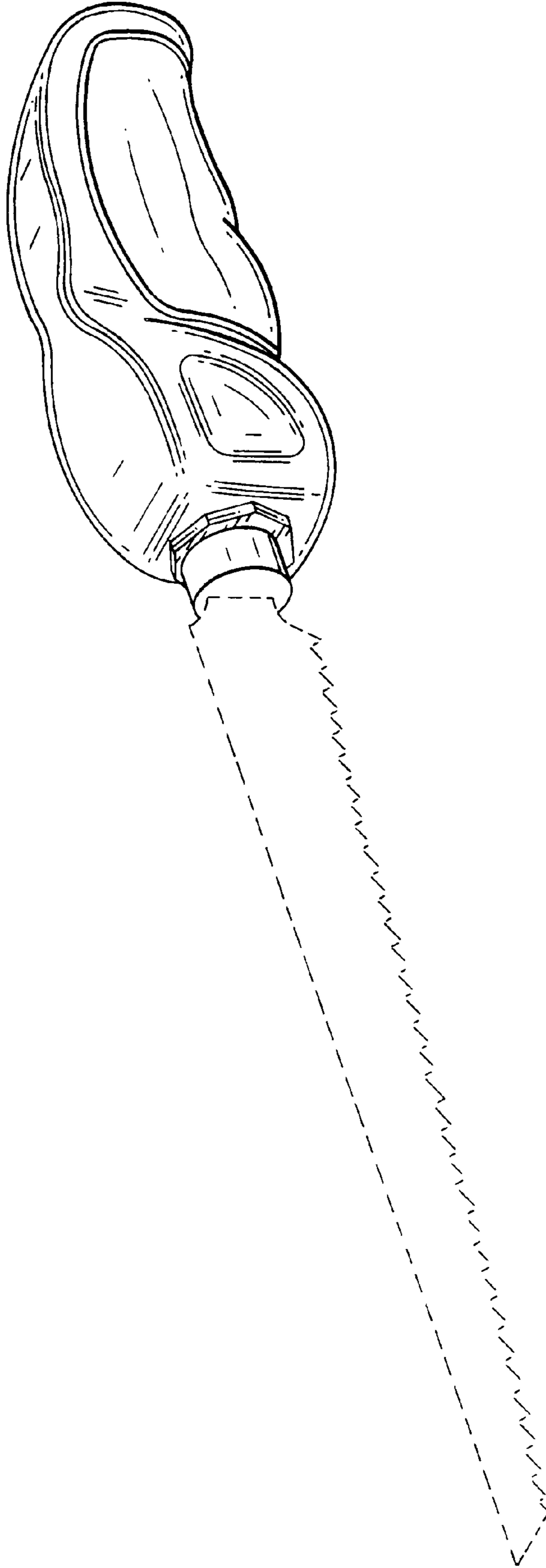

FIG. 2

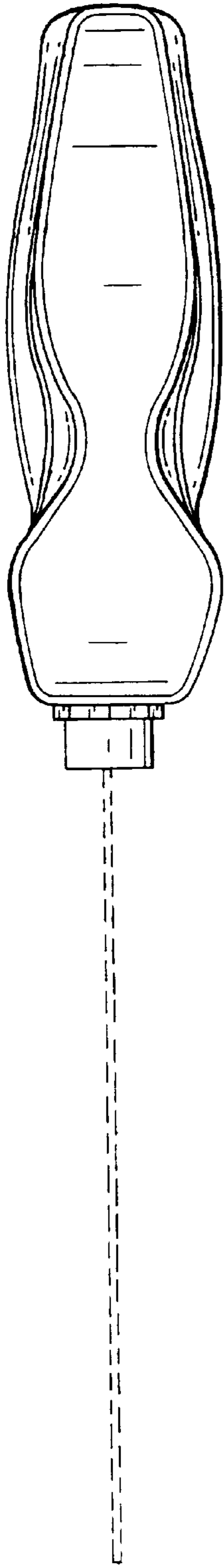

FIG. 3

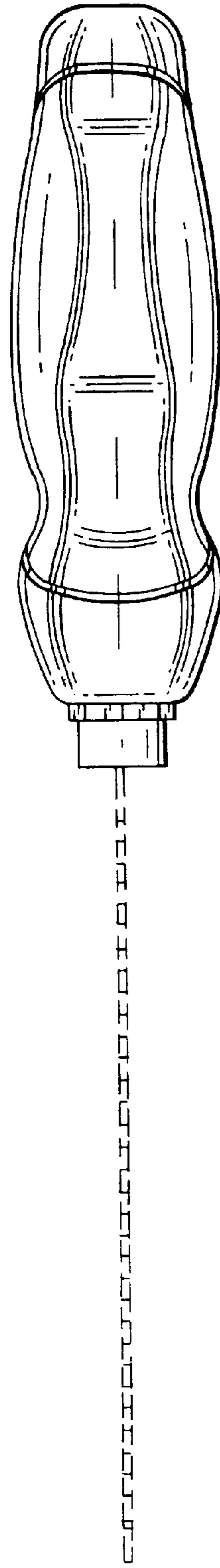

FIG. 4

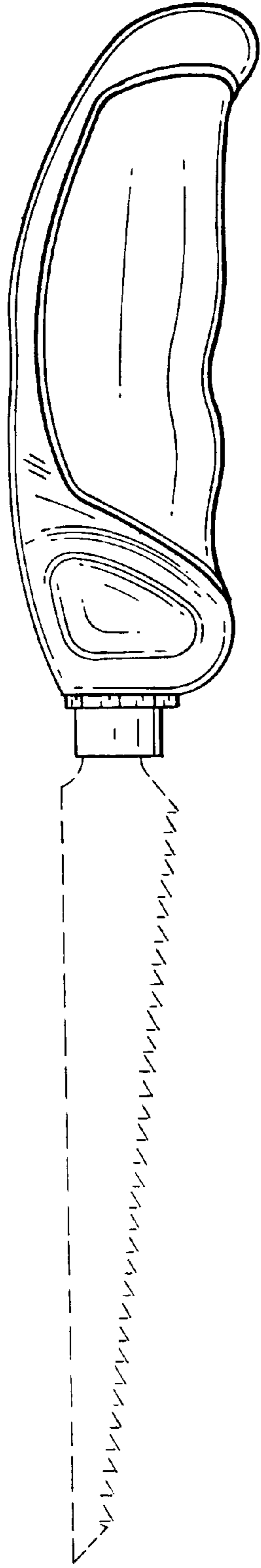

FIG. 5

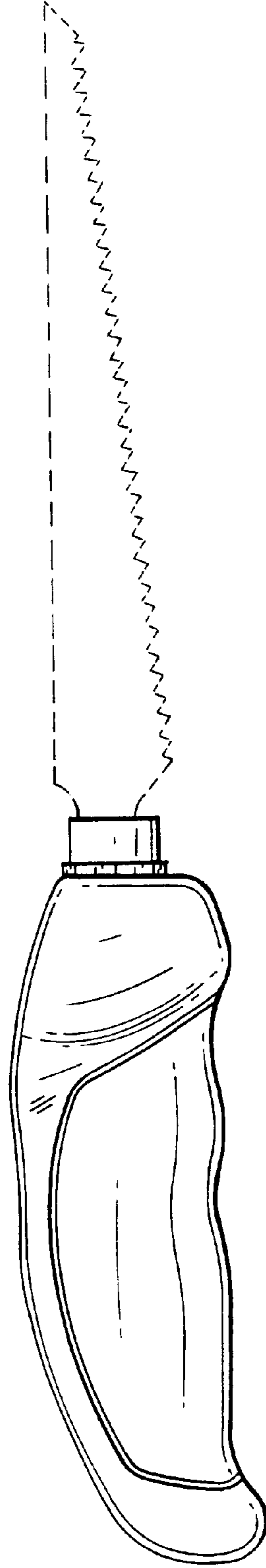

FIG. 6

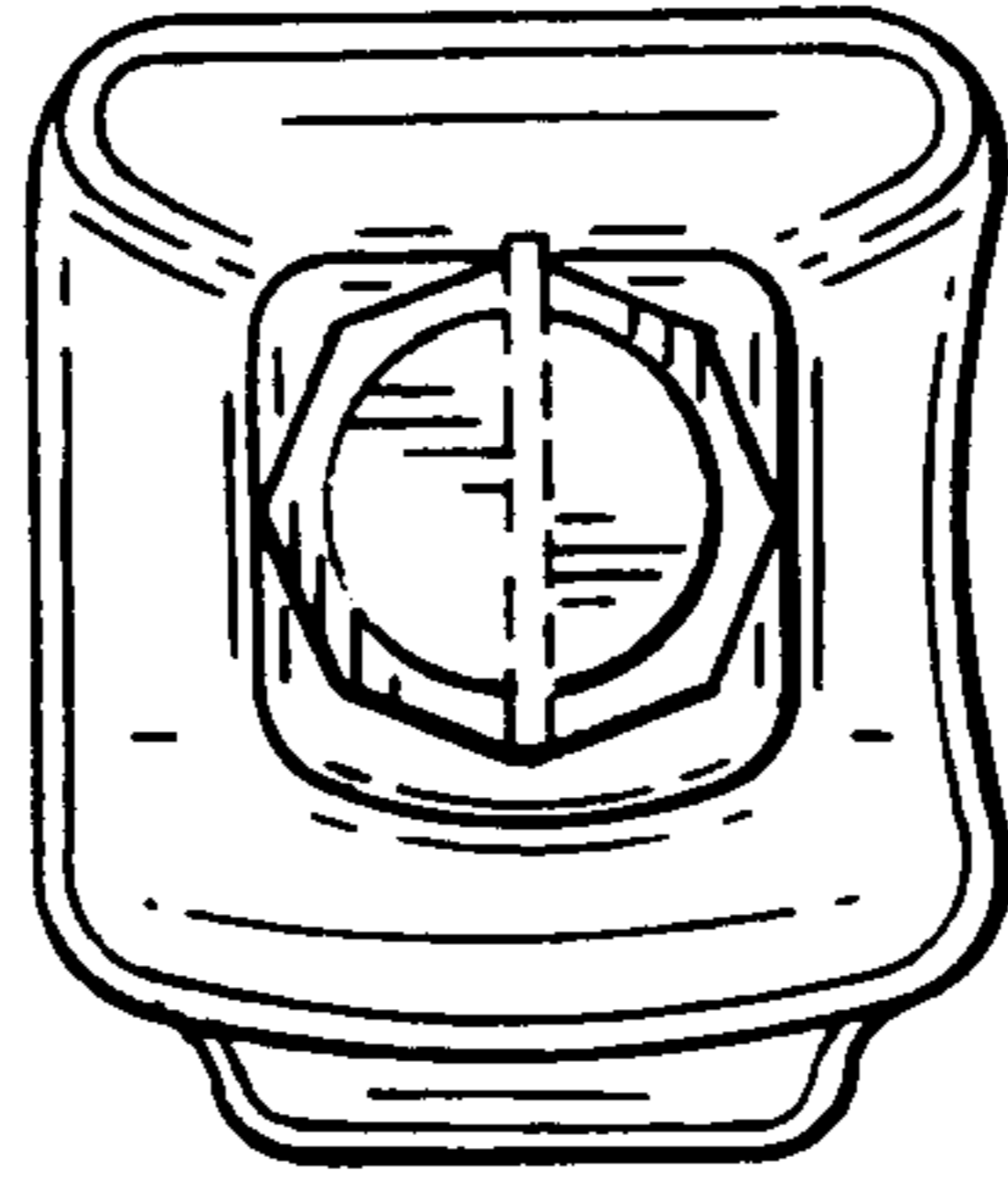

FIG. 7

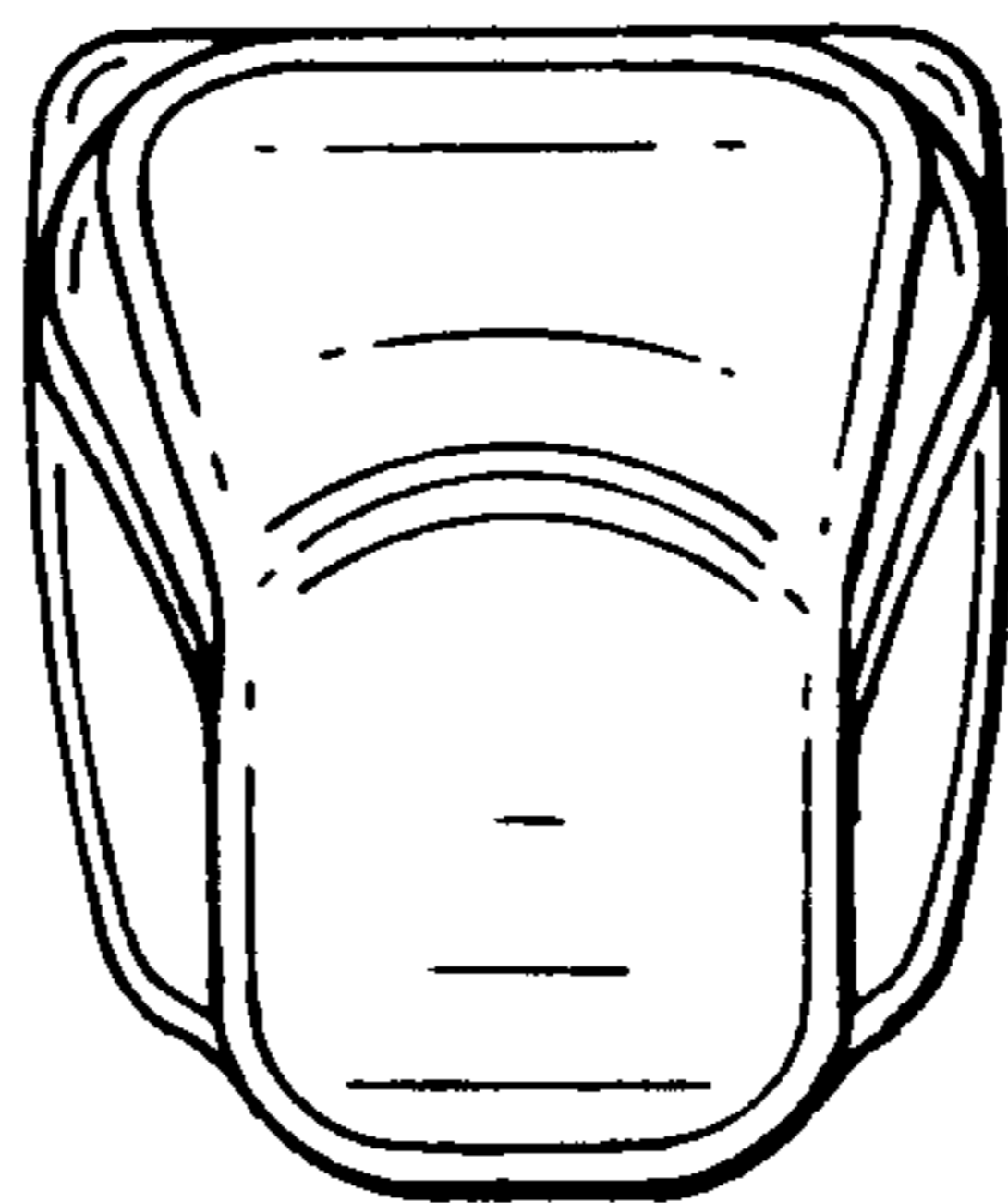

FIG. 8

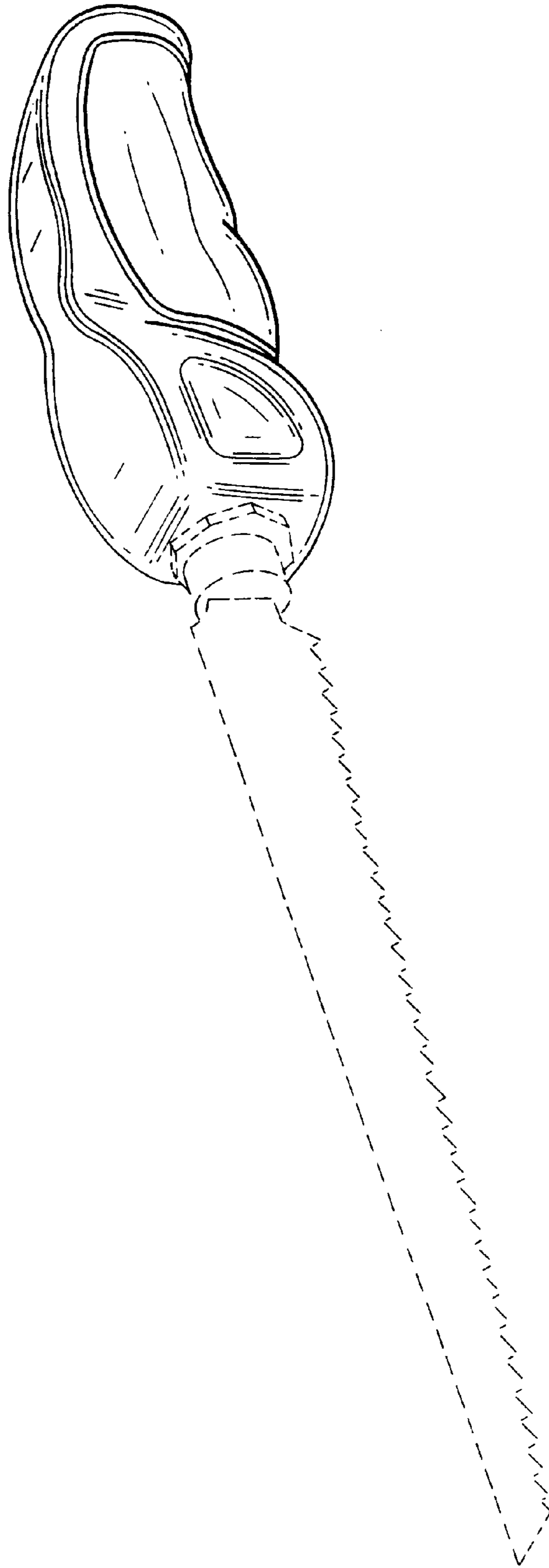

FIG. 9

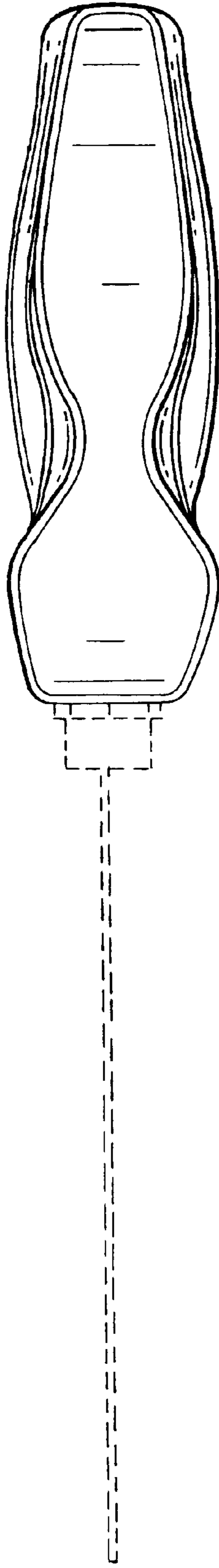

FIG. 10

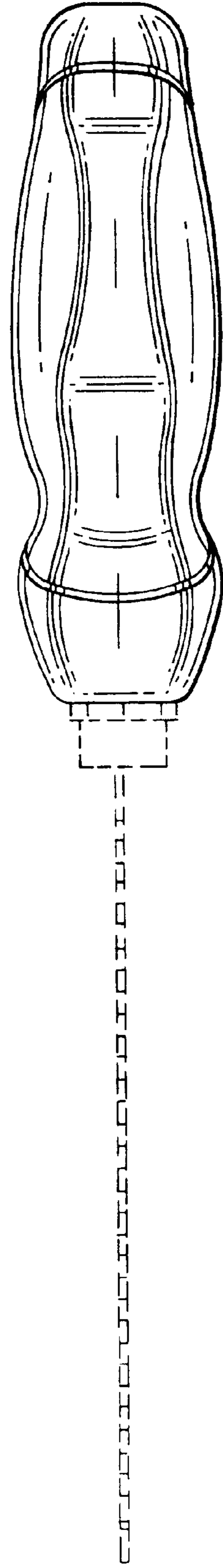

FIG. 11

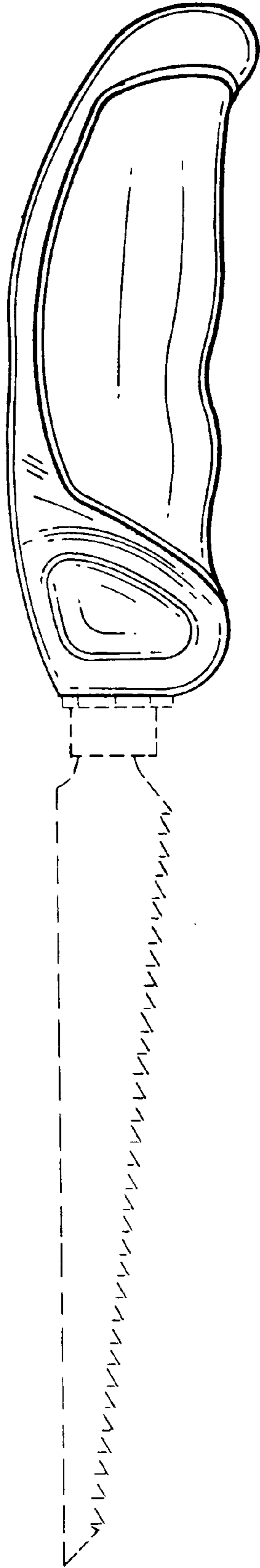

FIG. 12

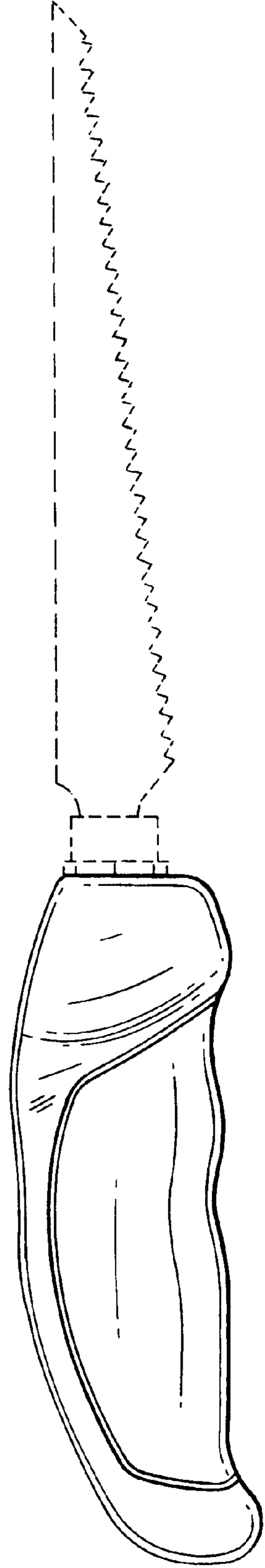

FIG. 13

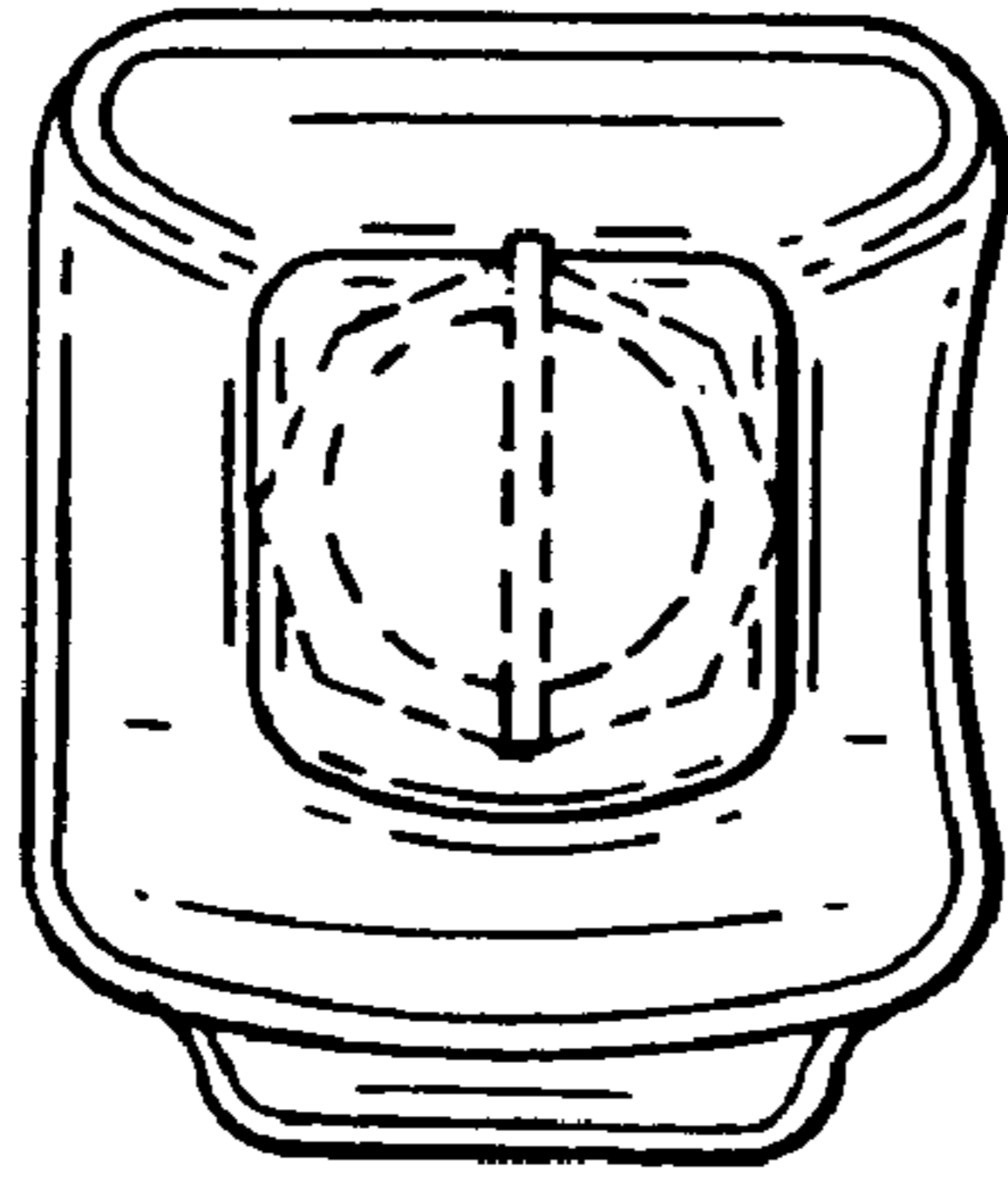

FIG. 14

