



US00D410759S

United States Patent [19]
Petruzzi

[11] **Patent Number: Des. 410,759**
[45] **Date of Patent: ** Jun. 8, 1999**

[54] **TAPERED CARD LIGHT**

[76] Inventor: **Thomas G. Petruzzi**, 5118 Belleville Ave., Orlando, Fla. 32812

[**] Term: **14 Years**

[21] Appl. No.: **29/088,257**

[22] Filed: **May 19, 1998**

[51] **LOC (6) Cl.** **26-02**

[52] **U.S. Cl.** **D26/37**

[58] **Field of Search** D26/37-50; 362/157,
362/158, 183-208

[56] **References Cited**

U.S. PATENT DOCUMENTS

D. 336,688	6/1993	Osterhout	D26/37
D. 367,720	3/1996	Sinclair	D26/37
D. 396,120	7/1998	Petruzzi	D26/37
D. 402,067	12/1998	Sinclair	D26/37

Primary Examiner—Marcus A. Jackson
Attorney, Agent, or Firm—Allen, Dyer, Doppelt, Milbrath & Gilchrist, P.A.

[57] **CLAIM**

The ornamental design for a tapered card light, as shown and described.

DESCRIPTION

FIG. 1 is a top, left perspective view of a tapered card light showing my new design;
FIG. 2 is a left side view thereof;
FIG. 3 is a right side view thereof;
FIG. 4 is a front elevation view thereof;
FIG. 5 is a rear elevation view thereof;
FIG. 6 is a top plan view thereof, the bottom view being a mirror image;
FIG. 7 is a top, left perspective view of a second embodiment of FIG. 1;
FIG. 8 is a left side view thereof, the right side view and rear elevation view are as illustrated in FIGS. 3 and 5, respectively;

FIG. 9 is a top plan view thereof, the bottom plan view being a mirror image;
FIG. 10 is a top, left perspective view of a third embodiment of FIG. 1, a mirror image of the embodiment of FIG. 7;
FIG. 11 is a right side view thereof, the left side view and rear elevation view as illustrated in FIGS. 3 and 5, respectively;
FIG. 12 is a top, left perspective view of a fourth embodiment of FIG. 1;
FIG. 13 is a right side view thereof;
FIG. 14 is a left side view thereof;
FIG. 15 is a front elevation view thereof;
FIG. 16 is a rear elevation view thereof;
FIG. 17 is a top plan view thereof, the bottom view being a mirror image;
FIG. 18 is a top, left perspective view of a fifth embodiment of FIG. 1;
FIG. 19 is a left side view thereof;
FIG. 20 is a right side view thereof;
FIG. 21 is a front elevation view thereof;
FIG. 22 is a rear elevation view thereof;
FIG. 23 is a top plan view thereof, the bottom view being a mirror image;
FIG. 24 is a top, left perspective view of a sixth embodiment of FIG. 1;
FIG. 25 is a left side view thereof;
FIG. 26 is a right side view thereof;
FIG. 27 is a front elevation view thereof;
FIG. 28 is a rear elevation view thereof;
FIG. 29 is a top plan view thereof, the bottom view being a mirror image;
FIG. 30 is a top, left perspective view of a seventh embodiment of FIG. 1;
FIG. 31 is a left side view thereof;
FIG. 32 is a right side view thereof;
FIG. 33 is a front elevation view thereof;
FIG. 34 is a rear elevation view thereof; and,
FIG. 35 is a top plan view thereof, the bottom view being a mirror image.

1 Claim, 3 Drawing Sheets

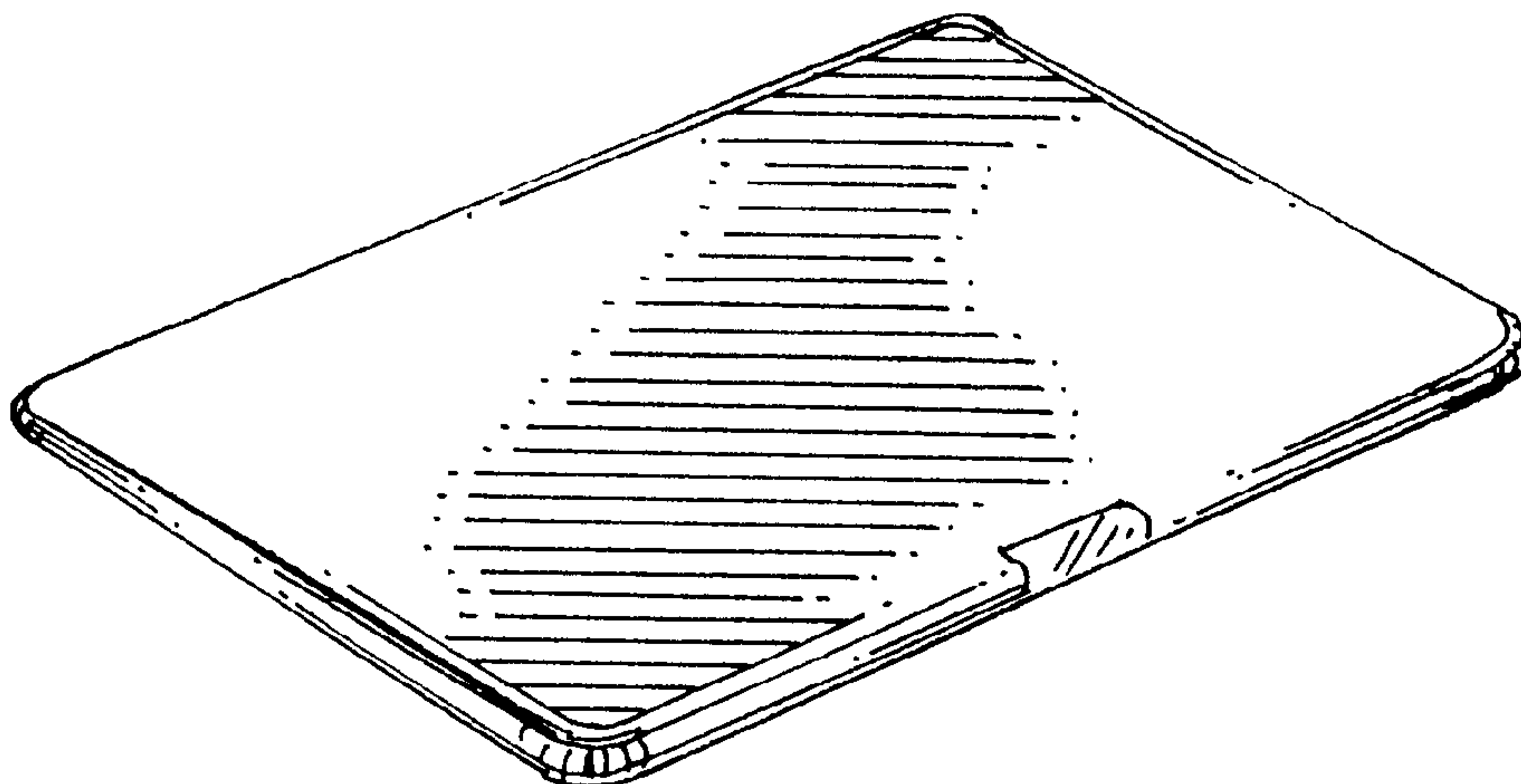

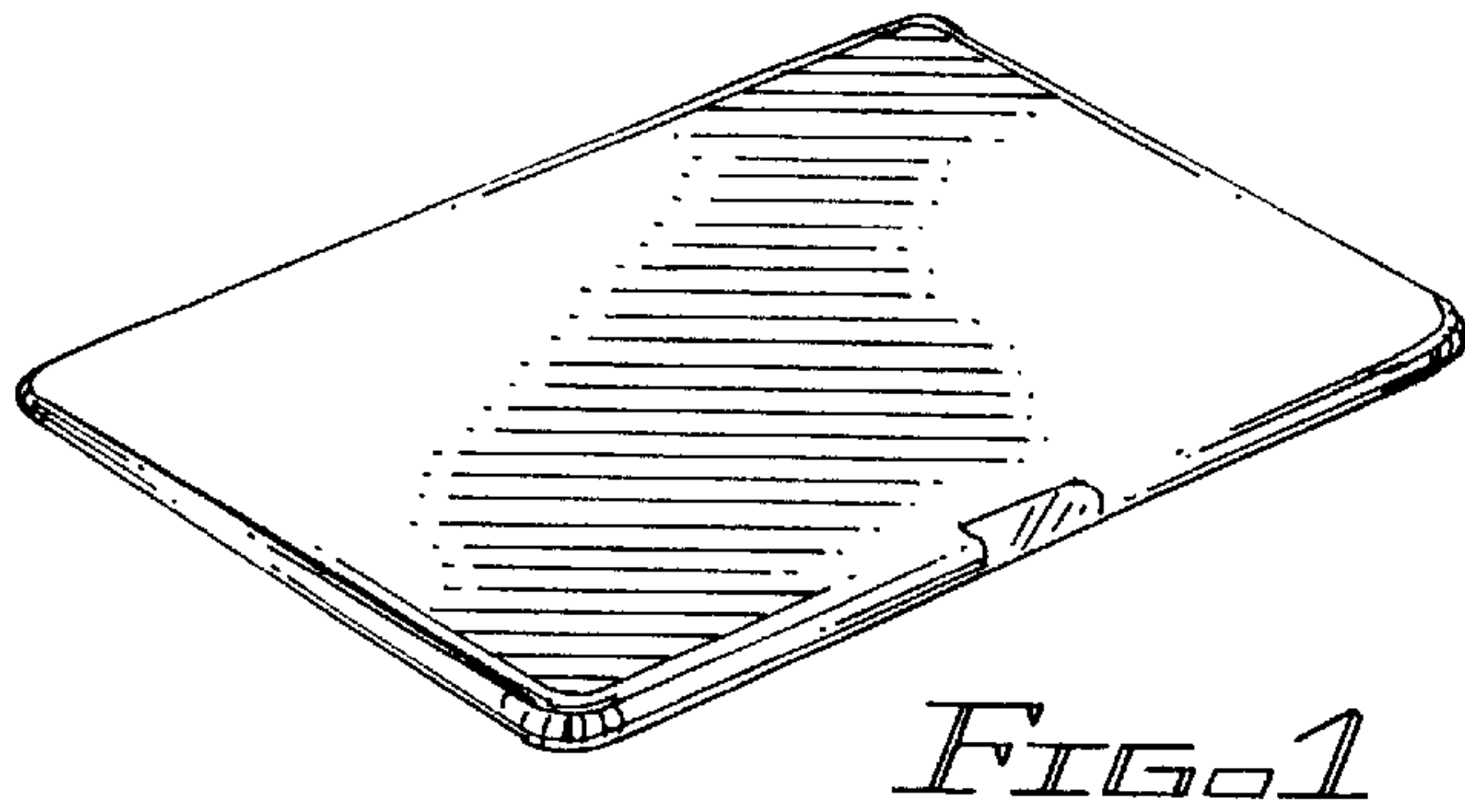

FIG. 1

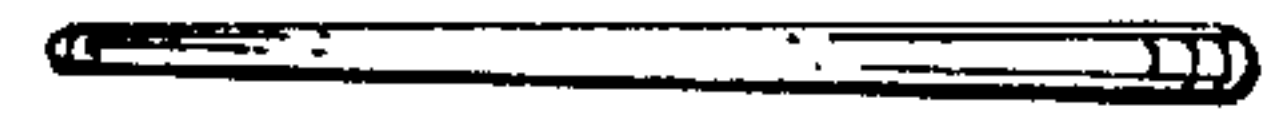

FIG. 2

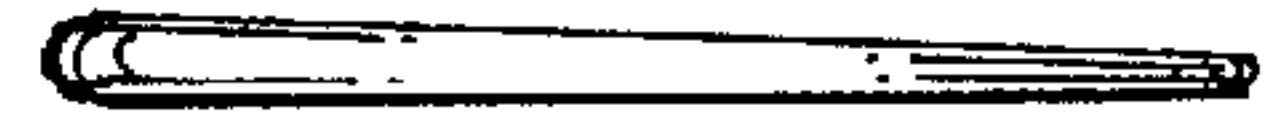

FIG. 3



FIG. 4

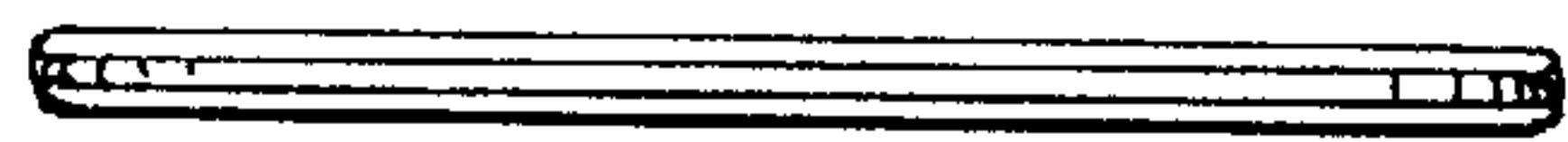

FIG. 5

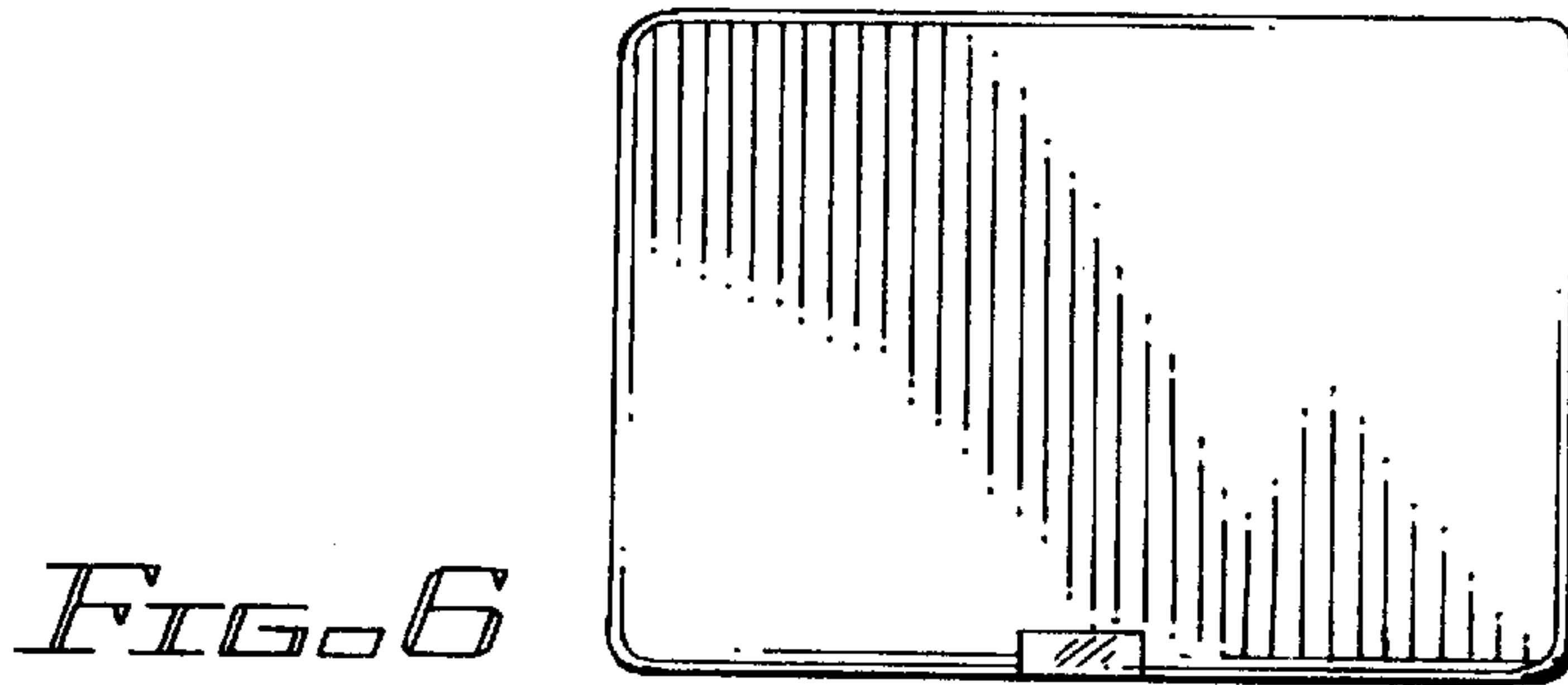

FIG. 6

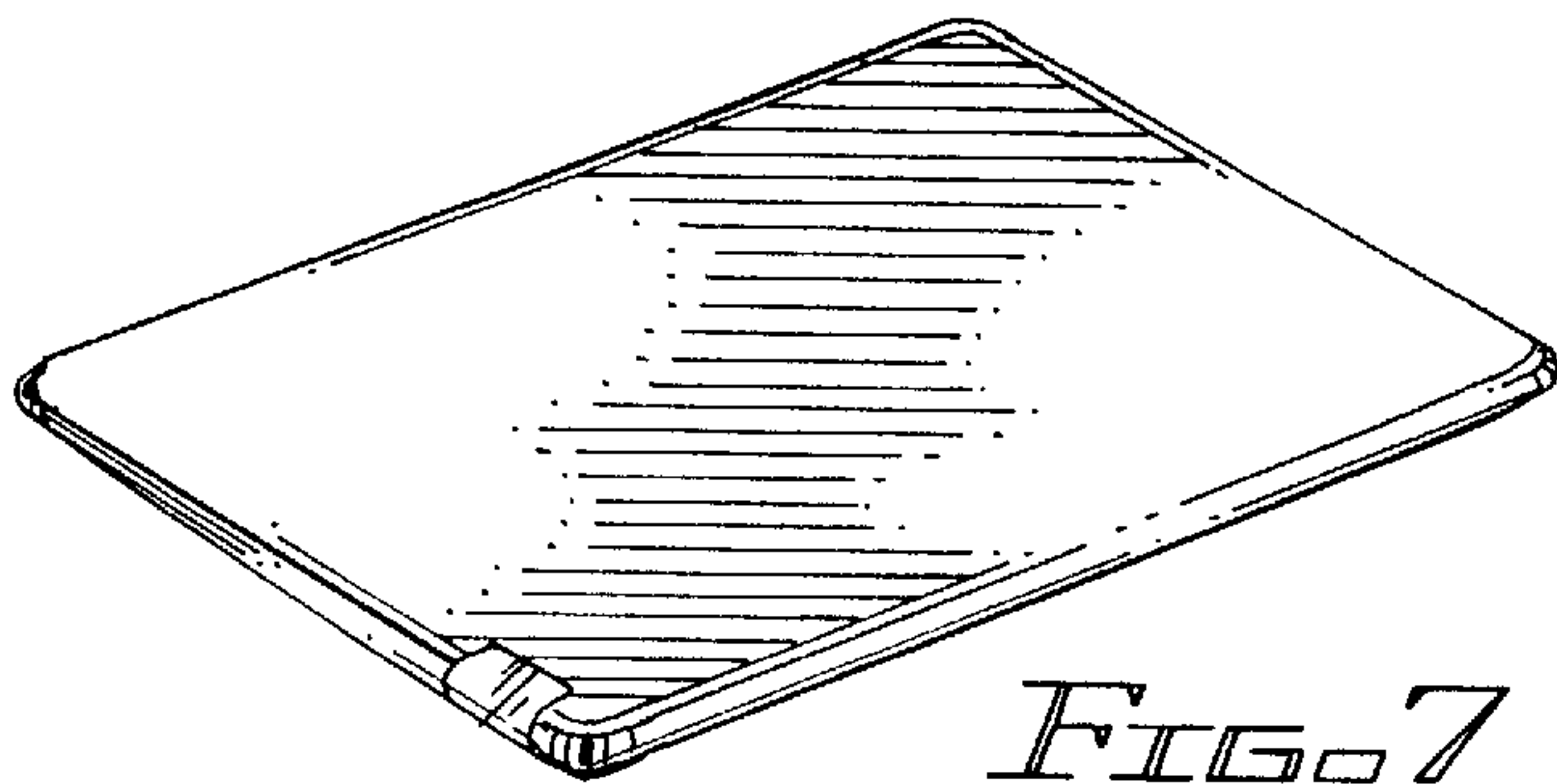

FIG. 7

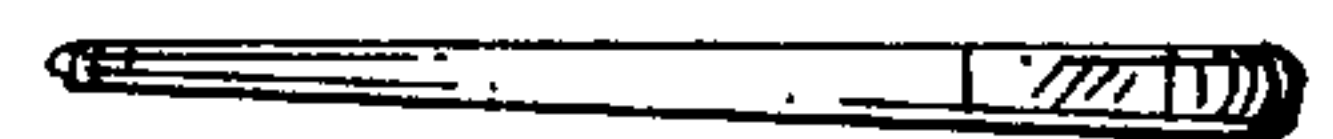

FIG. 8



FIG. 11

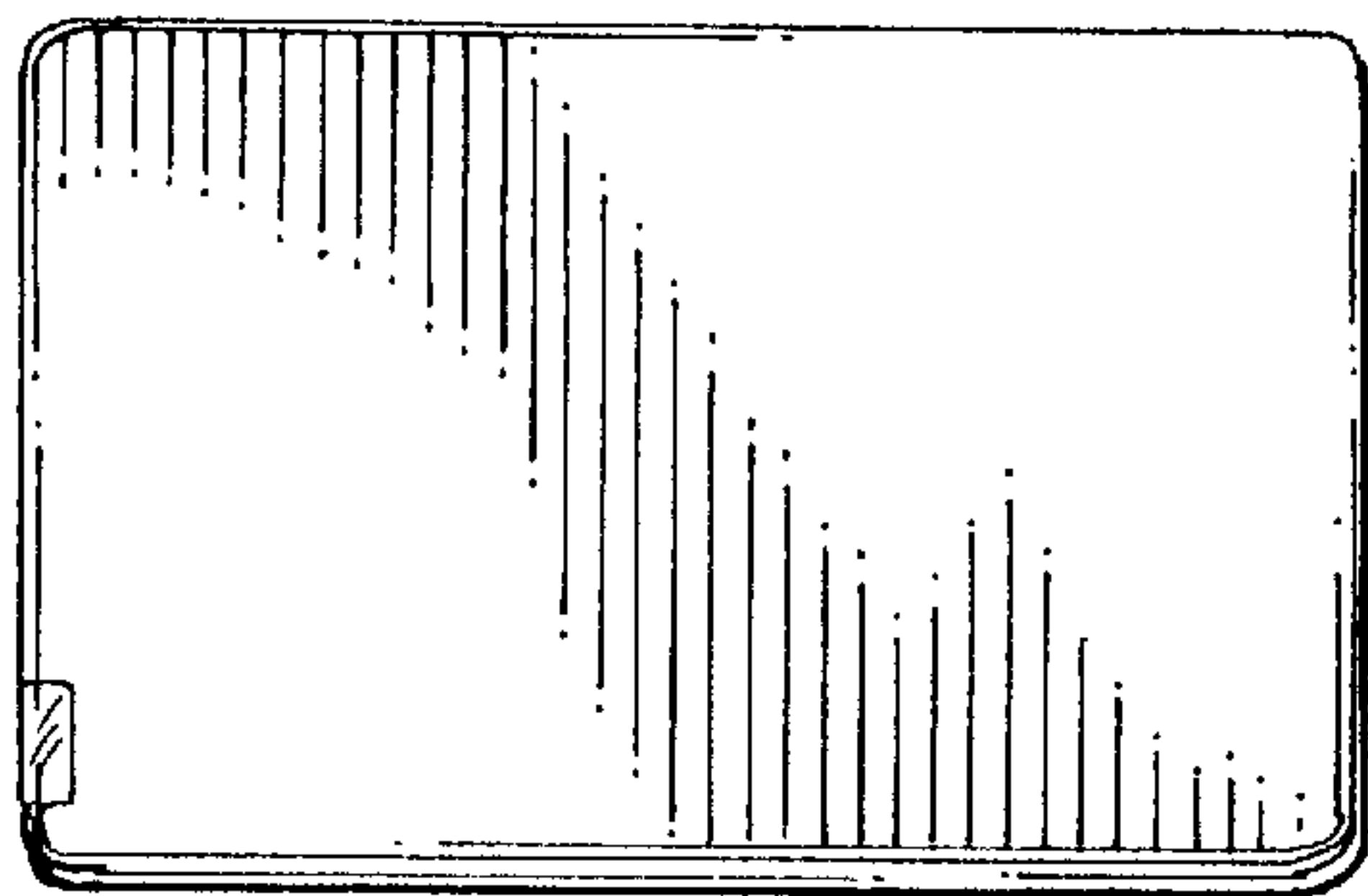

FIG. 9

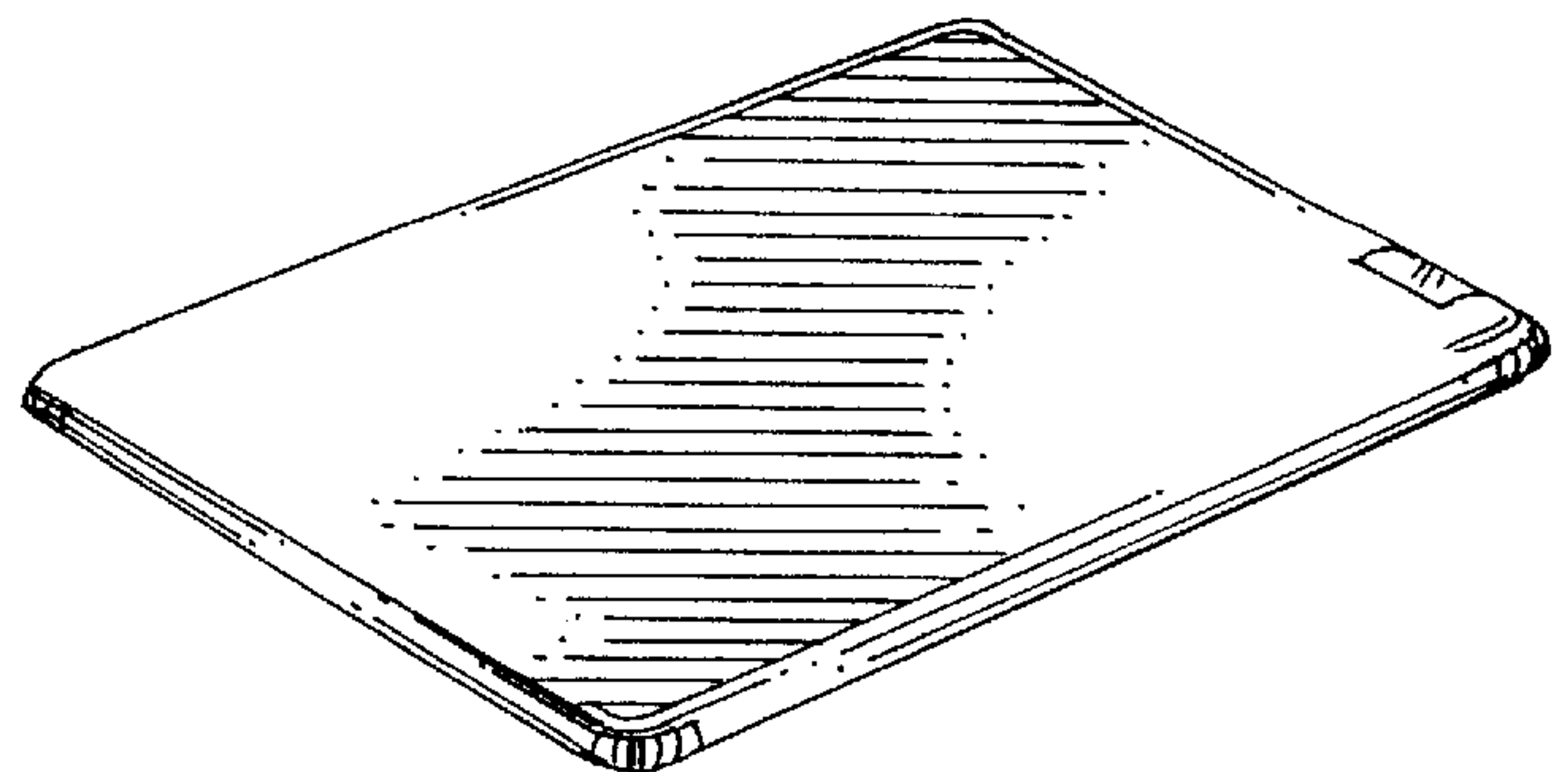

FIG. 10

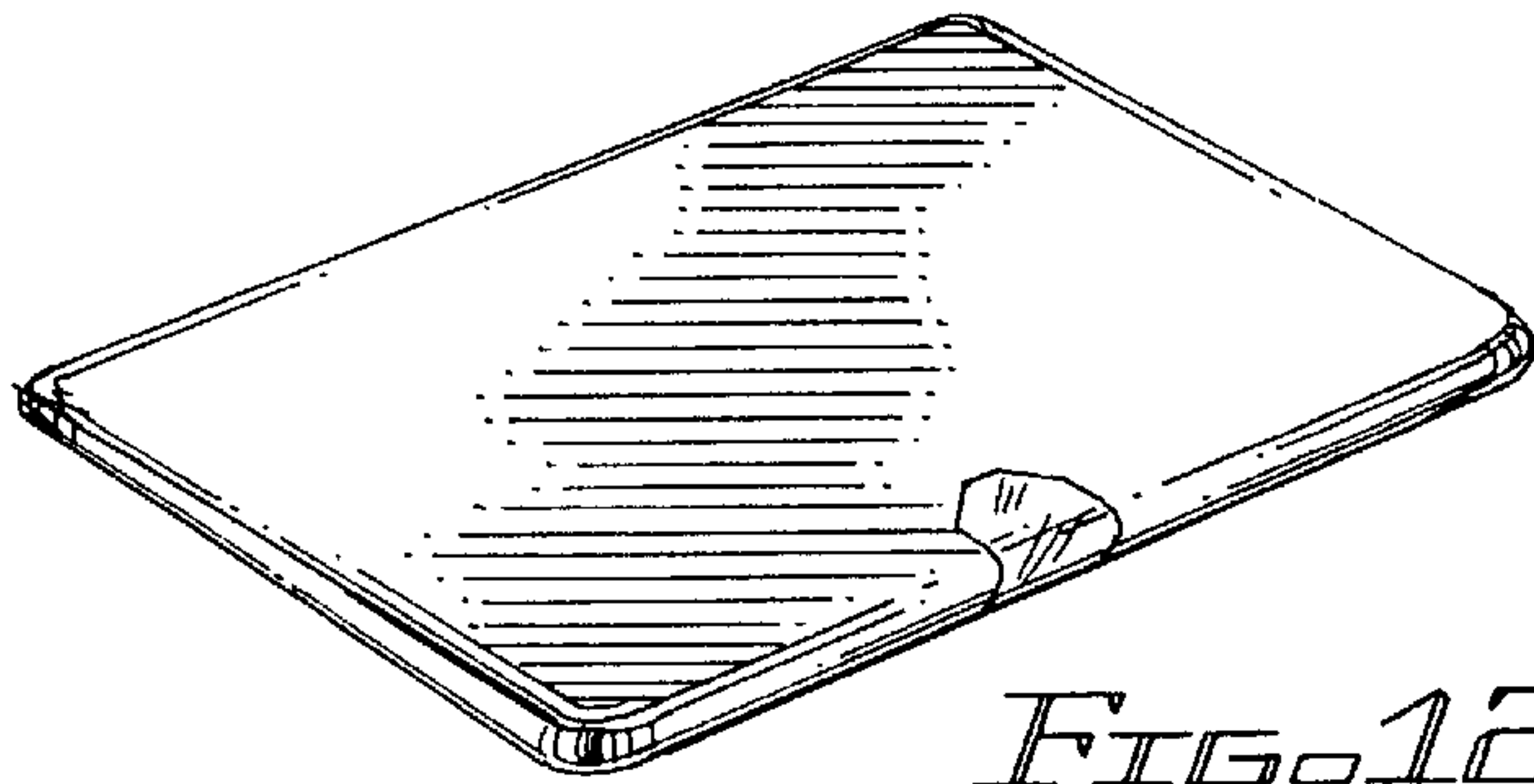

FIG. 12

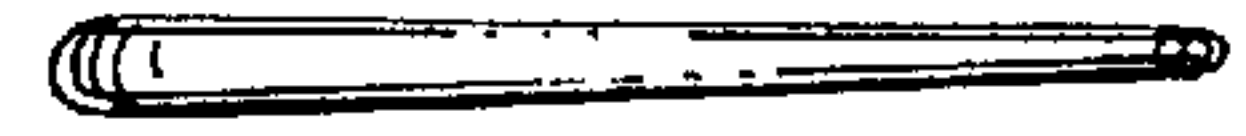

FIG. 13

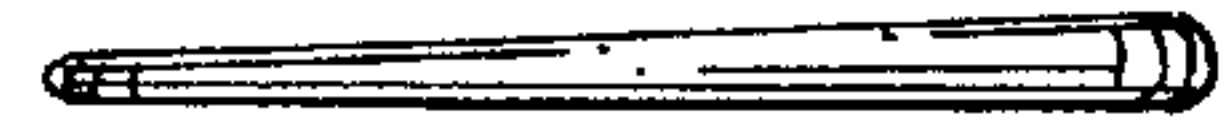

FIG. 14

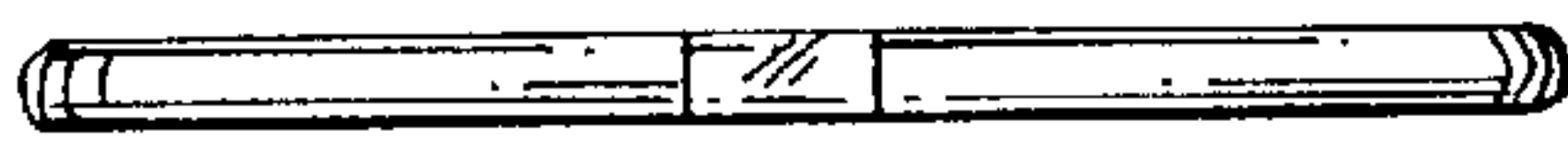

FIG. 15

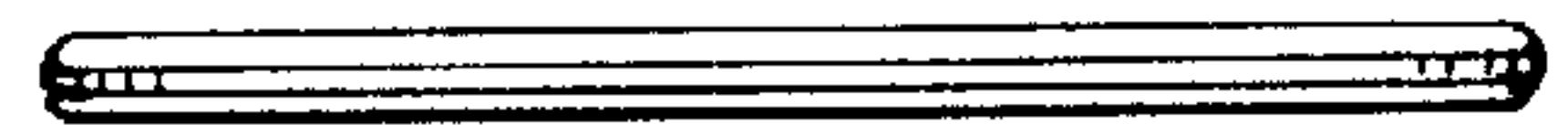

FIG. 16

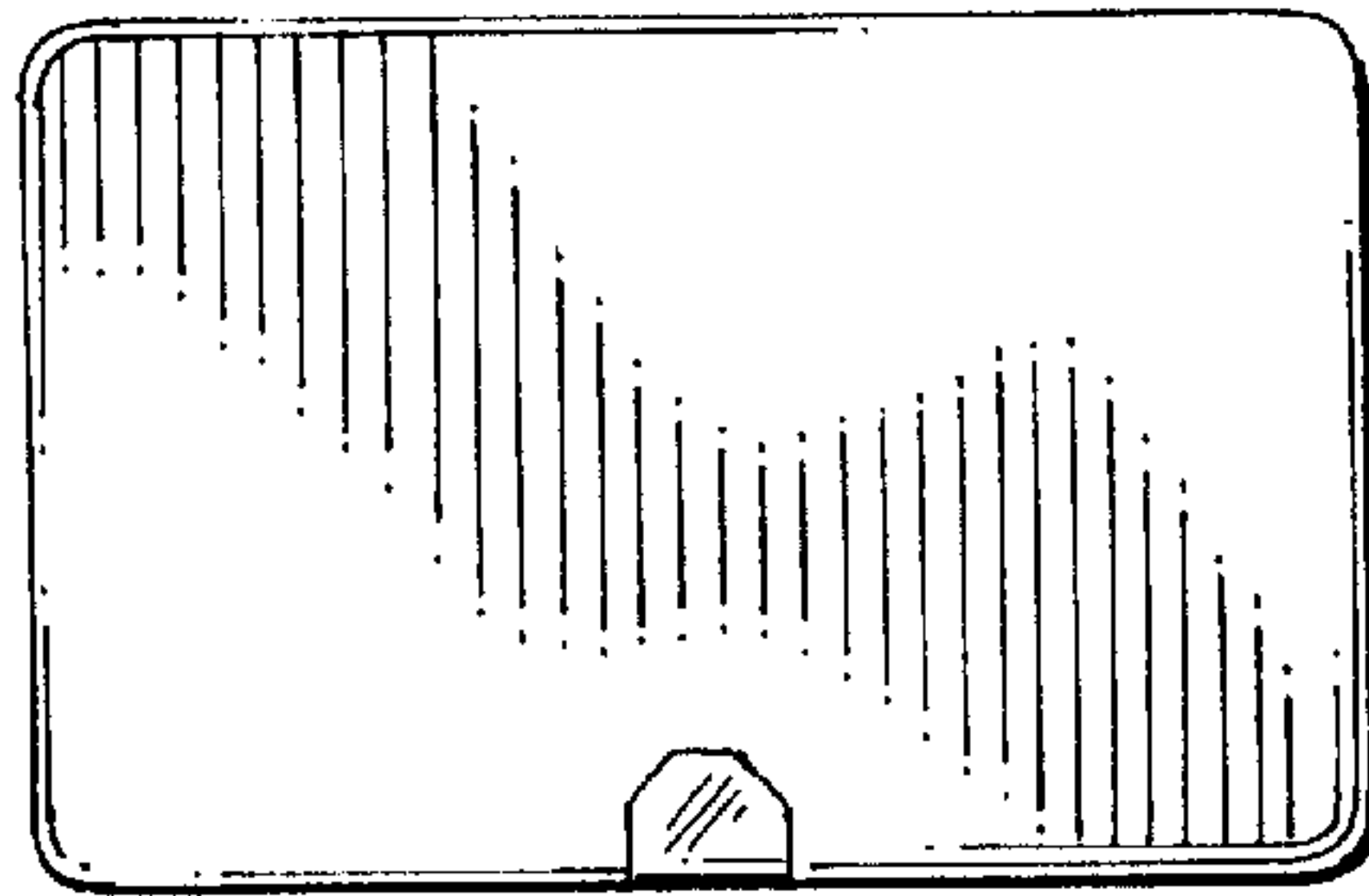

FIG. 17

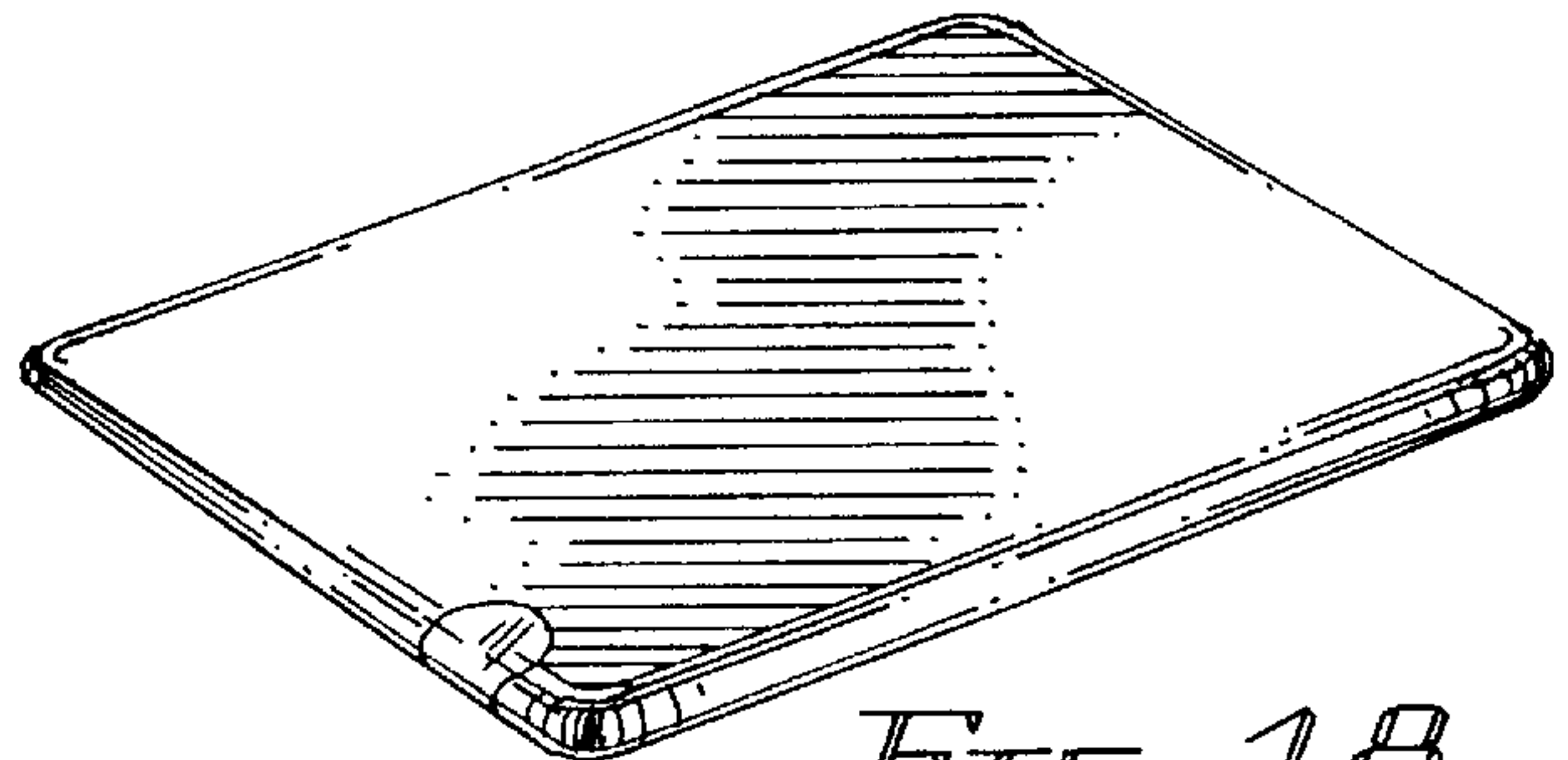

FIG. 18

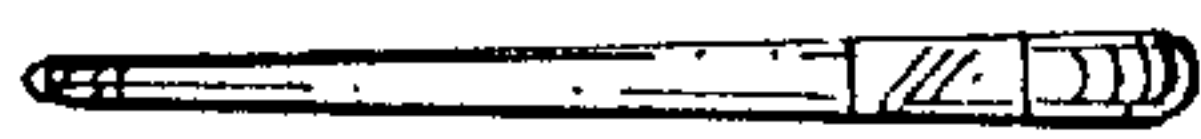

FIG. 19

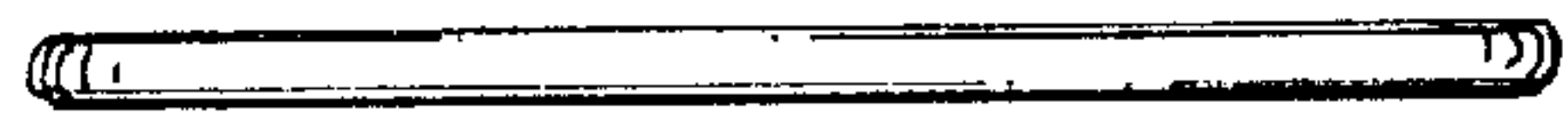

FIG. 21

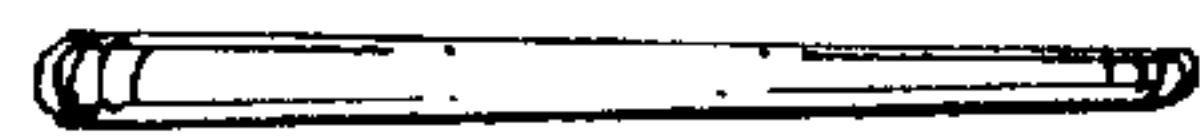

FIG. 20

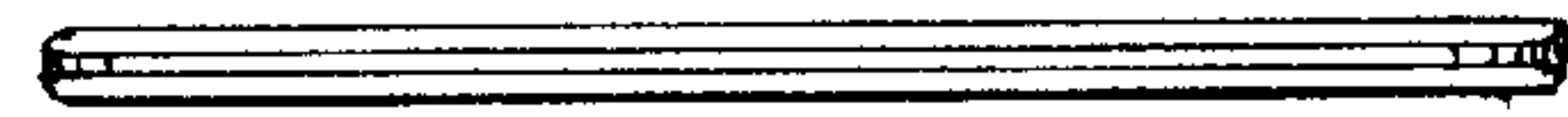

FIG. 22

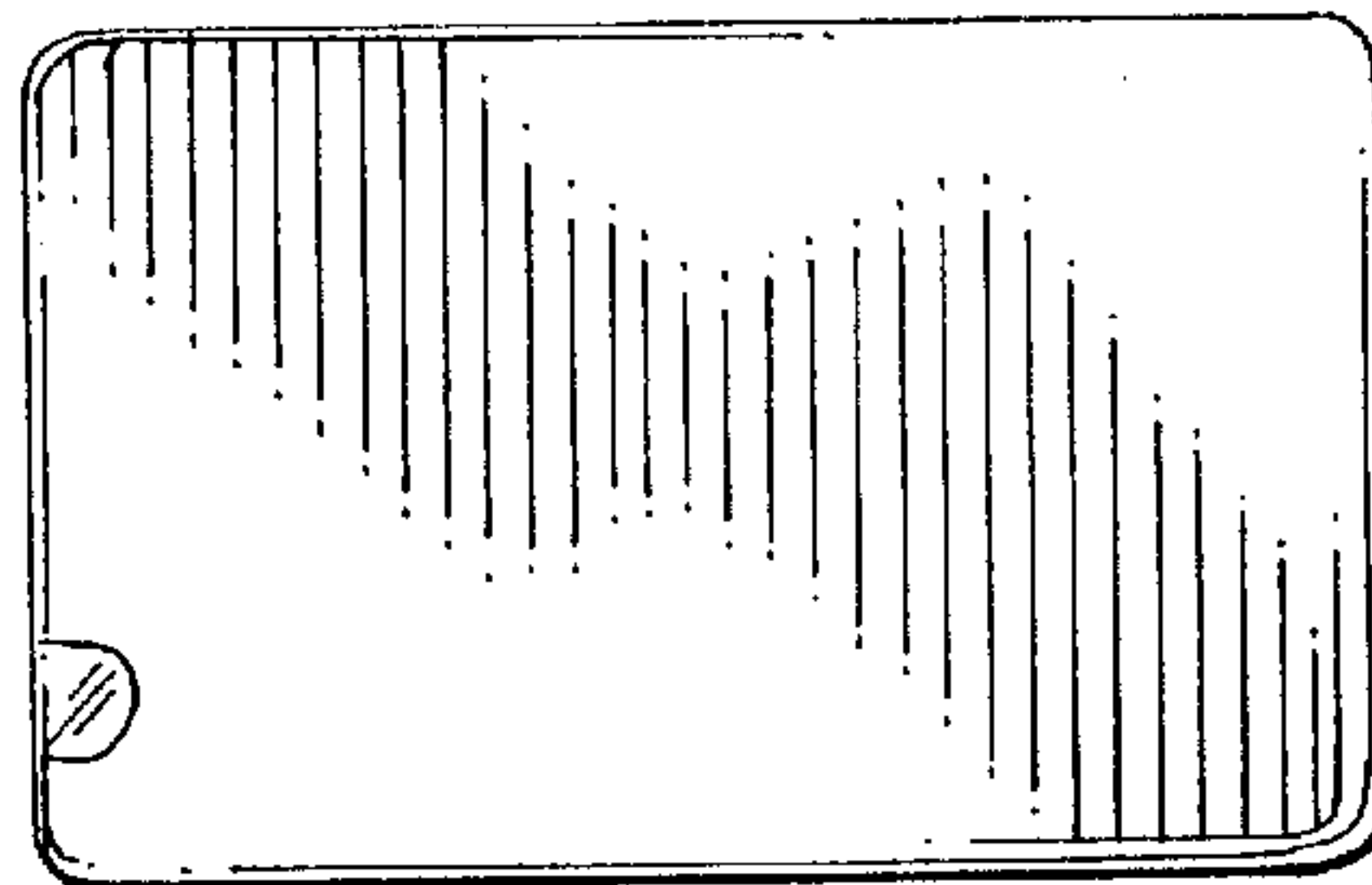

FIG. 23

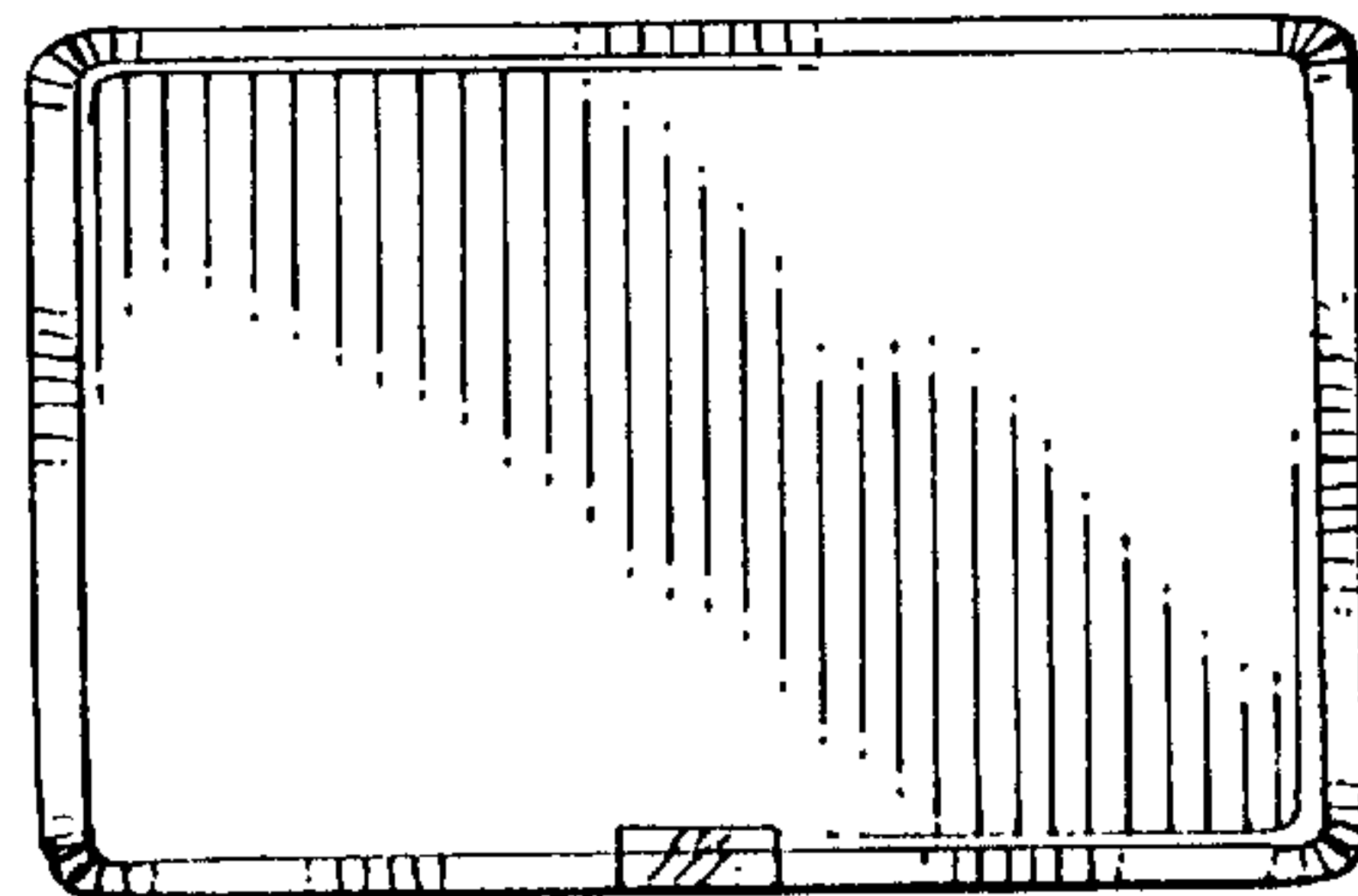
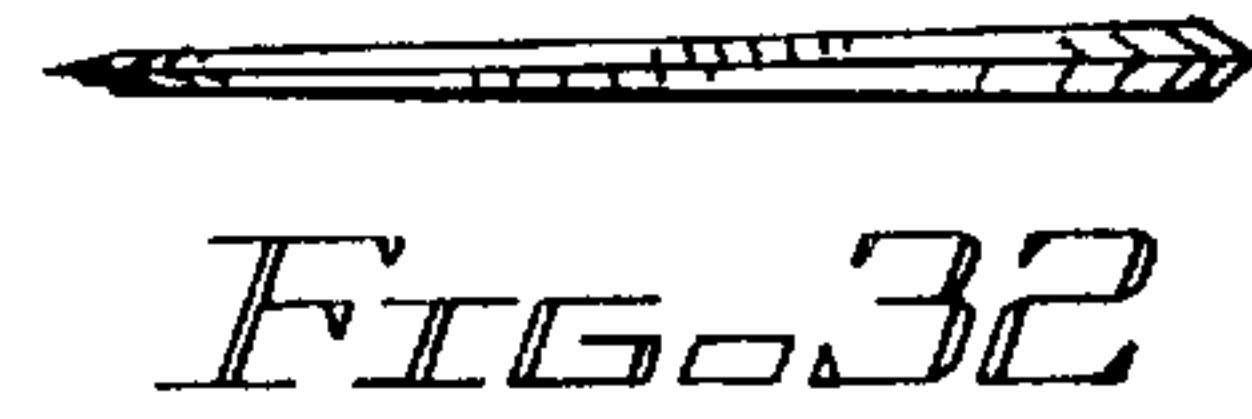
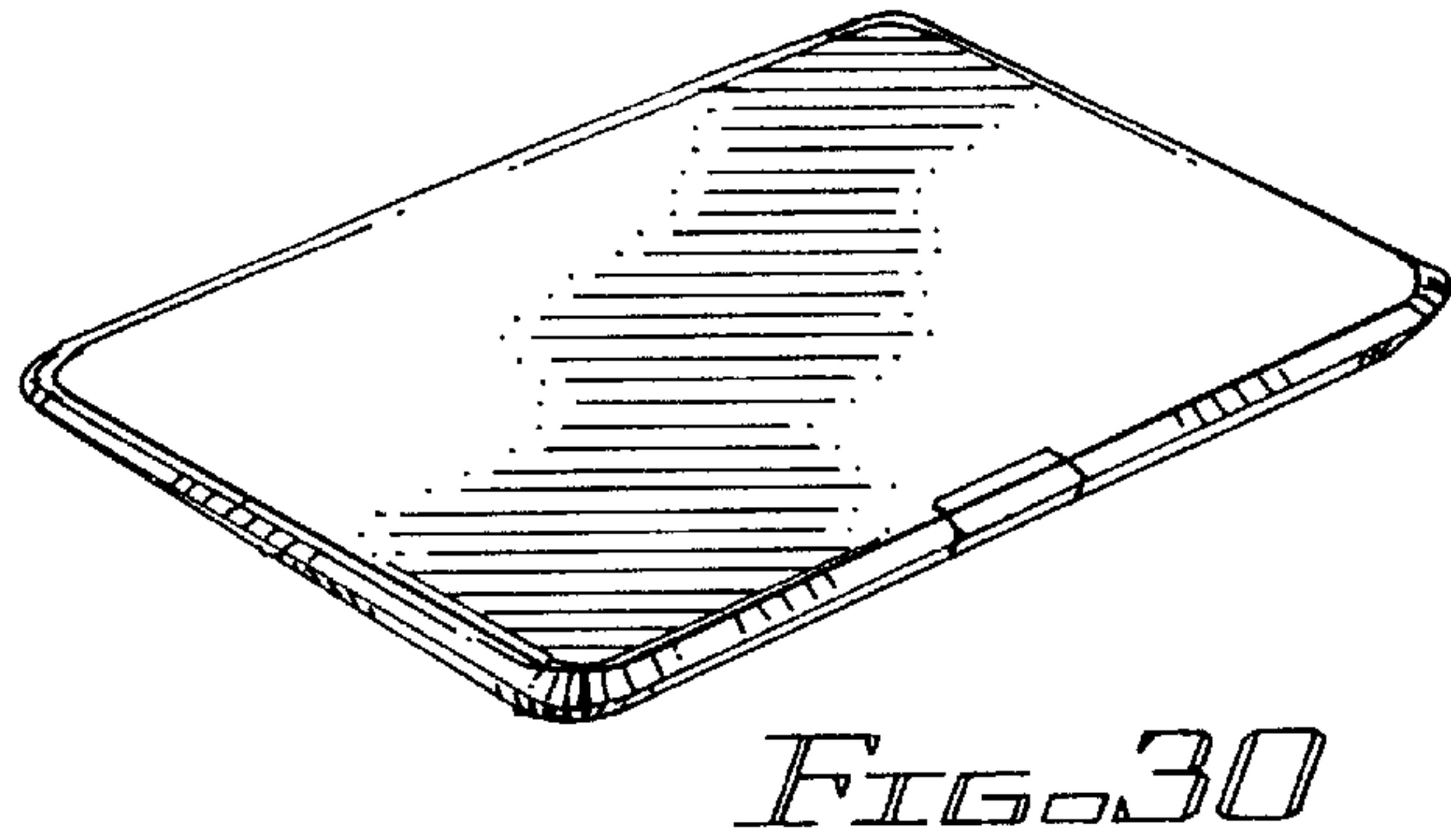
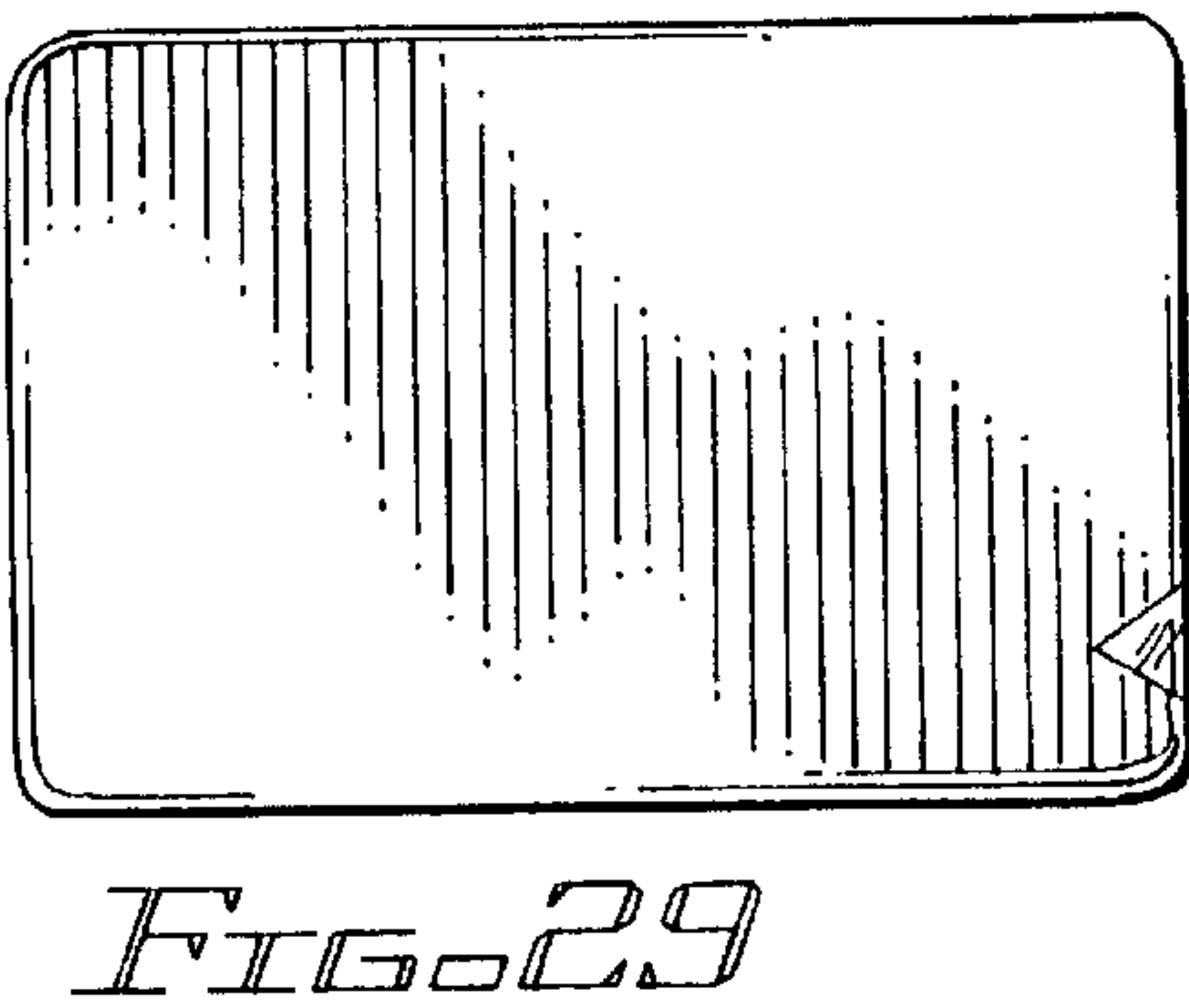
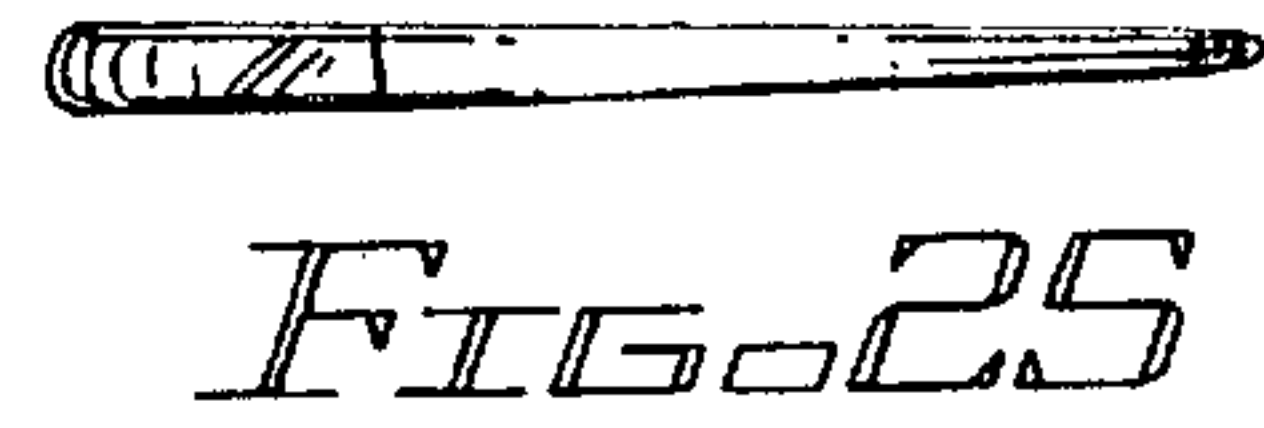
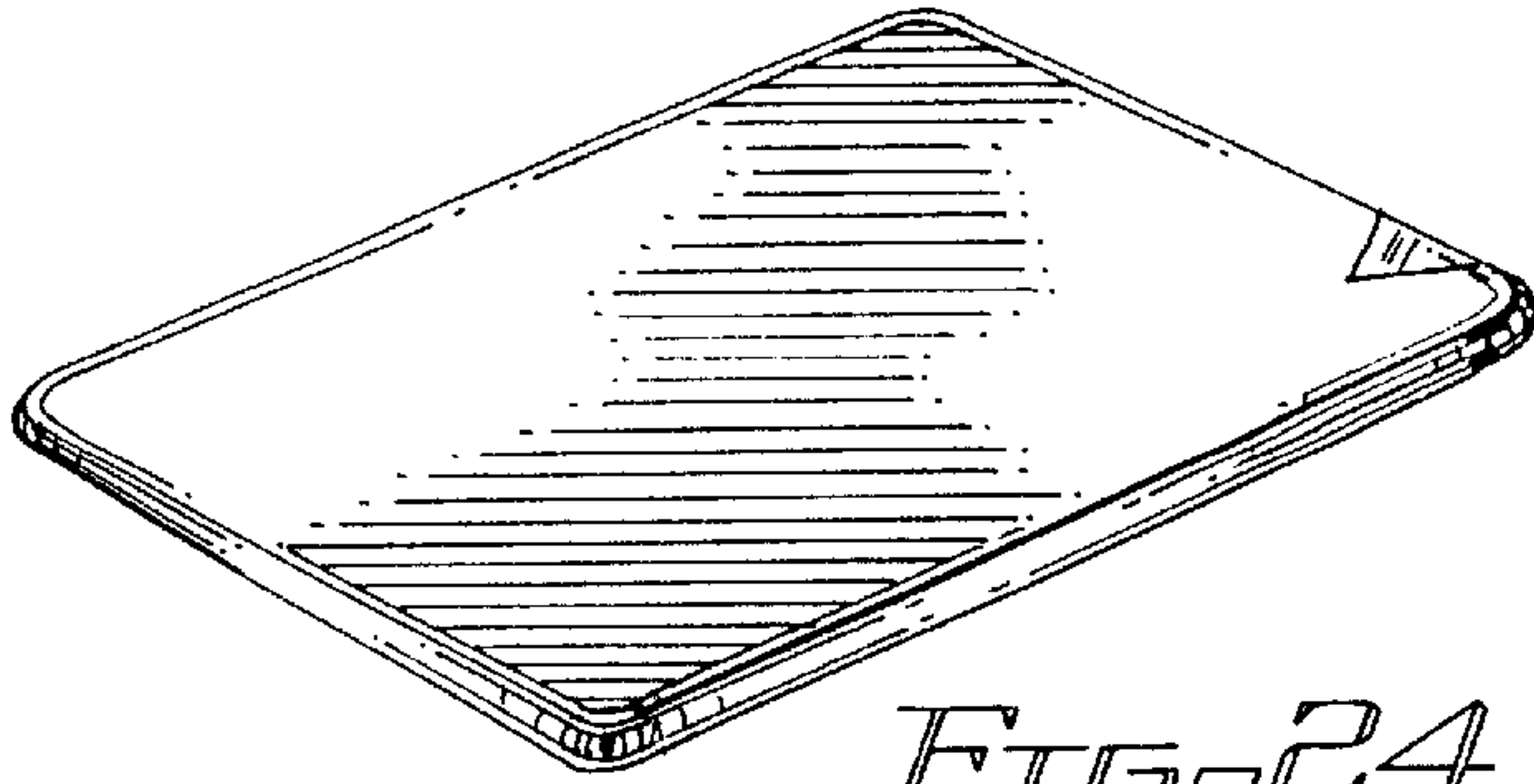

FIG. 35