



US00D410675S

# United States Patent [19] Ohashi

[11] **Patent Number: Des. 410,675**  
[45] **Date of Patent: \*\* Jun. 8, 1999**

[54] **PHOTOCOPIER**

D. 331,595 12/1992 Ishida ..... D18/38  
D. 374,454 10/1996 Naruki et al. .... D18/36

[75] Inventor: **Hiroaki Ohashi**, Tokyo, Japan

[73] Assignee: **Canon Kabushiki Kaisha**, Tokyo, Japan

*Primary Examiner*—Caron D. Veynar  
*Attorney, Agent, or Firm*—Fitzpatrick, Cella, Harper & Scinto

[\*\*] Term: **14 Years**

### [57] CLAIM

[21] Appl. No.: **29/092,048**

The ornamental design for a photocopier, as shown and described.

[22] Filed: **Aug. 11, 1998**

### [30] Foreign Application Priority Data

Feb. 16, 1998 [JP] Japan ..... 10-004031

### DESCRIPTION

[51] **LOC (6) Cl.** ..... **16-03**

FIG. 1 is a front view of a photocopier showing my new design;

[52] **U.S. Cl.** ..... **D18/36**

FIG. 2 is a rear view thereof;

[58] **Field of Search** ..... D18/36-39; D14/107,  
D14/111, 114; 399/1-7, 151; 355/400, 405,  
128

FIG. 3 is a top plan view thereof;

FIG. 4 is a bottom plan view thereof;

FIG. 5 is a left side view thereof;

FIG. 6 is a right side view thereof; and,

FIG. 7 is a perspective view thereof.

### [56] References Cited

#### U.S. PATENT DOCUMENTS

D. 328,609 8/1992 Isida ..... D18/36

**1 Claim, 5 Drawing Sheets**

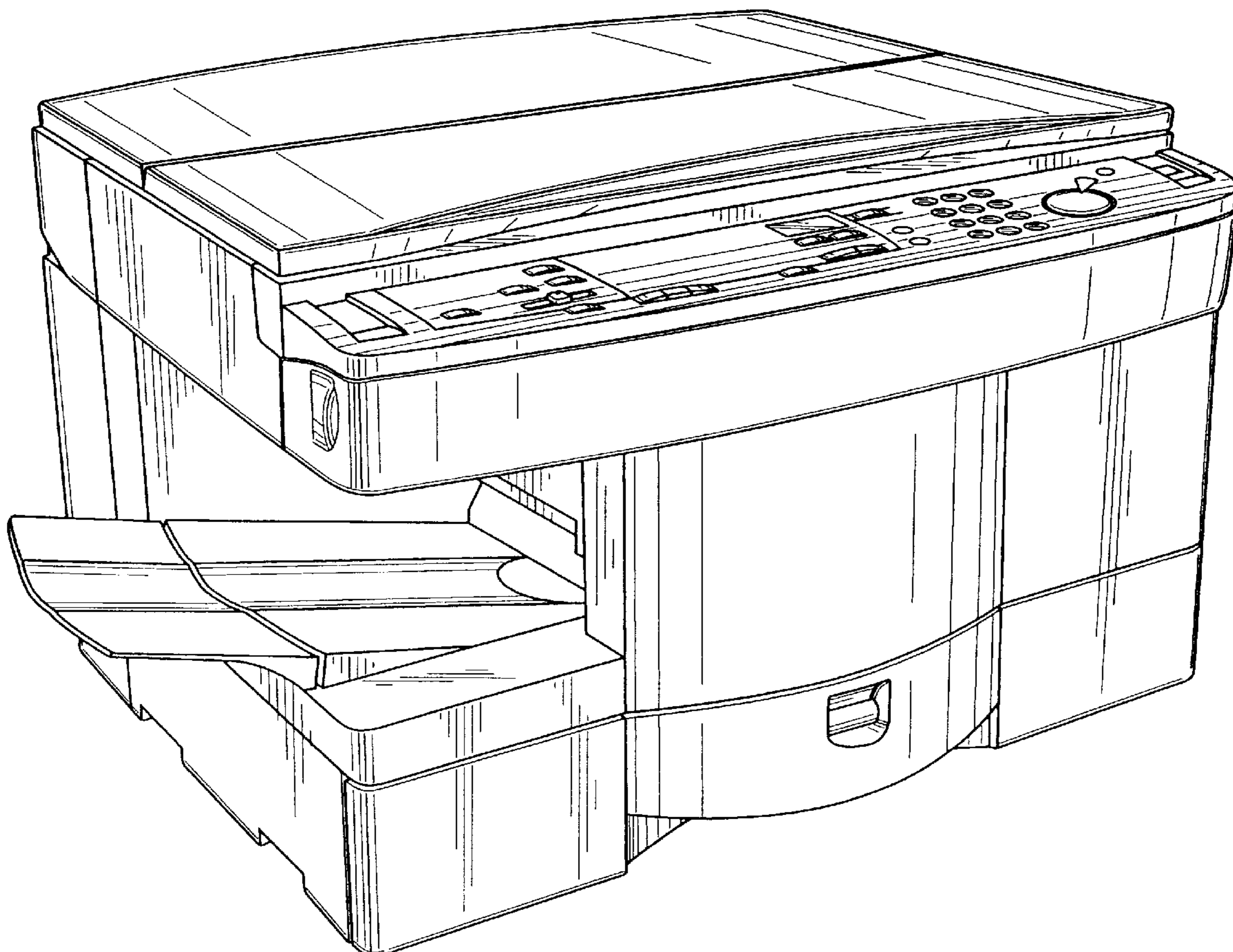

*FIG. 1*

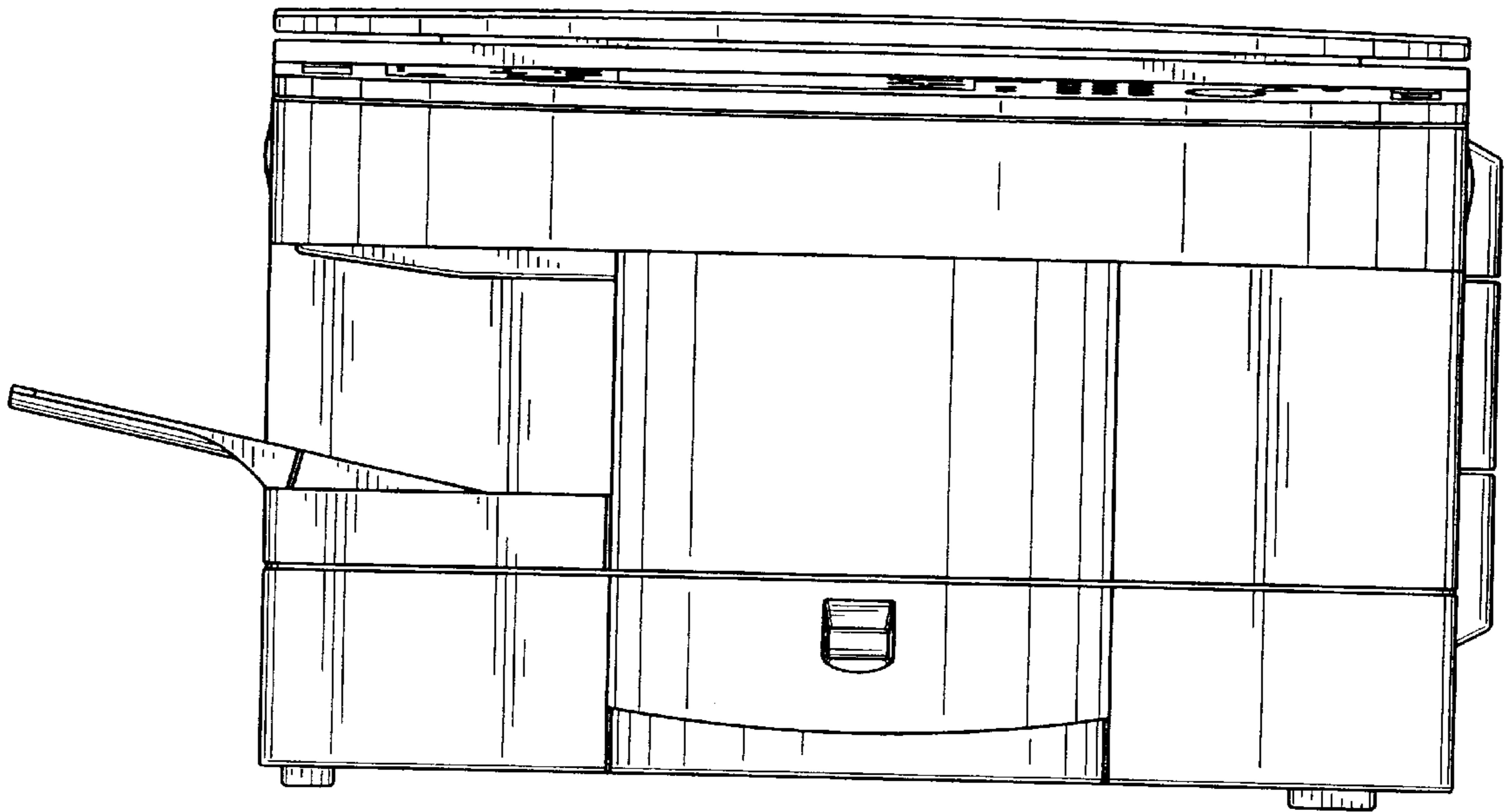

*FIG. 2*

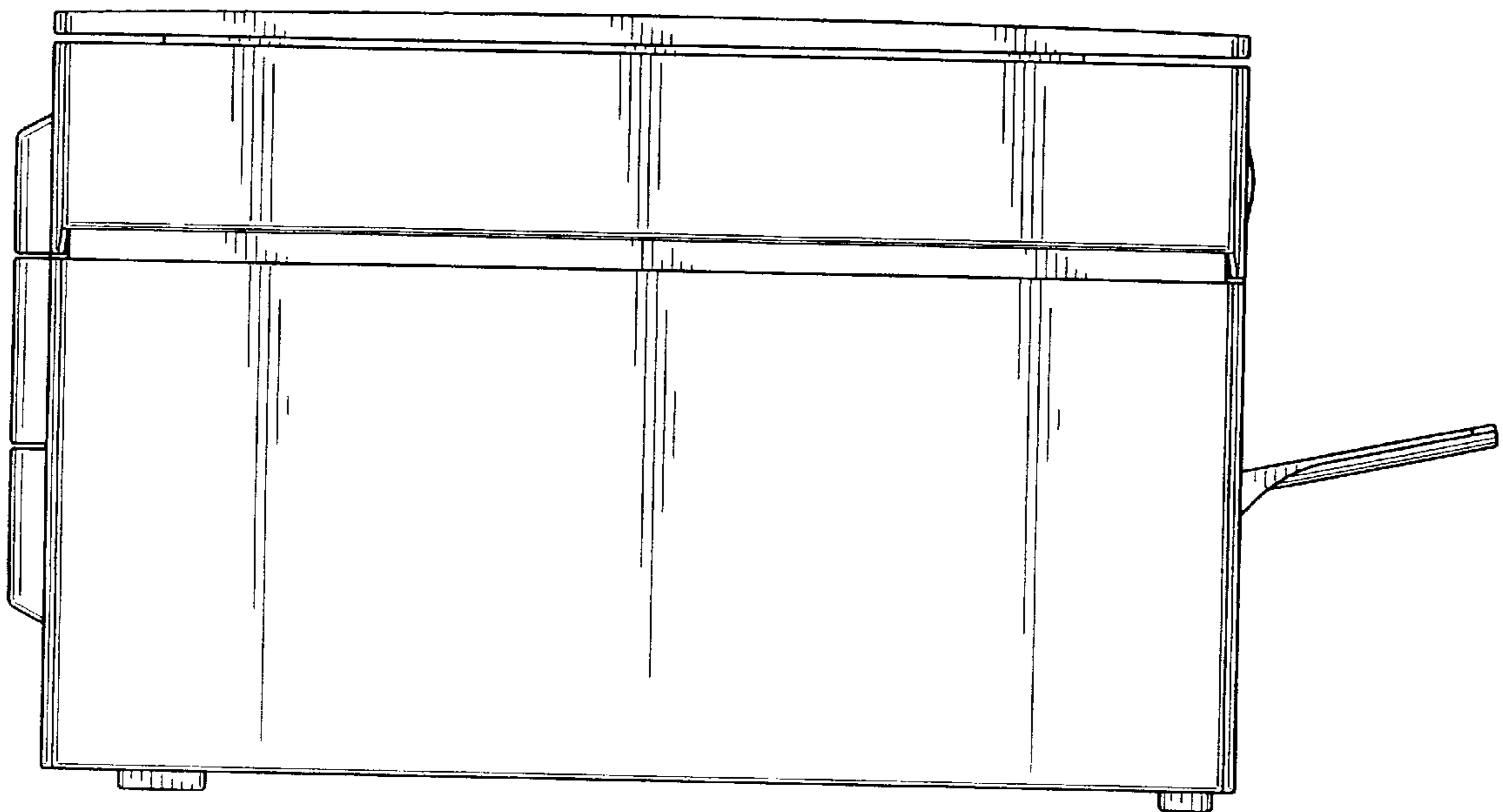
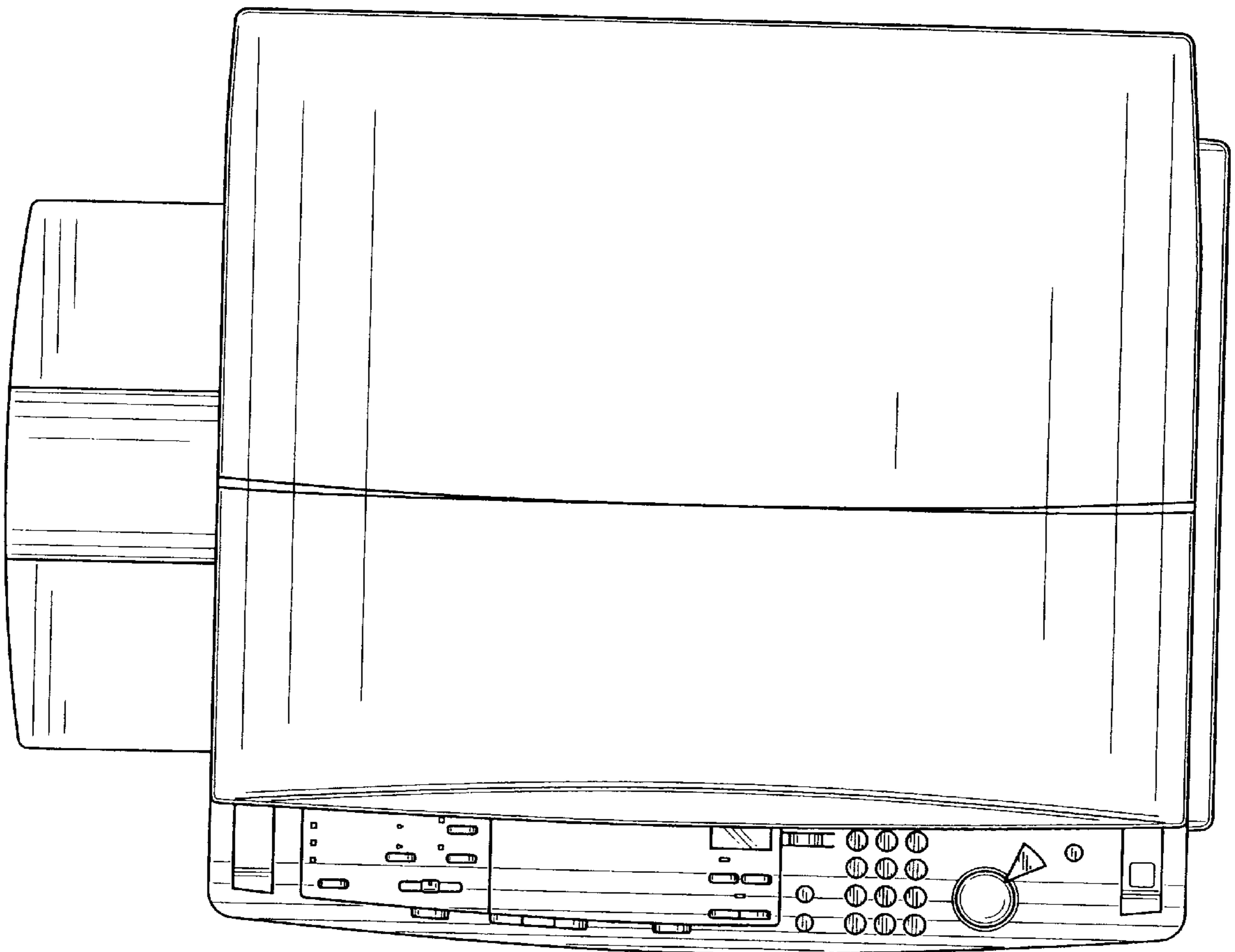
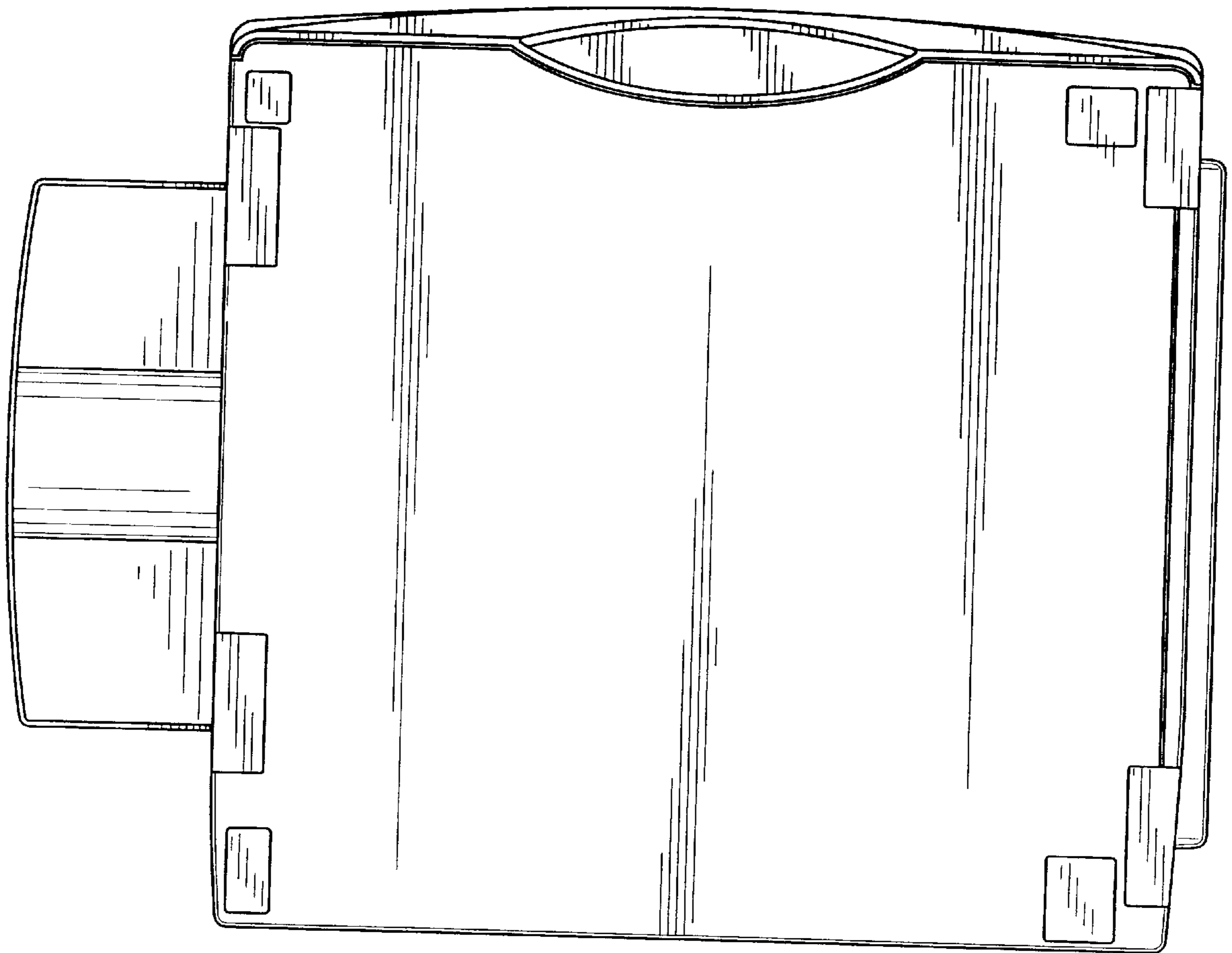

FIG. 3



*FIG. 4*



*FIG. 5*

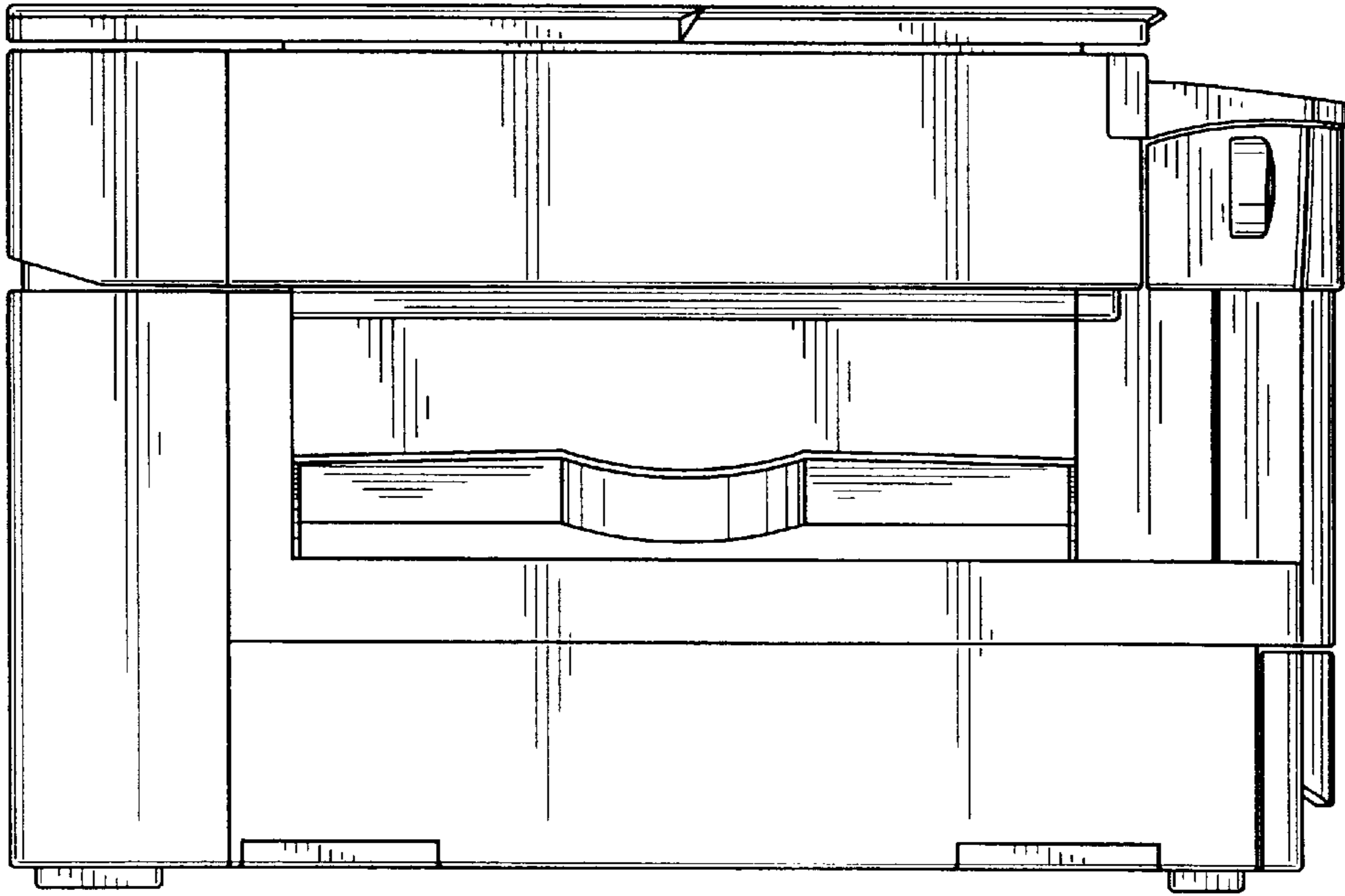

*FIG. 6*

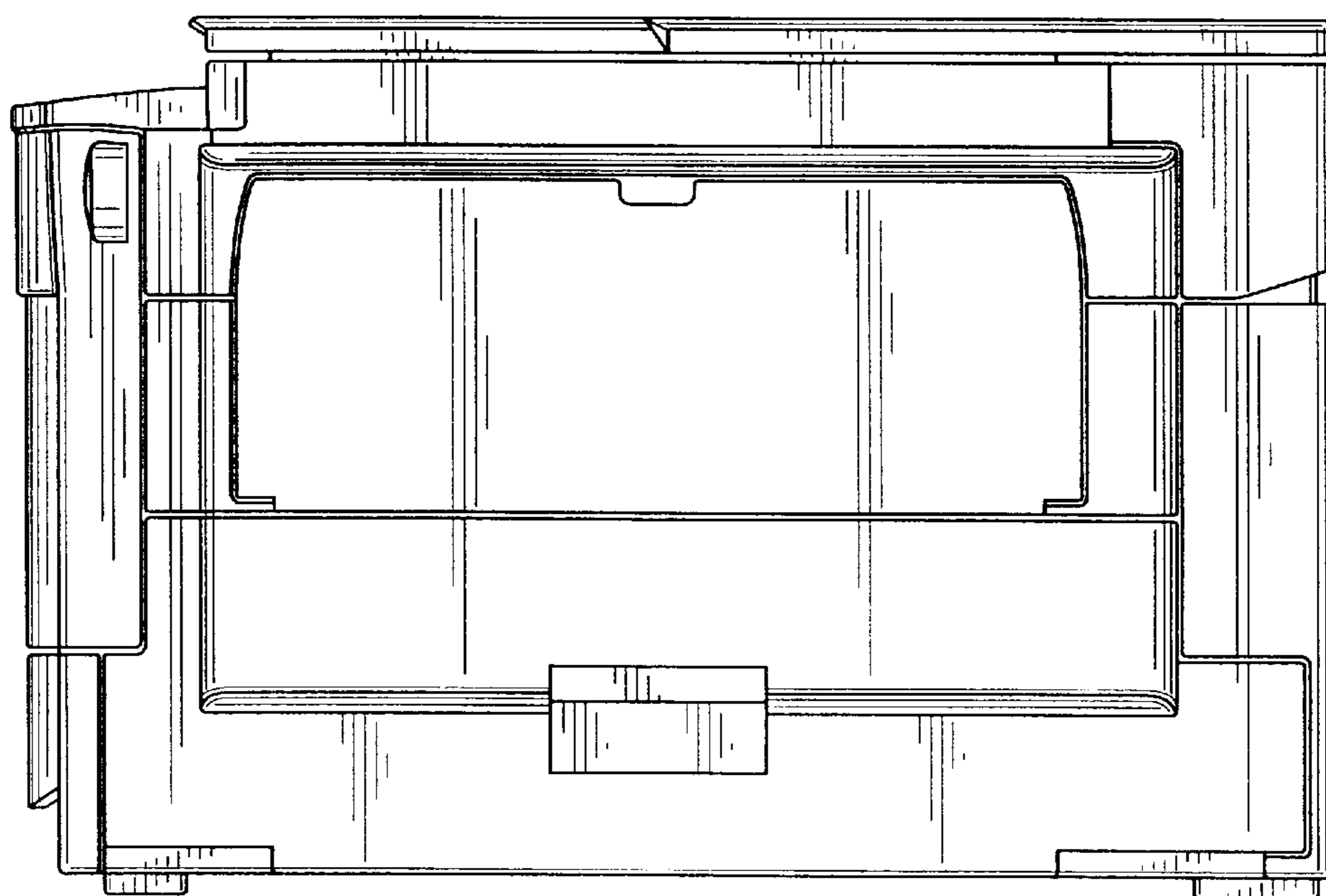

*FIG. 7*

