



US00D410673S

# United States Patent [19]

Martin et al.

[11] Patent Number: **Des. 410,673**

[45] Date of Patent: **\*\* Jun. 8, 1999**

[54] **DOUBLE DAB INK DAUBER**

[76] Inventors: **Becky B. Martin; Shelly D. Nellis,**  
both of 1407 S. Washington St.,  
Roswell, N. Mex. 88201

[\*\*] Term: **14 Years**

[21] Appl. No.: **29/022,298**

[22] Filed: **May 3, 1994**

### Related U.S. Application Data

[63] Continuation of application No. 29/002,813, Dec. 21, 1992,  
abandoned.

[51] **LOC (6) Cl.** ..... **19-02**

[52] **U.S. Cl.** ..... **D18/15; D19/36; D19/51;**  
D19/41; D19/47

[58] **Field of Search** ..... D18/15, 18, 17;  
D19/41, 43, 45, 51, 54, 36, 47; 273/148 R;  
401/190, 198, 202, 130, 34

### [56] References Cited

#### U.S. PATENT DOCUMENTS

D. 279,992	8/1985	Gribb	.....	D19/43
D. 295,878	5/1988	Lovell	.....	D19/43
D. 305,964	2/1990	Hurwitz	.....	D4/135
D. 341,387	11/1993	Koneval	.....	D18/15
D. 389,188	1/1998	Conforti et al.	.....	D19/51

D. 389,965	1/1998	Saladino	.....	D19/51
3,459,484	8/1969	Abrams	.....	401/206
4,133,614	1/1979	Baginski et al.	.....	401/206
4,792,252	12/1988	Kremer et al.	.....	401/206
4,863,171	9/1989	Rocheleau	.....	273/148 R
5,222,823	6/1993	Conforti	.....	401/196

### OTHER PUBLICATIONS

Brochure distributed by American Inventors Corporation  
approximately during Feb. 1993.

*Primary Examiner*—Louis S. Zarfaz

*Assistant Examiner*—G. Andoll

### [57] CLAIM

The ornamental design for a double dab ink dauber, as  
shown and described.

### DESCRIPTION

FIG. 1 is a front elevational exploded view of the double dab  
ink dauber showing my new design;  
FIG. 2 is a rear elevational exploded view thereof;  
FIG. 3 is a left side elevational view thereof;  
FIG. 4 is a right side elevational view thereof;  
FIG. 5 is a top plan exploded view thereof; and,  
FIG. 6 is a bottom plan exploded view thereof.

The undisclosed surfaces of the double dab ink dauber form  
no part of the claimed design.

**1 Claim, 3 Drawing Sheets**

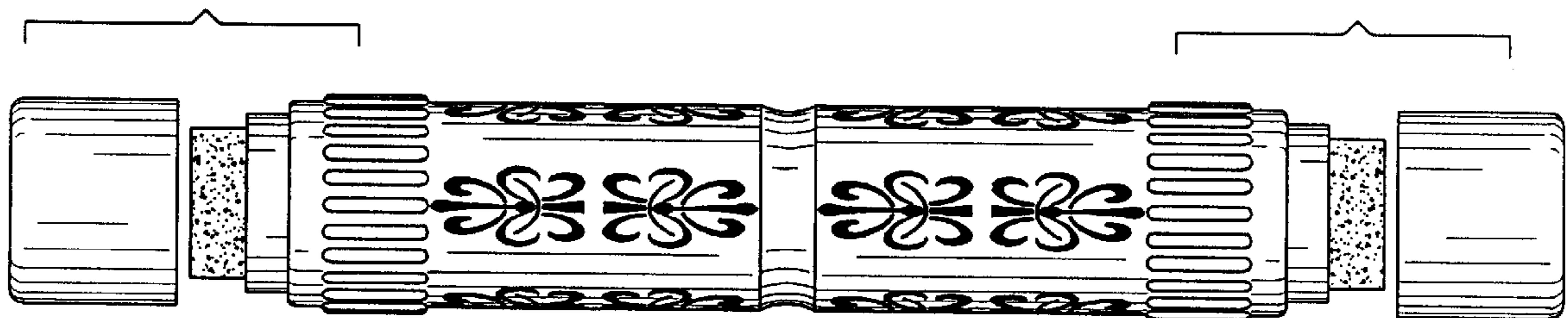

FIG. 1

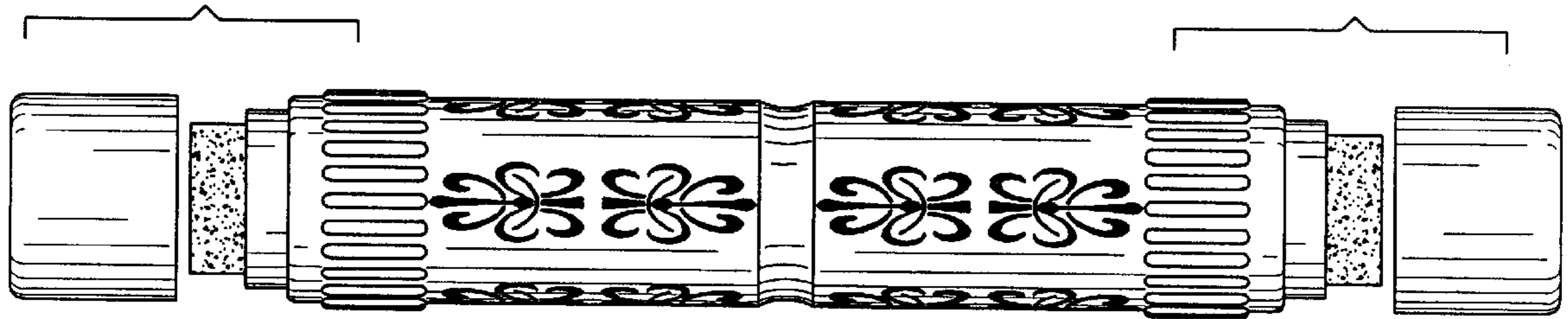
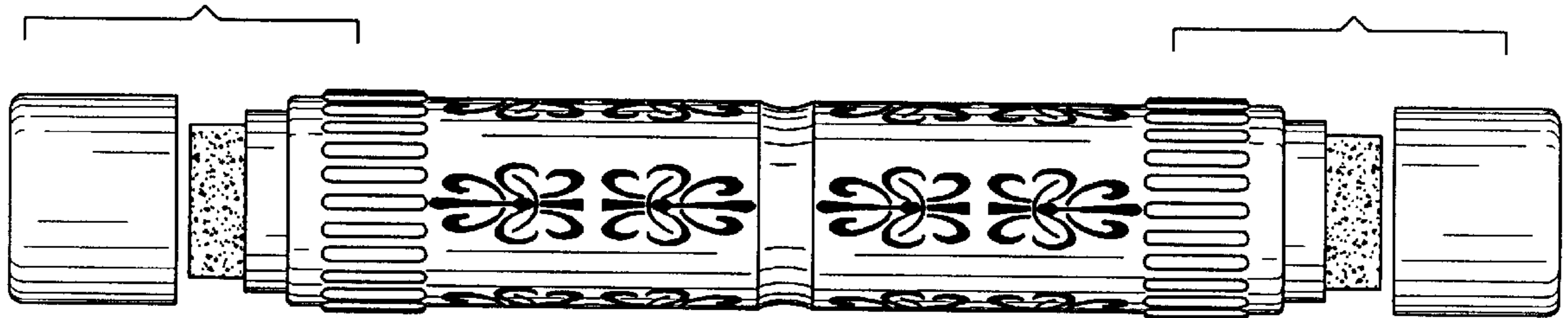
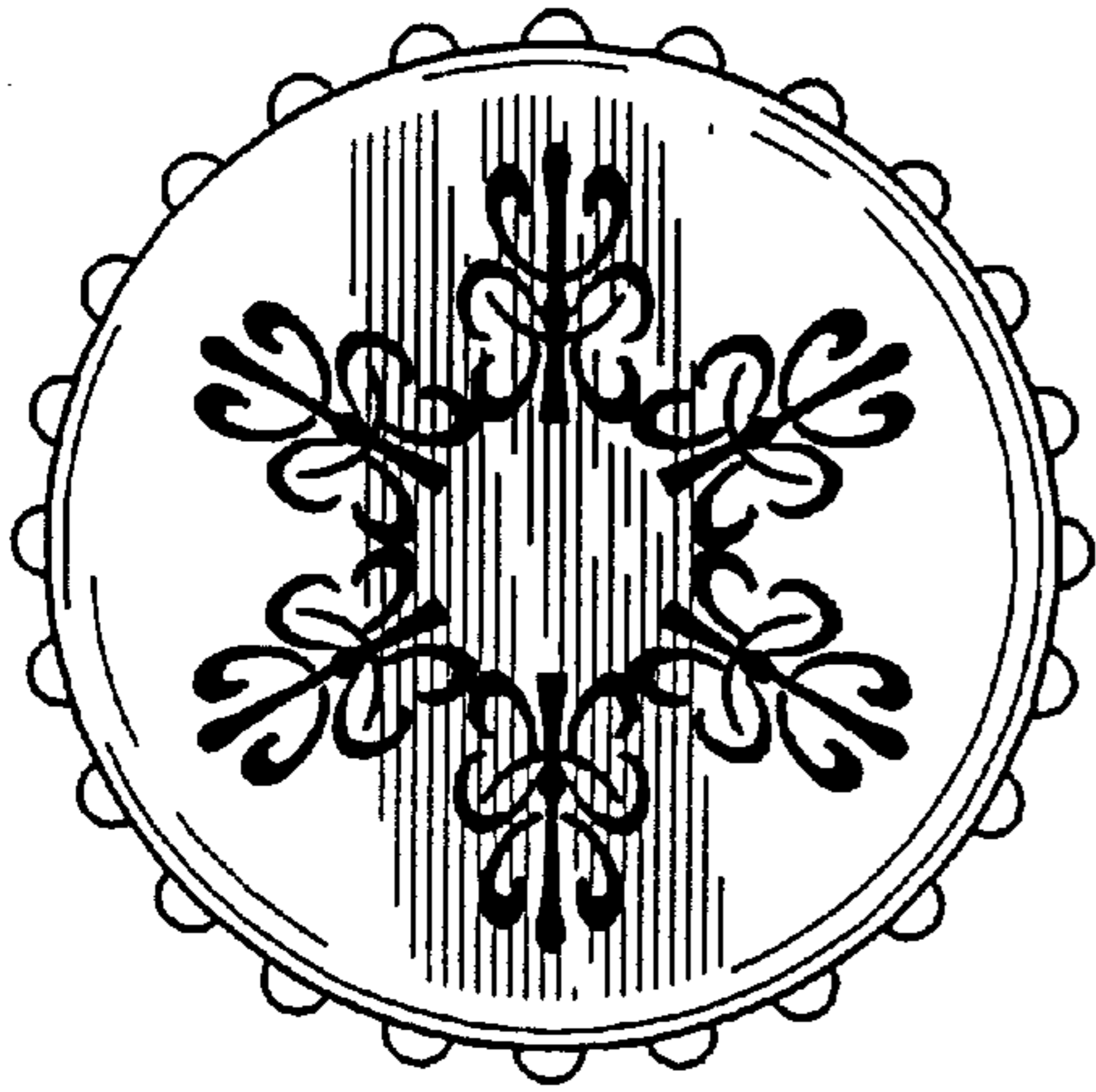

FIG. 2



*FIG. 3*



*FIG. 4*

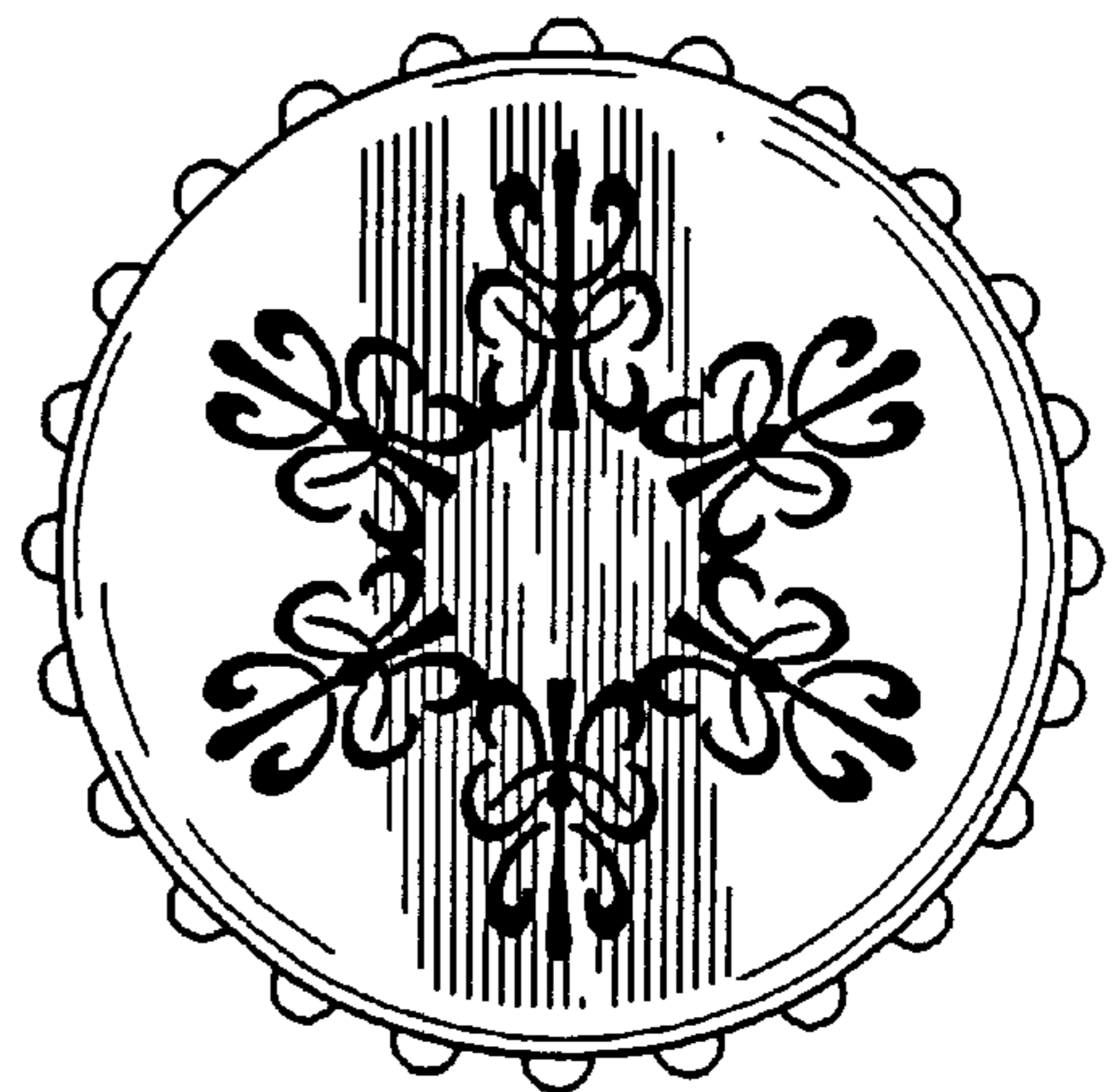

FIG. 5

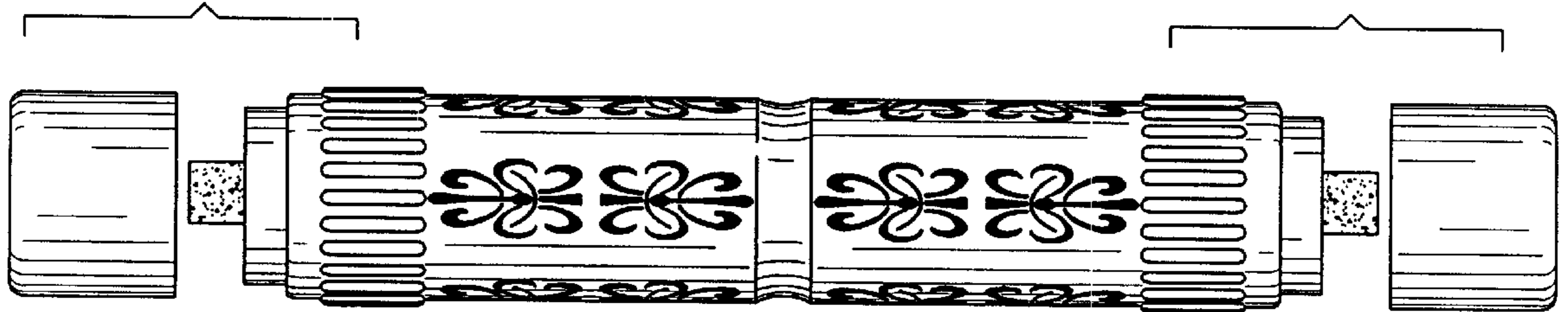
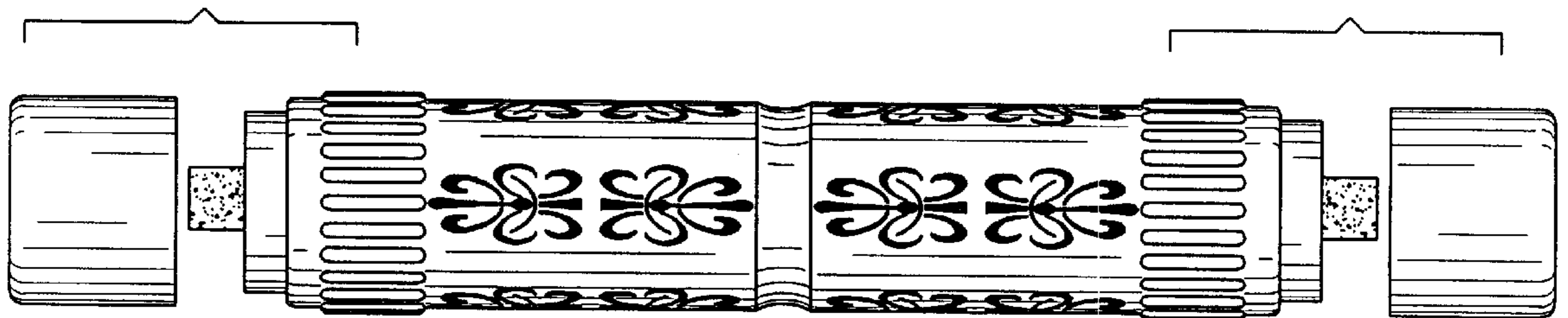

FIG. 6



UNITED STATES PATENT AND TRADEMARK OFFICE  
**CERTIFICATE OF CORRECTION**

PATENT NO. : Des. 410,673  
DATED : June 8, 1999  
INVENTOR(S) : Martin et al.

Page 1 of 5

It is certified that error appears in the above-identified patent and that said Letters Patent is hereby corrected as shown below:

The title page should be deleted to appear as per attached title page.

Please delete drawing sheets 1-3 and substitute drawing sheets 1-3 as per attached.

Signed and Sealed this  
Thirty-first Day of August, 1999

*Attest:*



Q. TODD DICKINSON

*Attesting Officer*

*Acting Commissioner of Patents and Trademarks*



US00D410673S

**United States Patent** [19]

Martin et al.

[11] Patent Number: **Des. 410,673**

[45] Date of Patent: **\*\* Jun. 8, 1999**

[54] **DOUBLE DAB INK DAUBER**

[76] Inventors: **Becky B. Martin; Shelly D. Nellis**,  
both of 1407 S. Washington St.,  
Roswell, N. Mex. 88201

[\*\*] Term: **14 Years**

[21] Appl. No.: **29/022,298**

[22] Filed: **May 3, 1994**

**Related U.S. Application Data**

[63] Continuation of application No. 29/002,813, Dec. 21, 1992,  
abandoned.

[51] **LOC (6) Cl.** ..... **19-02**

[52] **U.S. Cl.** ..... **D18/15; D19/36; D19/51;**  
**D19/41; D19/47**

[58] **Field of Search** ..... **D18/15, 18, 17;**  
**D19/41, 43, 45, 51, 54, 36, 47; 273/148 R;**  
**401/190, 198, 202, 130, 34**

[56] **References Cited**

**U.S. PATENT DOCUMENTS**

D. 279,992	8/1985	Gribb	.....	D19/43
D. 295,878	5/1988	Lovell	.....	D19/43
D. 305,964	2/1990	Hurwitz	.....	D4/135
D. 341,387	11/1993	Koneval	.....	D18/15
D. 389,188	1/1998	Conforti et al.	.....	D19/51

D. 389,965	1/1998	Saladino	.....	D19/51
3,459,484	8/1969	Abrams	.....	401/206
4,133,614	1/1979	Baginski et al.	.....	401/206
4,792,252	12/1988	Kremer et al.	.....	401/206
4,863,171	9/1989	Rocheleau	.....	273/148 R
5,222,823	6/1993	Conforti	.....	401/196

**OTHER PUBLICATIONS**

Brochure distributed by American Inventors Corporation  
approximately during Feb. 1993.

*Primary Examiner*—Louis S. Zarfaz

*Assistant Examiner*—G. Andoll

[57] **CLAIM**

The ornamental design for a double dab ink dauber, as  
shown and described.

**DESCRIPTION**

FIG. 1 is a front elevational exploded view of the double dab  
ink dauber showing my new design;  
FIG. 2 is a rear elevational exploded view thereof;  
FIG. 3 is a left side elevational view thereof;  
FIG. 4 is a right side elevational view thereof;  
FIG. 5 is a top plan exploded view thereof; and,  
FIG. 6 is a bottom plan exploded view thereof.  
The undisclosed surfaces of the double dab ink dauber form  
no part of the claimed design.

**1 Claim, 3 Drawing Sheets**

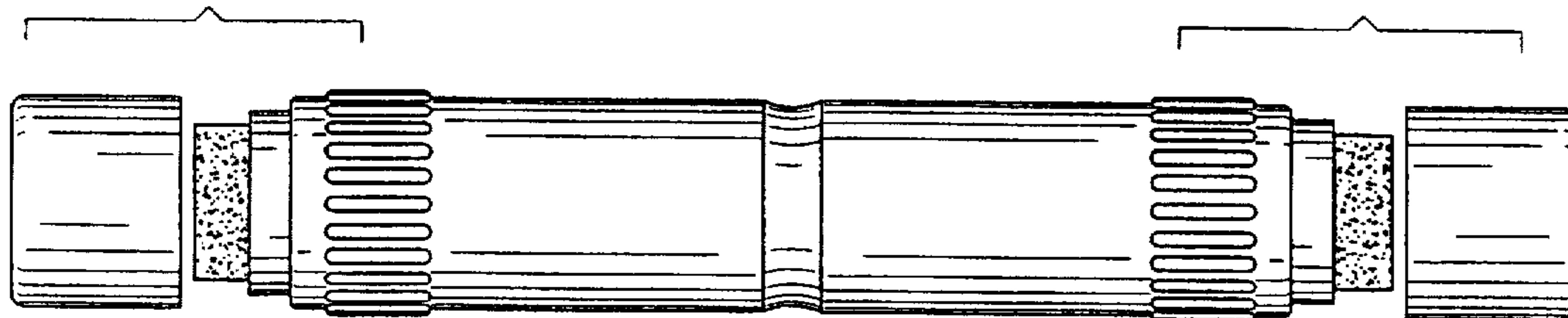

FIG. 1

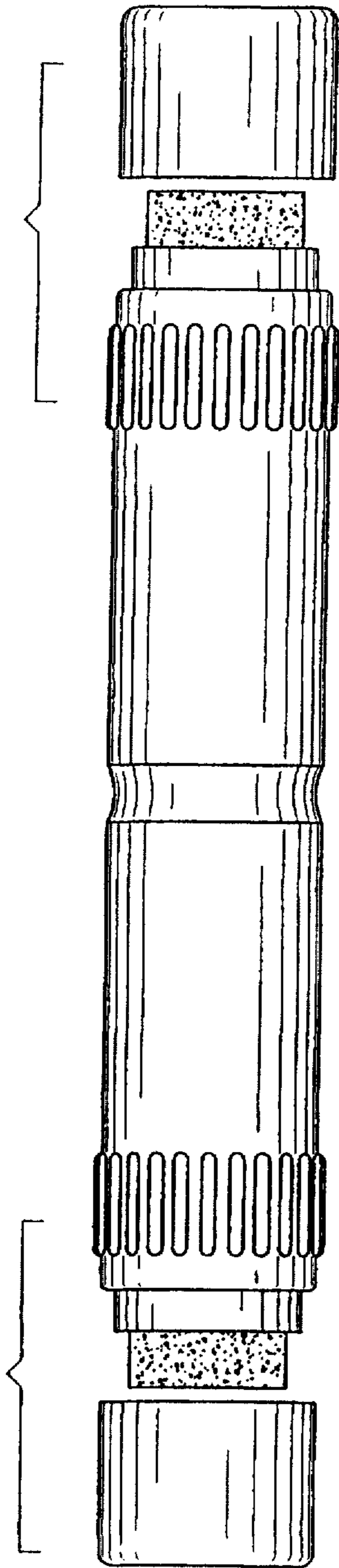
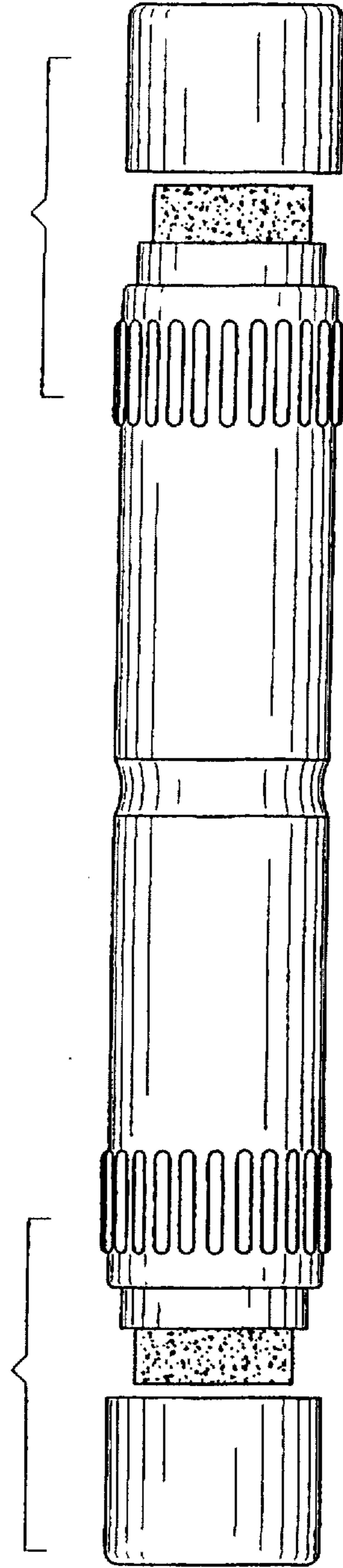
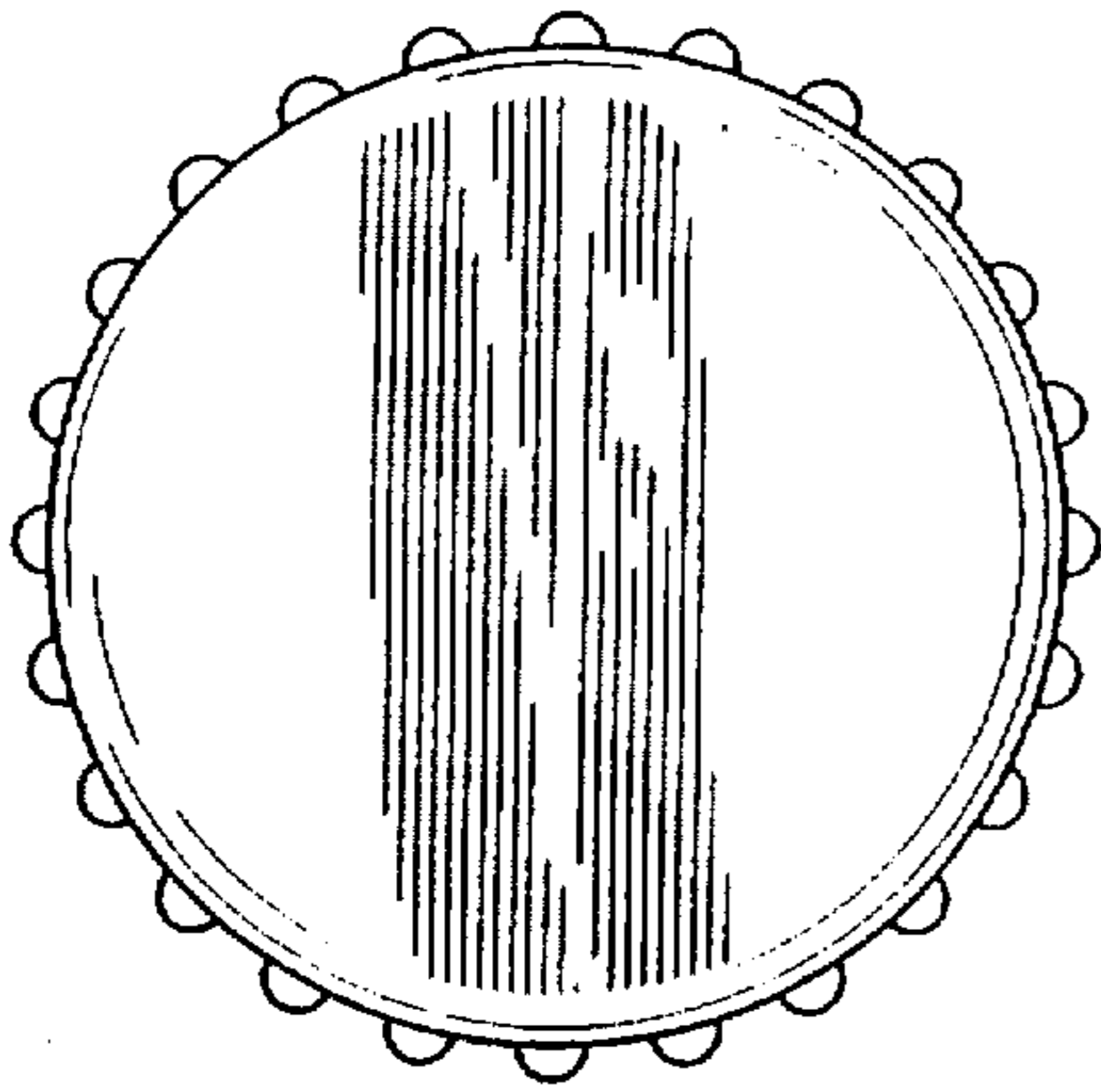

FIG. 2



*FIG. 3*



*FIG. 4*

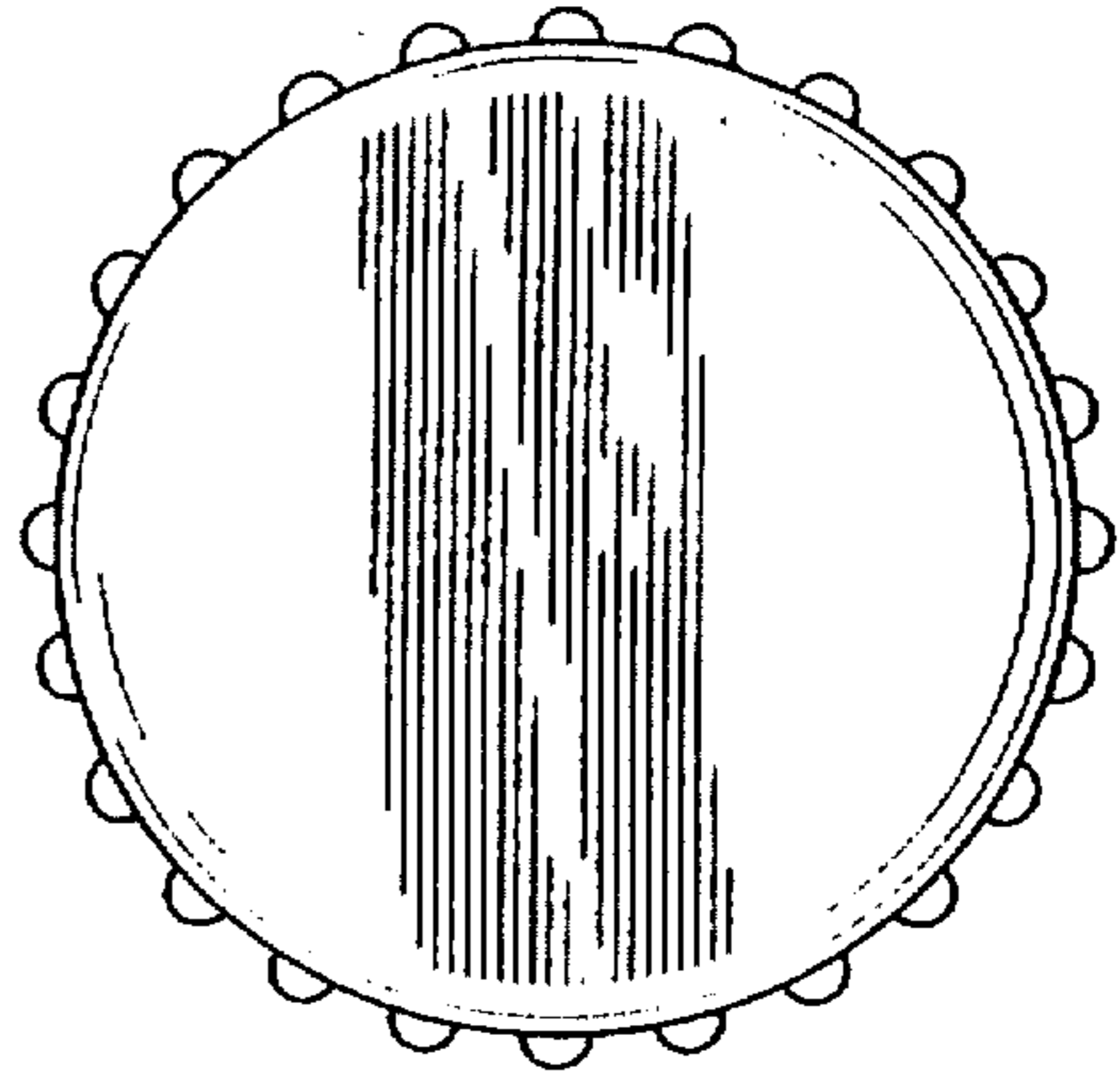



FIG. 5

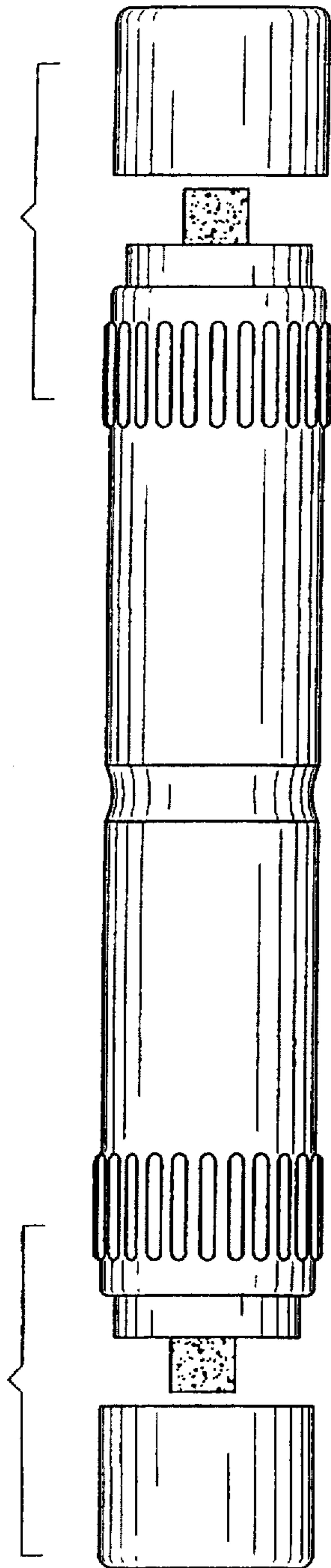

FIG. 6

