



US00D410649S

United States Patent [19] Kobayashi

[11] Patent Number: **Des. 410,649**
[45] Date of Patent: **** Jun. 8, 1999**

[54] **TAPE RECORDER COMBINED WITH DISC PLAYER AND RECEIVER**

[75] Inventor: **Takayuki Kobayashi**, Tokyo, Japan

[73] Assignee: **Sony Corporation**, Tokyo, Japan

[**] Term: **14 Years**

[21] Appl. No.: **29/079,320**

[22] Filed: **Nov. 12, 1997**

[30] **Foreign Application Priority Data**

Jun. 10, 1997 [JP] Japan 9-57207

[51] **LOC (6) Cl.** **14-01**

[52] **U.S. Cl.** **D14/163; D14/168**

[58] **Field of Search** D14/156, 160-165,
D14/167-168, 188, 193-198; 455/344,
347, 350, 351

[56] **References Cited**

U.S. PATENT DOCUMENTS

- D. 329,856 9/1992 Tamaki D14/168
- D. 349,498 8/1994 Fukutome D14/168
- D. 358,593 5/1995 Oba D14/168
- D. 365,733 1/1996 Freedland D14/168 X

OTHER PUBLICATIONS

Portable Audio Catalog, Sony, pp. 234-236 (Feb., 1997).

Primary Examiner—Philip S. Hyder
Assistant Examiner—Nanda Bondade

Attorney, Agent, or Firm—Foley & Lardner

[57] **CLAIM**

The ornamental design for a tape recorder combined with disc player and receiver, as shown and described.

DESCRIPTION

FIG. 1 is a partial perspective view of a tape recorder combined with a disc player and a receiver showing my new design;

FIG. 2 is a top plan view thereof;

FIG. 3 is a left side elevational view thereof, a right side elevational view thereof being a mirror image;

FIG. 4 is a front elevational view thereof;

FIG. 5 is a rear elevational view thereof;

FIG. 6 is a perspective view of a second embodiment of a tape recorder combined with a disc player and a receiver showing my new design;

FIG. 7 is a top plan view thereof;

FIG. 8 is a left side elevational view thereof;

FIG. 9 is a front elevational view thereof;

FIG. 10 is a bottom plan view thereof;

FIG. 11 is a right side elevational view thereof; and,

FIG. 12 is a rear elevational view thereof.

1 Claim, 5 Drawing Sheets

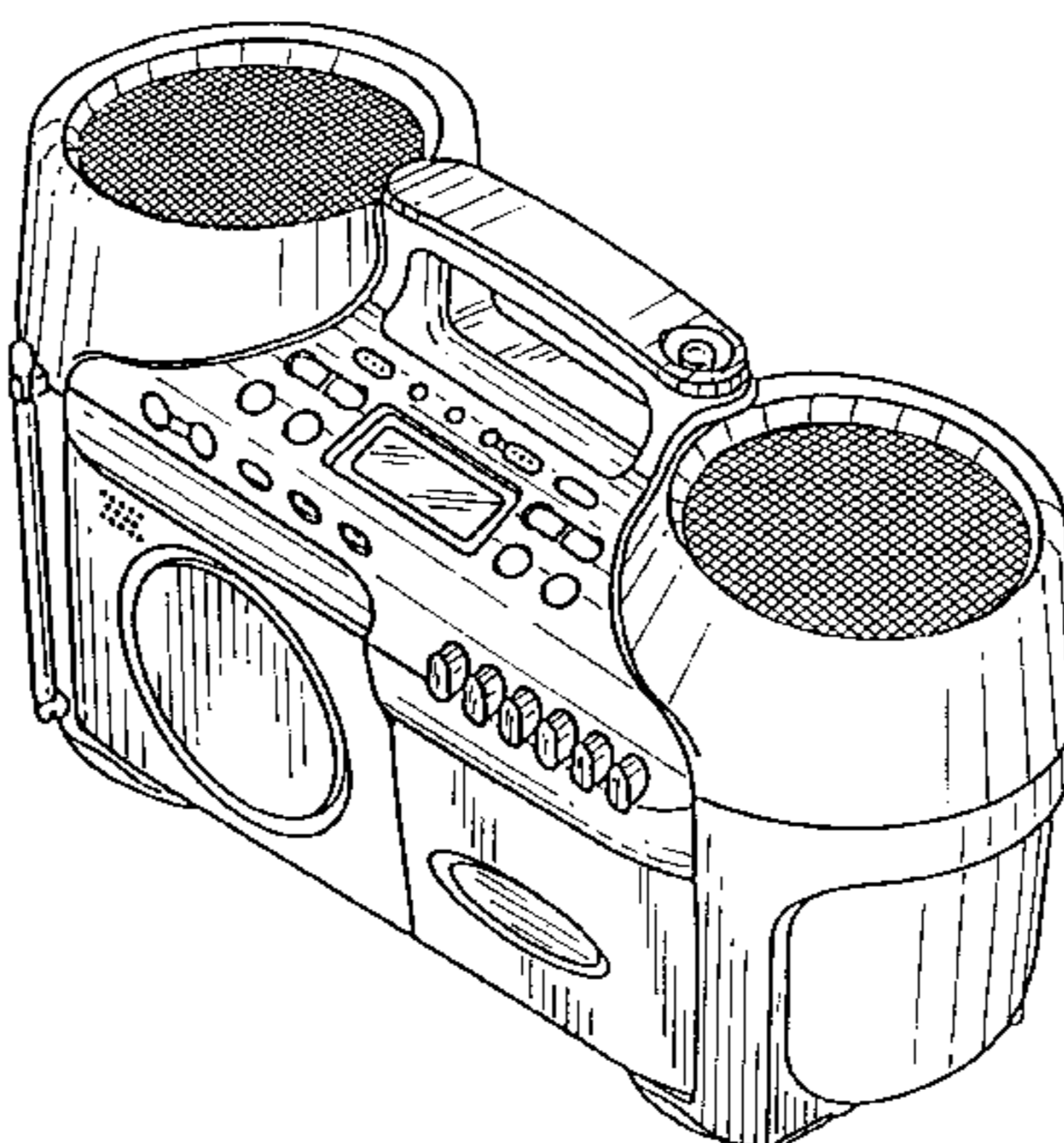
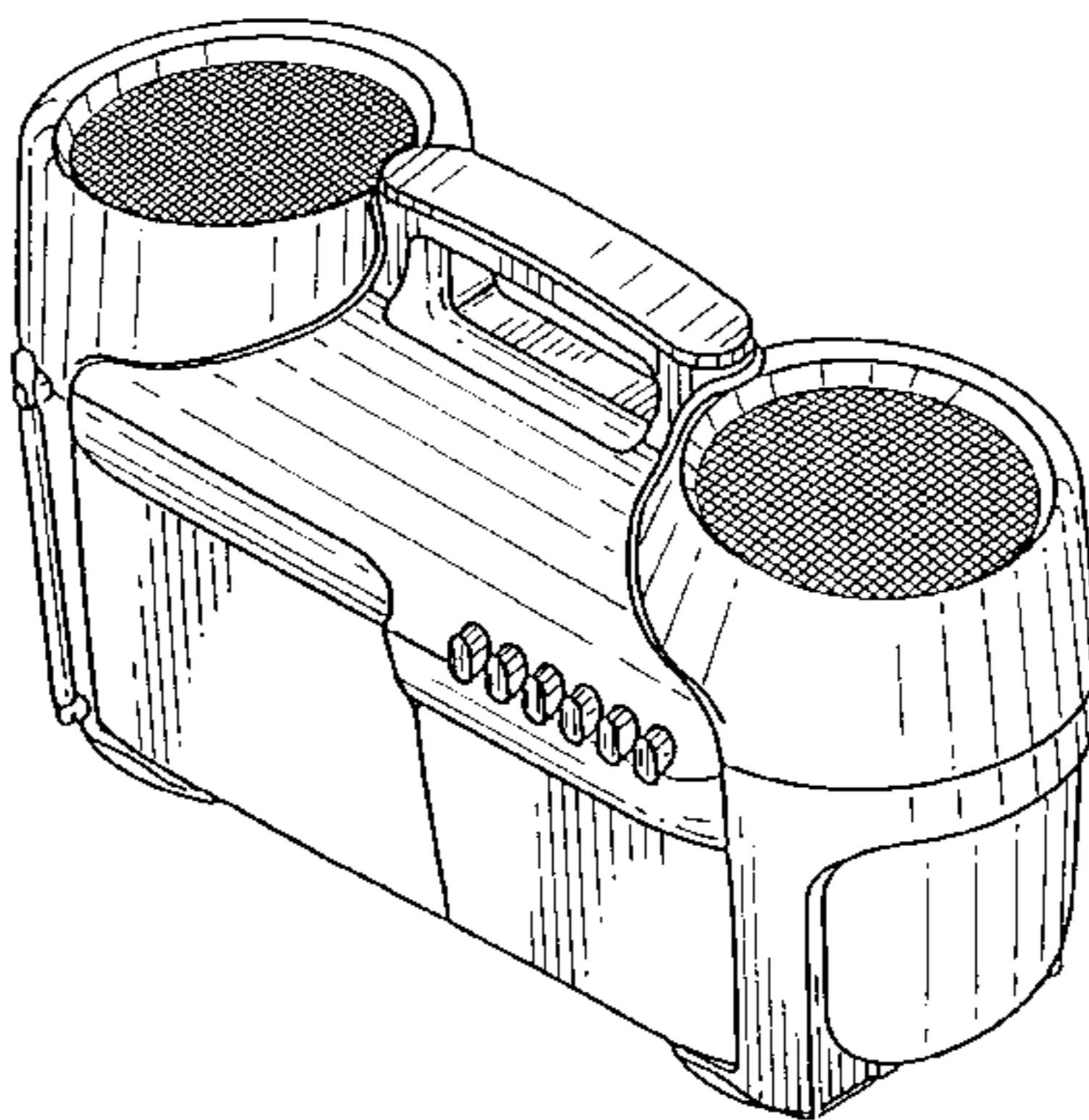

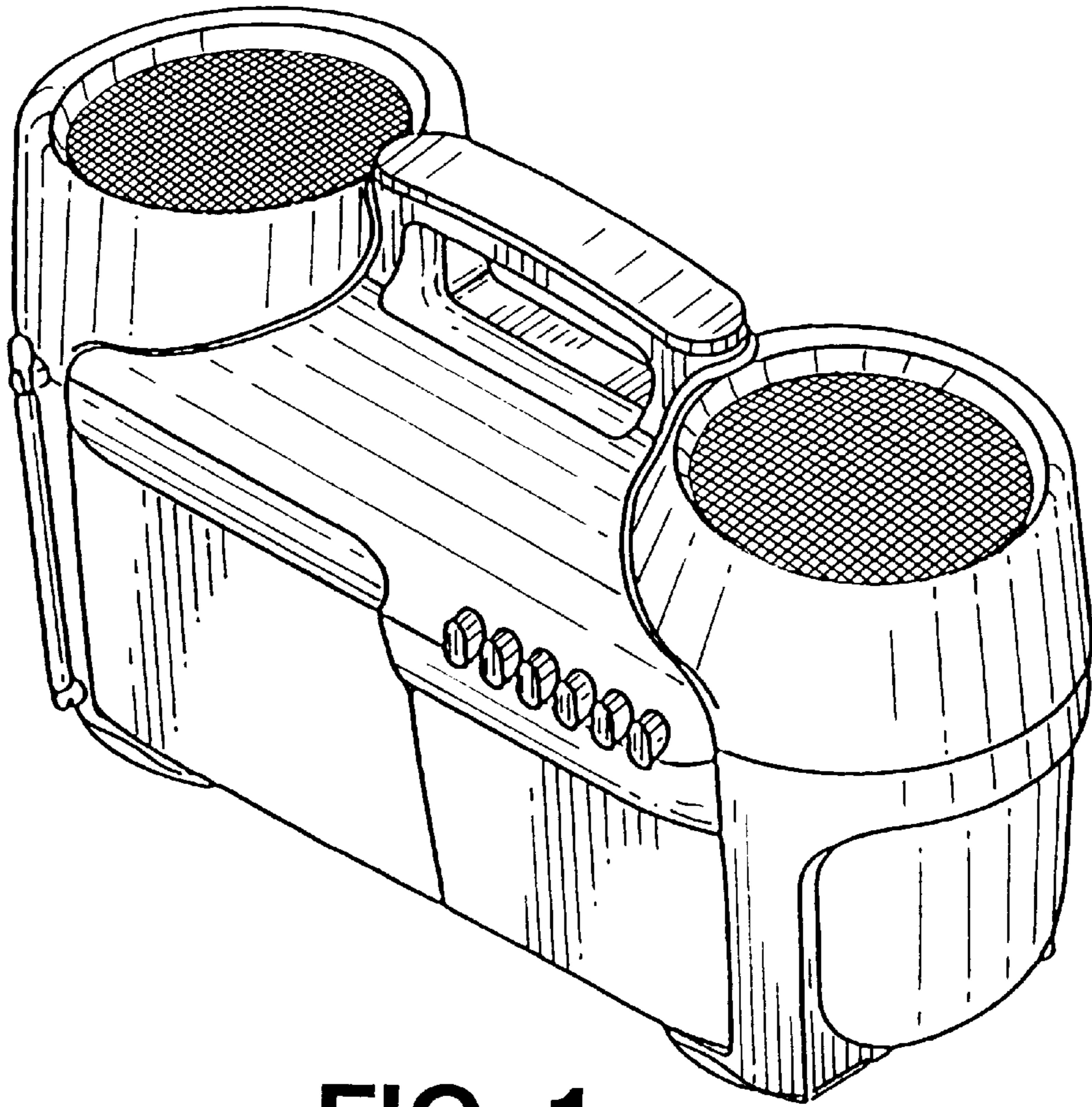

FIG. 1

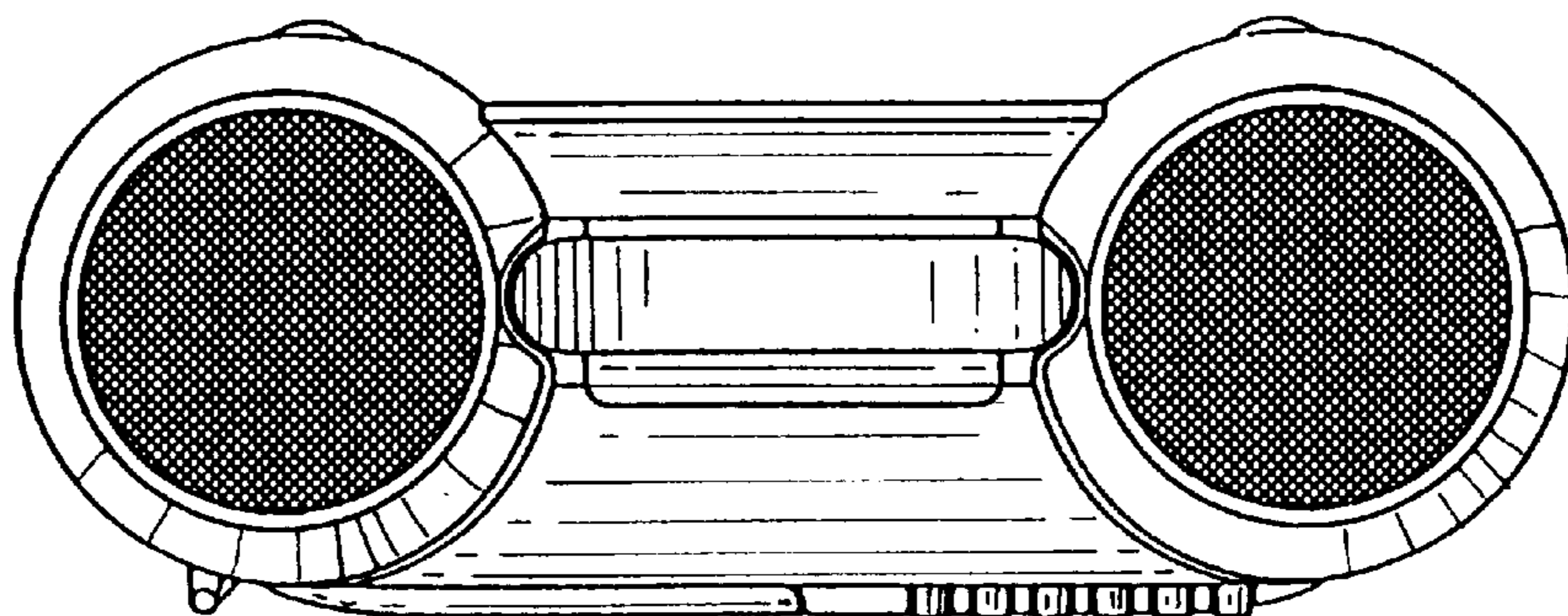

FIG. 2

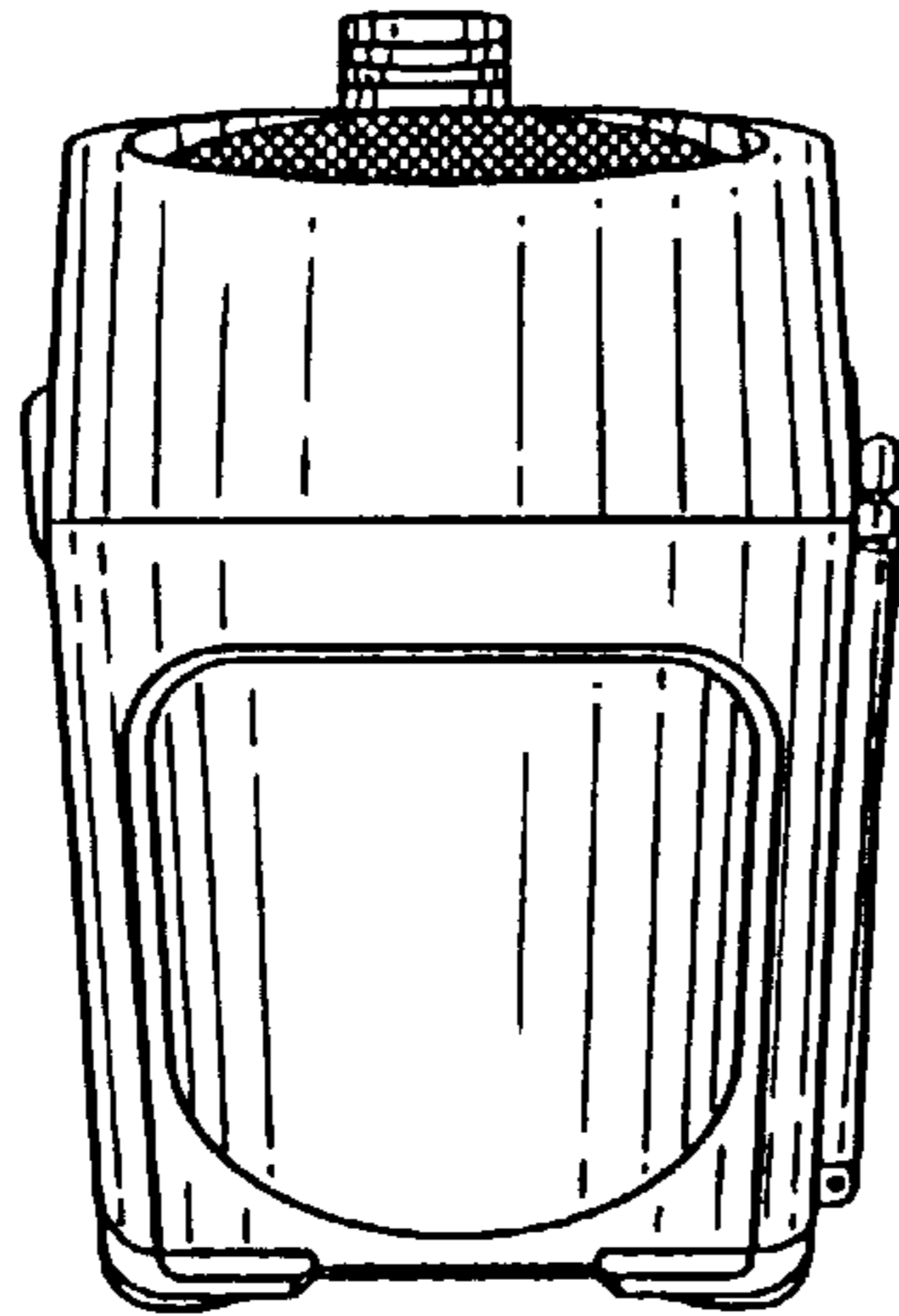

FIG. 3

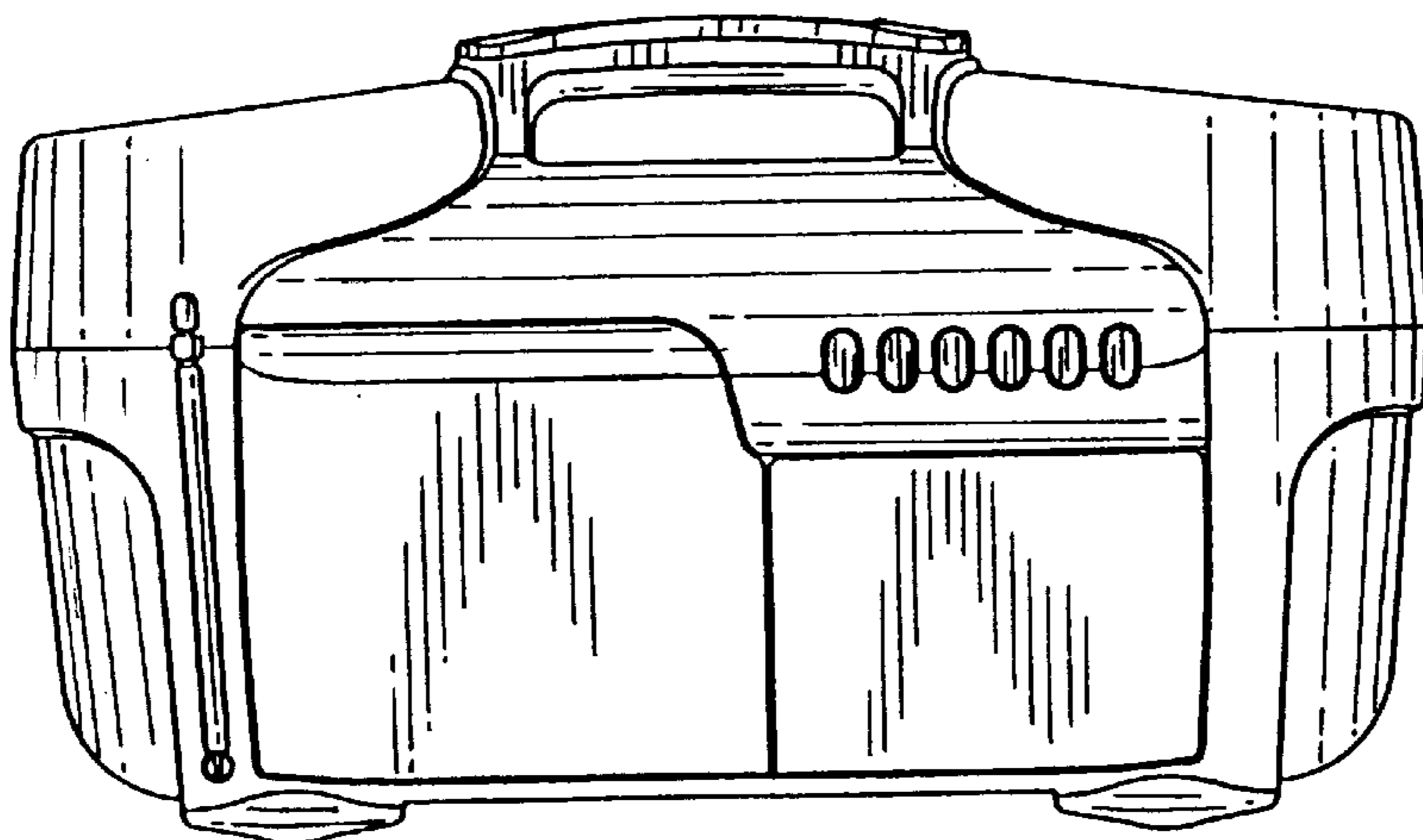

FIG. 4

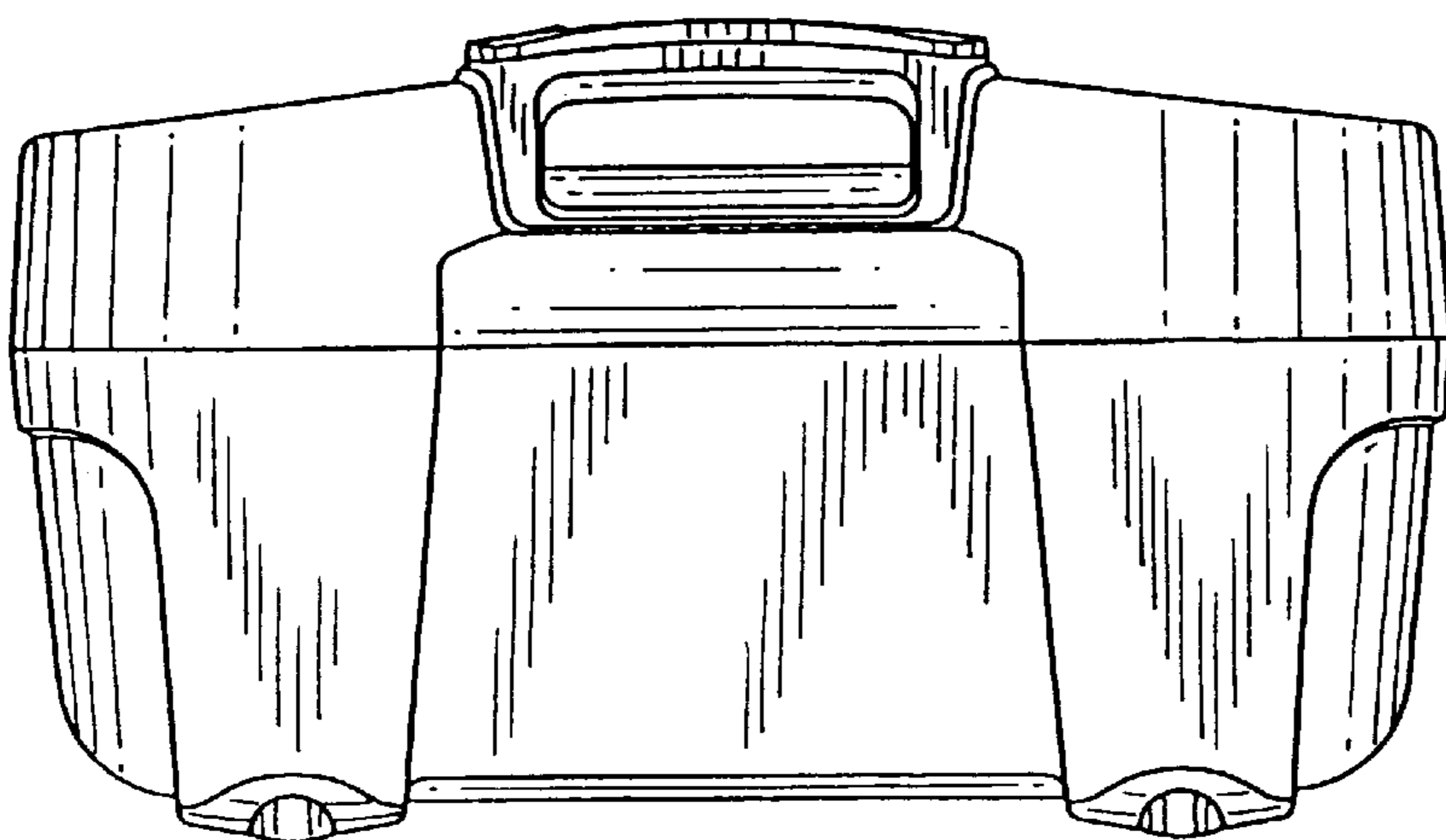

FIG. 5

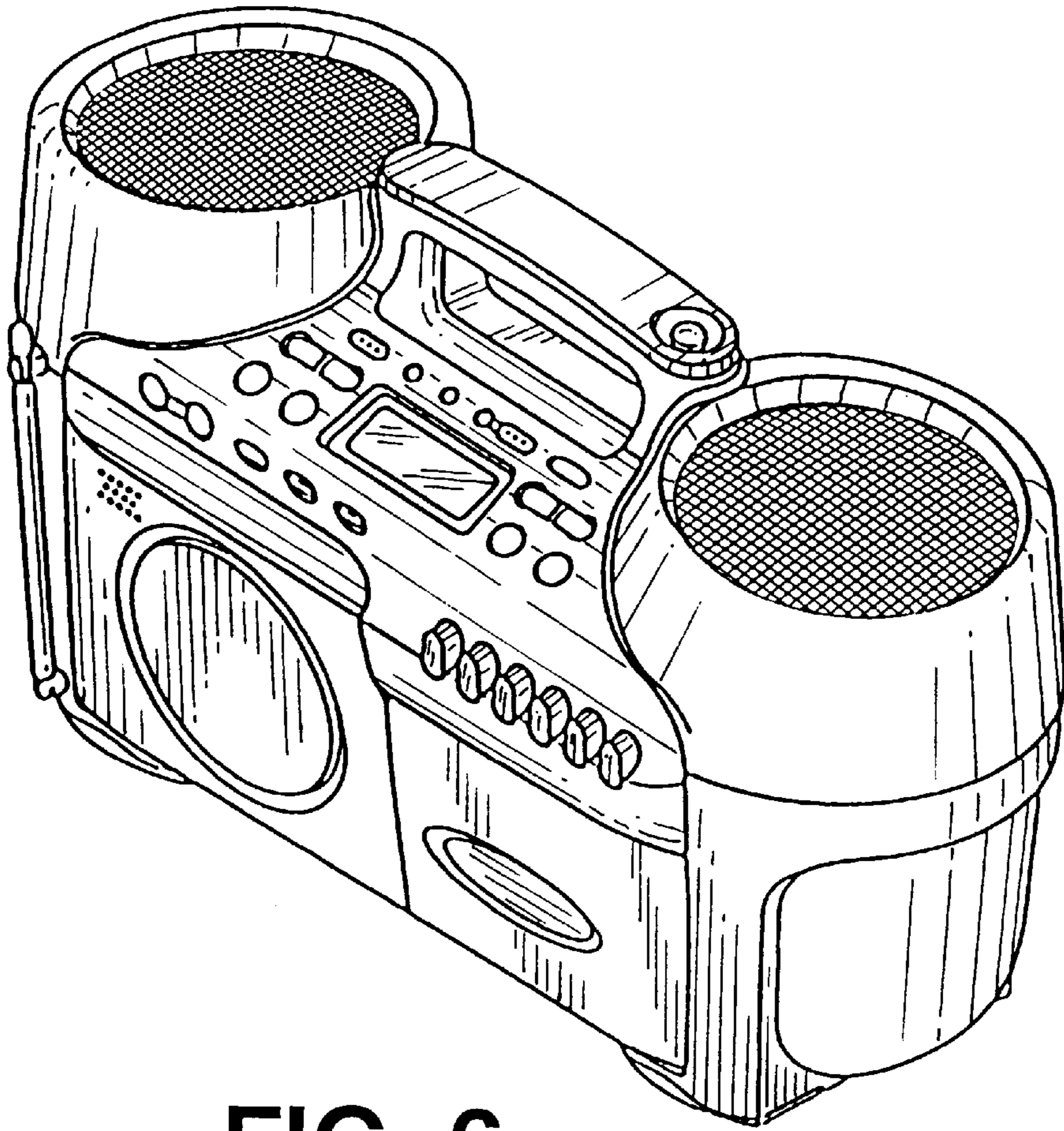

FIG. 6

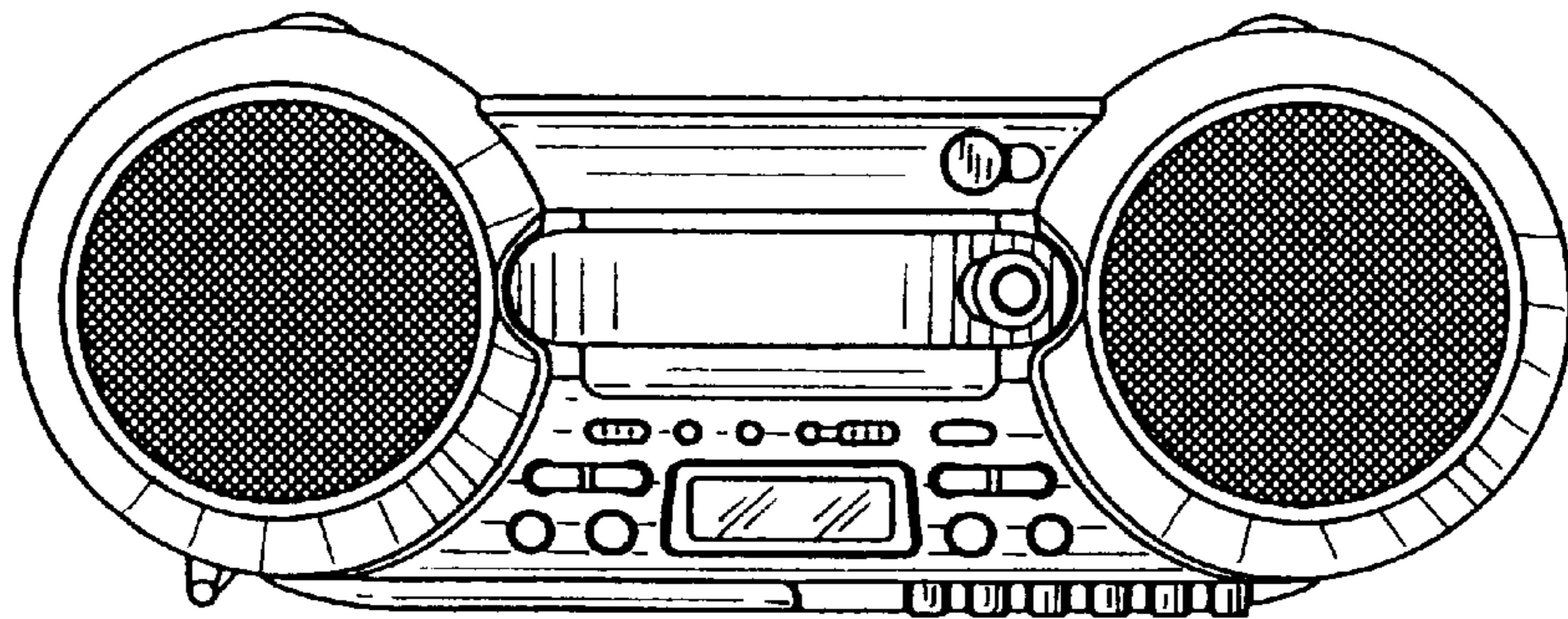

FIG. 7

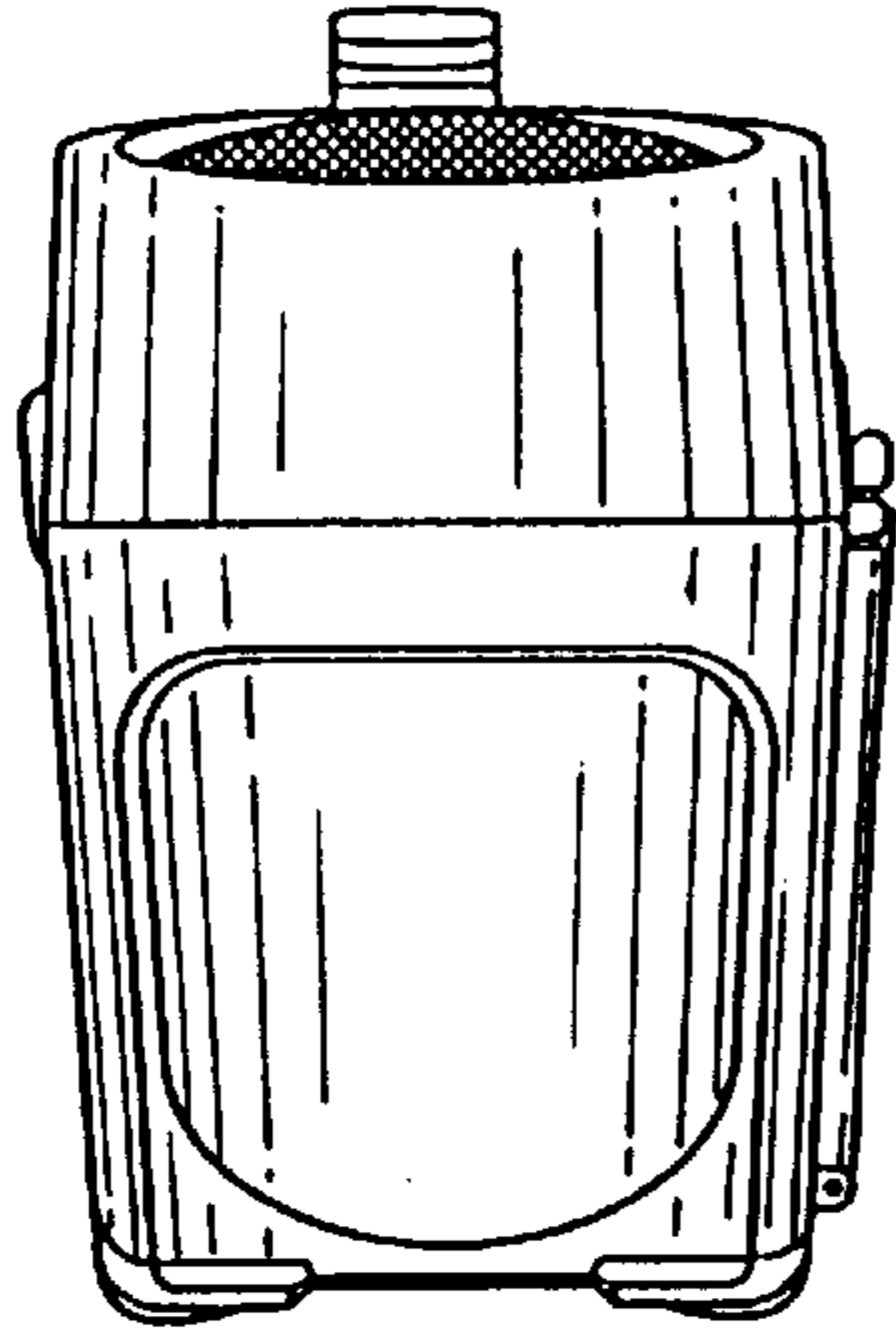

FIG. 8

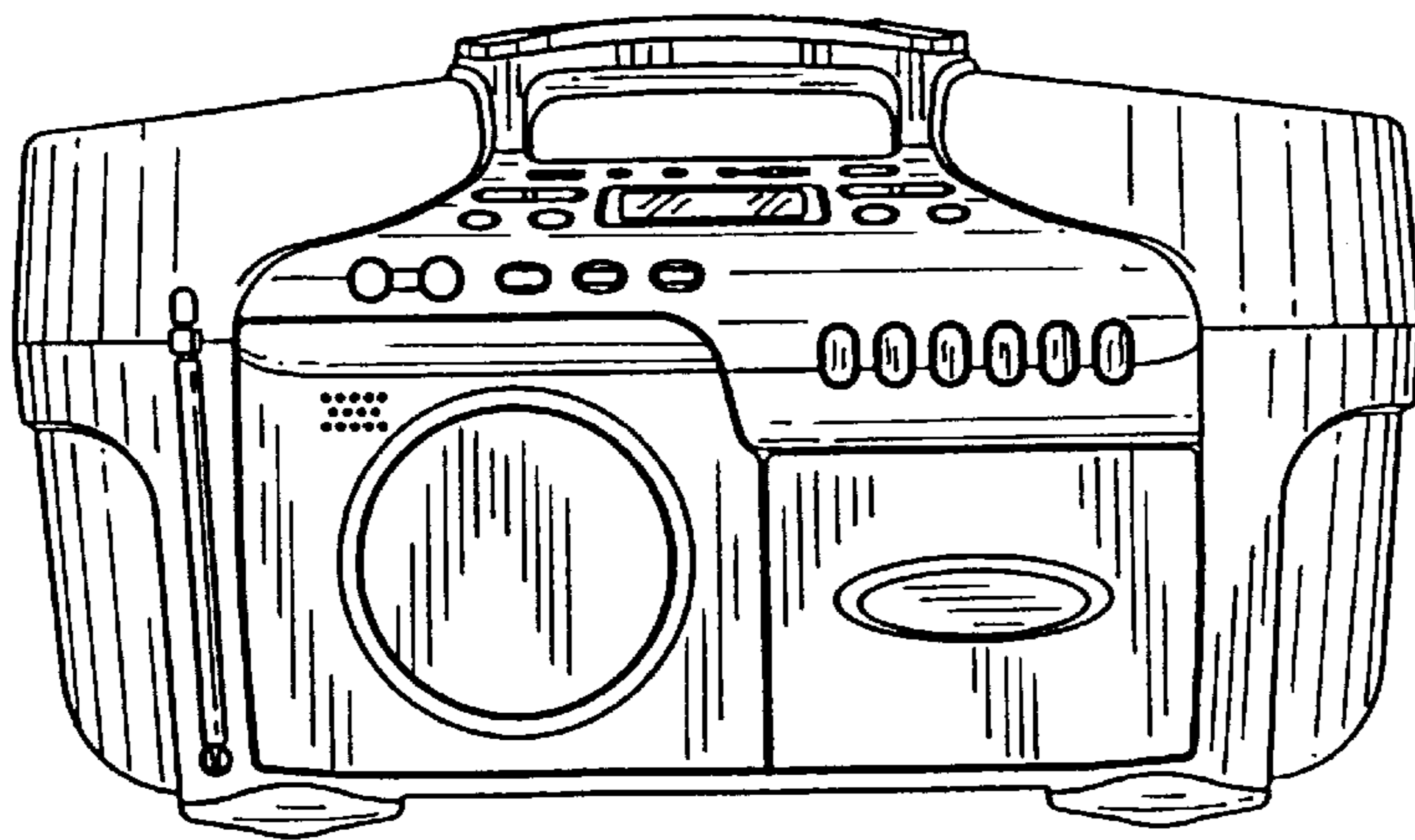

FIG. 9

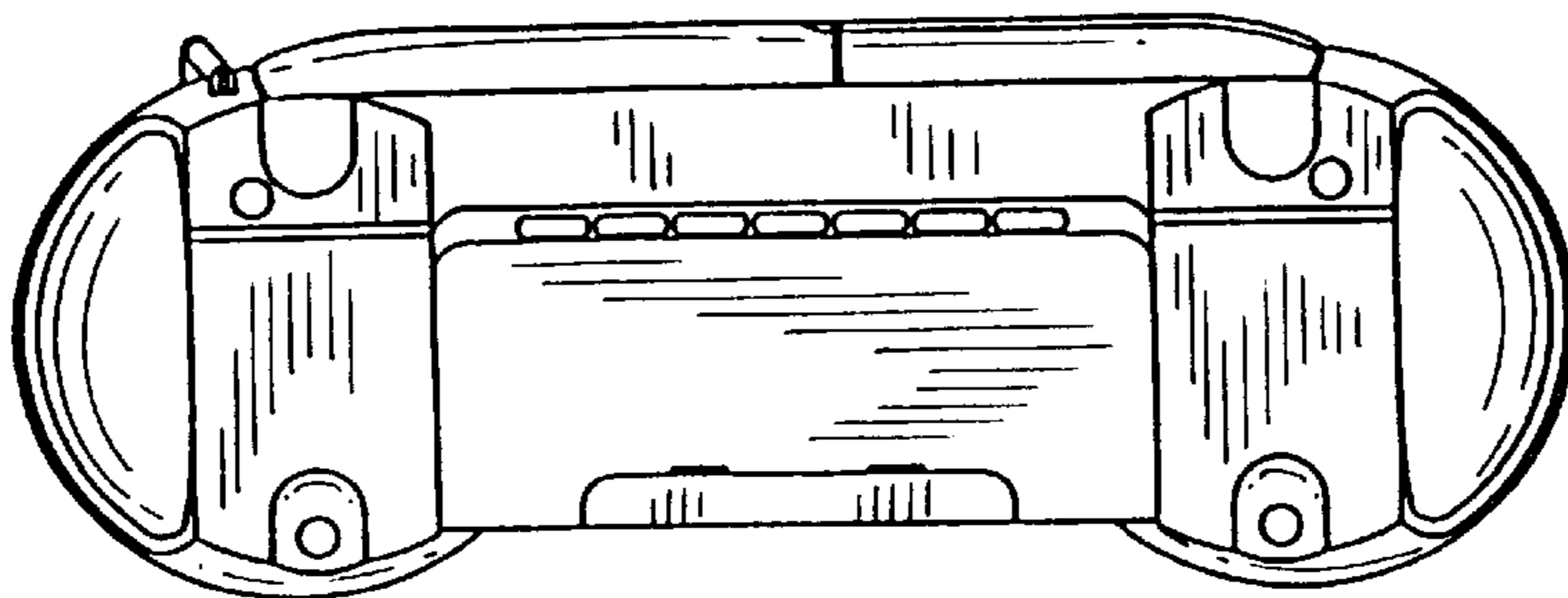

FIG. 10

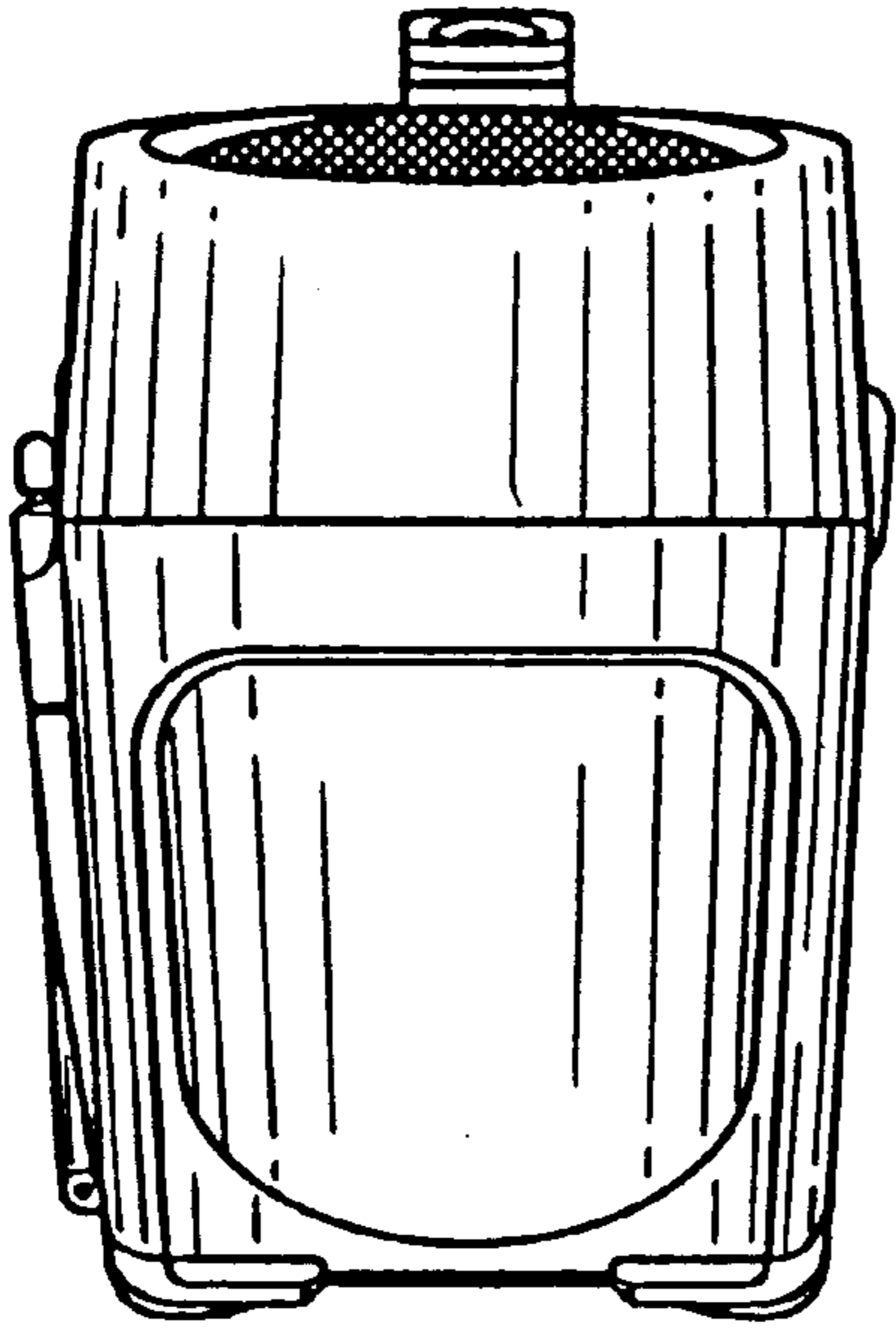

FIG. 11

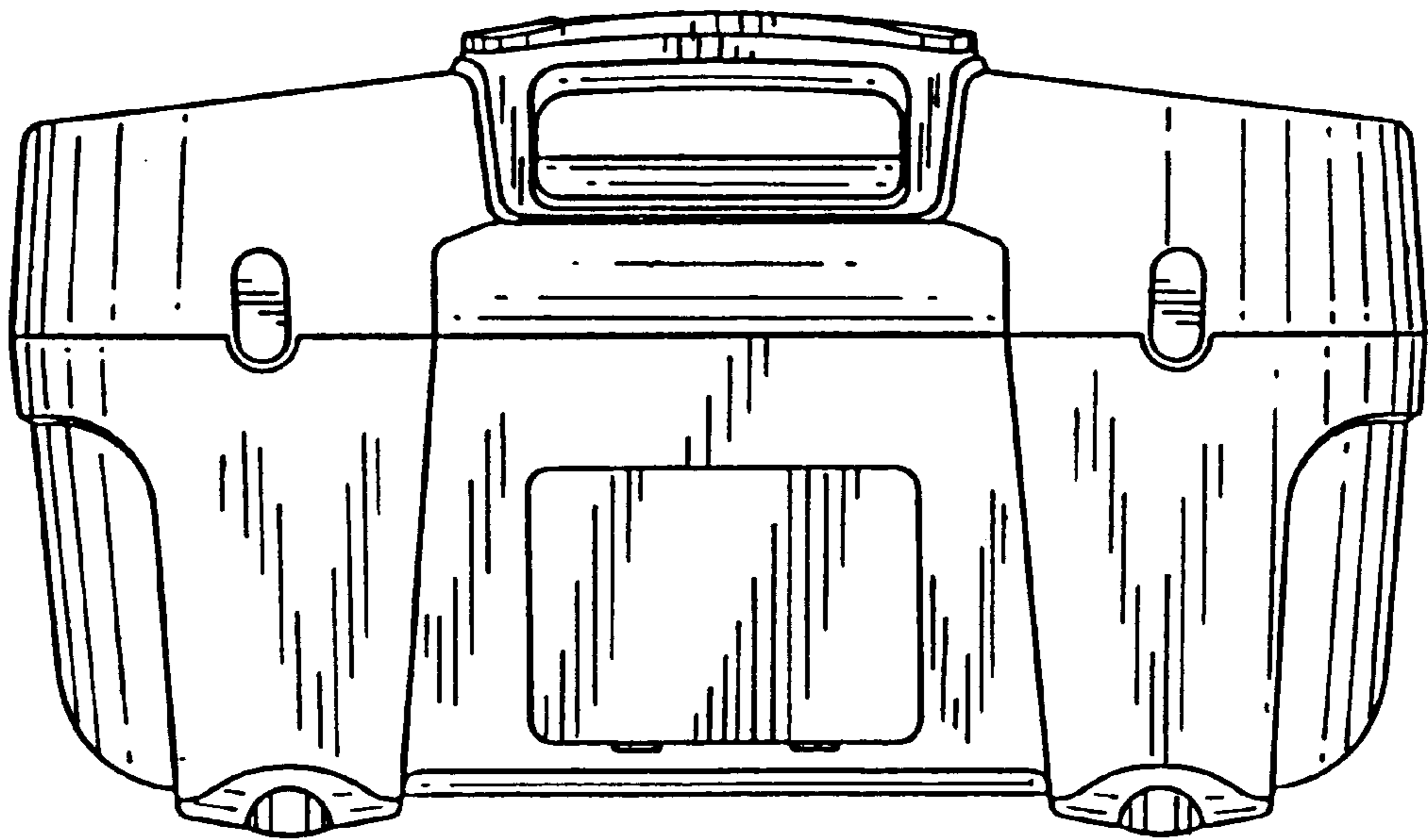

FIG. 12