



US00D410633S

**United States Patent** [19]  
**Tsui**

[11] **Patent Number: Des. 410,633**  
[45] **Date of Patent: \*\* Jun. 8, 1999**

[54] **REMOTE CONTROL UNIT**

[76] Inventor: **Philip Y. W. Tsui**, 3513 Ingram Road,  
Mississauga, Ontario, Canada, 15L 4M4

[\*\*] Term: **14 Years**

[21] Appl. No.: **29/073,967**

[22] Filed: **Jul. 24, 1997**

**Related U.S. Application Data**

[62] Division of application No. 29/064,997, Jan. 16, 1997.

[51] **LOC (6) Cl.** ..... **13-03**

[52] **U.S. Cl.** ..... **D13/168; D18/7**

[58] **Field of Search** ..... D13/158, 168;  
D10/104, 106; D14/191, 218; D18/7; D21/48,  
111, 141.1; 70/256, 257; 123/179.2; 340/825.31,  
825.57, 825.69, 825.72; 341/176; 348/734;  
359/142; 362/109

[56] **References Cited**

**U.S. PATENT DOCUMENTS**

D. 303,521	9/1989	Savio et al.	.....	D18/7	X
D. 306,857	3/1990	Beaumont	.....	D14/218	X
D. 313,243	12/1990	Chimalamarri	.....	D18/7	
D. 317,754	6/1991	Accumanno	.....	D13/158	X
D. 336,260	6/1993	Jensen	.....	D10/106	

**OTHER PUBLICATIONS**

“Video Review”, Phillips Combi Player, Remote, p. 84, Jul. 1989.

*Primary Examiner*—James Gandy

*Assistant Examiner*—Cathron B. Matta  
*Attorney, Agent, or Firm*—Blakely, Sokoloff, Taylor & Zafman

[57] **CLAIM**

The ornamental design for a remote control unit, as shown.

**DESCRIPTION**

FIG. 1 is a front right top perspective view of a remote control unit.

FIG. 2 is a rear left bottom perspective view of the remote control unit shown in FIG. 1;

FIG. 3 is a top plan view of the remote control unit shown in FIG. 1;

FIG. 4 is a front elevational view of the remote control unit shown in FIG. 1;

FIG. 5 is a bottom plan view of the the remote control unit shown in FIG. 1;

FIG. 6 is a rear elevational view of the remote control unit shown in FIG. 1;

FIG. 7 is a right side view of the remote control unit shown in FIG. 1; and,

FIG. 8 is a left side view of the remote control unit shown in FIG. 1.

**1 Claim, 3 Drawing Sheets**

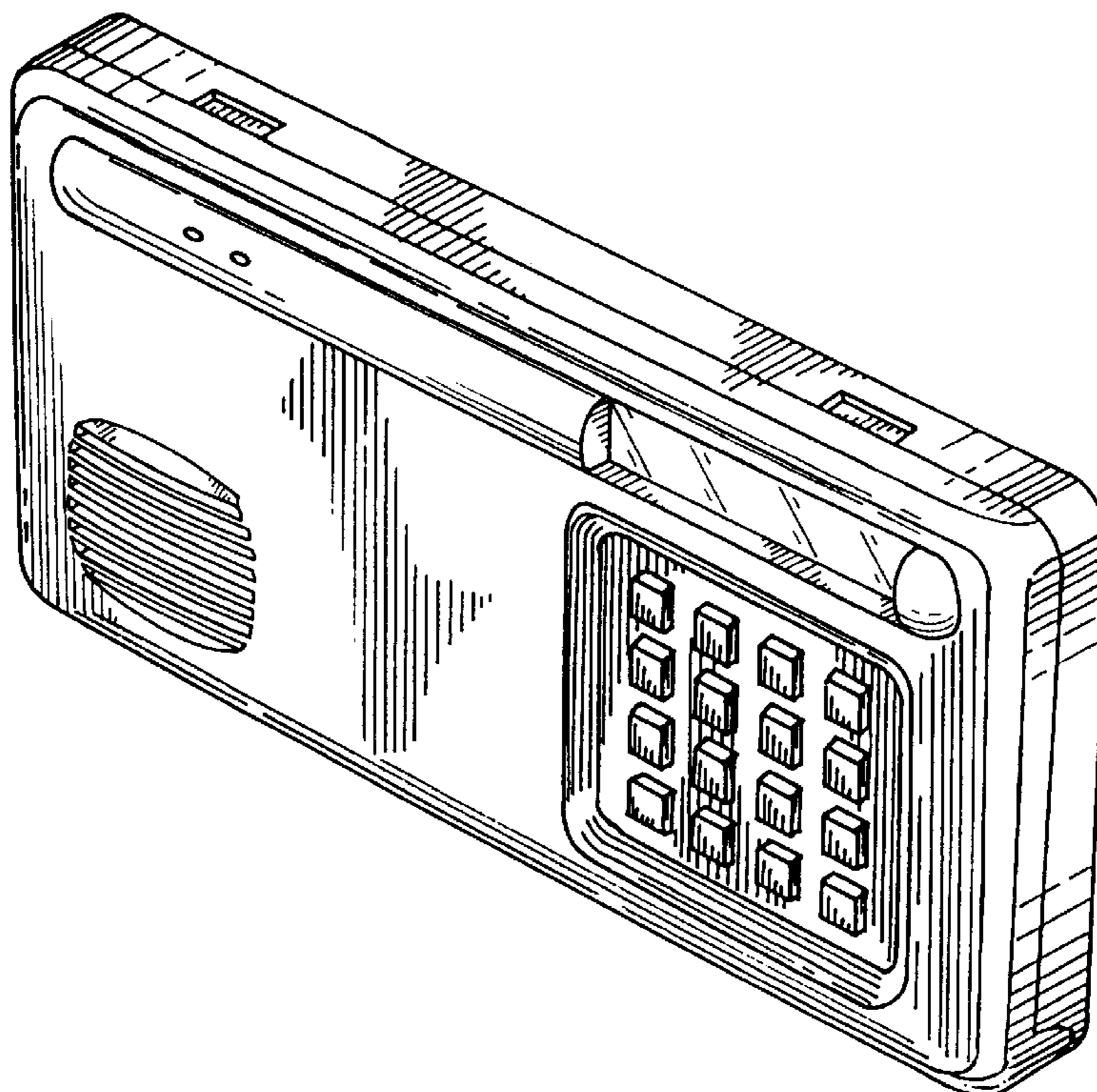

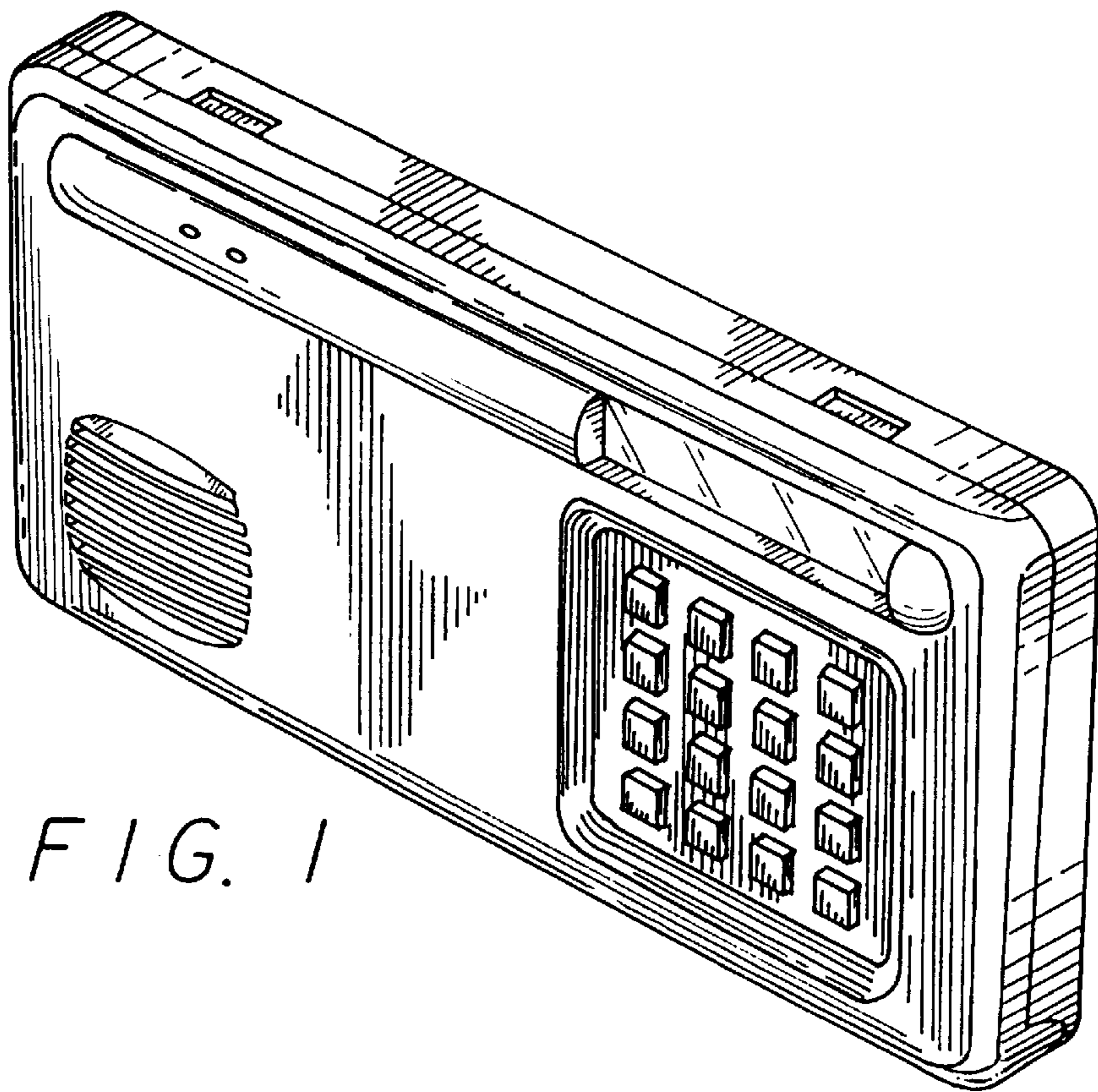

FIG. 1

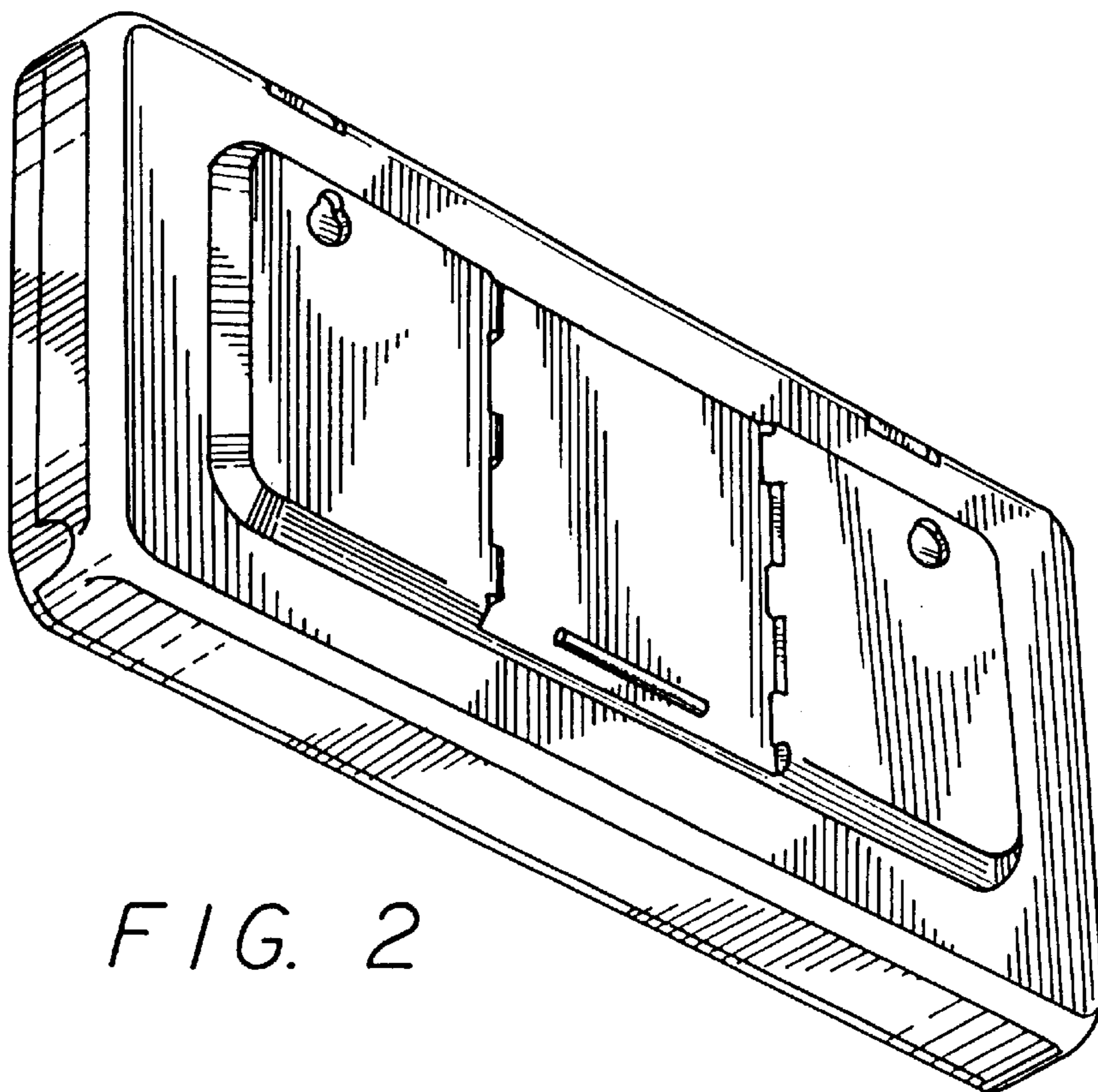

FIG. 2

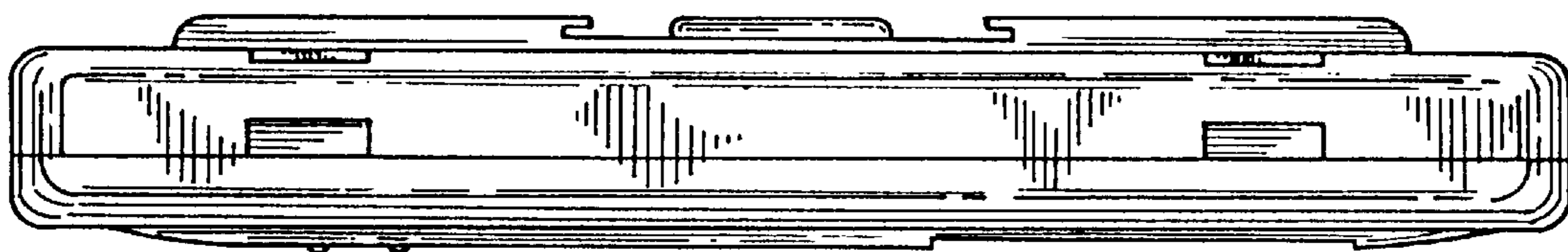

FIG. 3

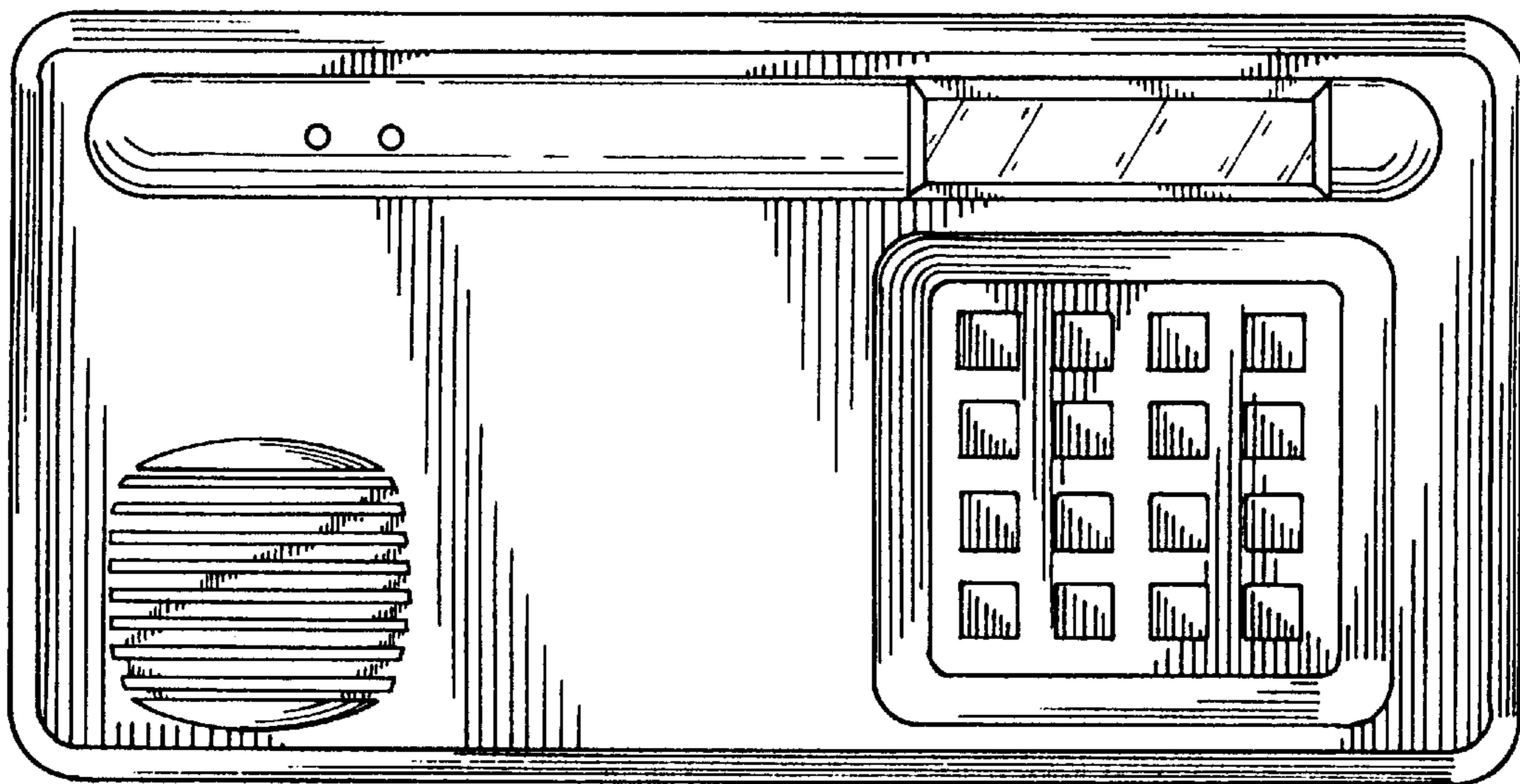

FIG. 4

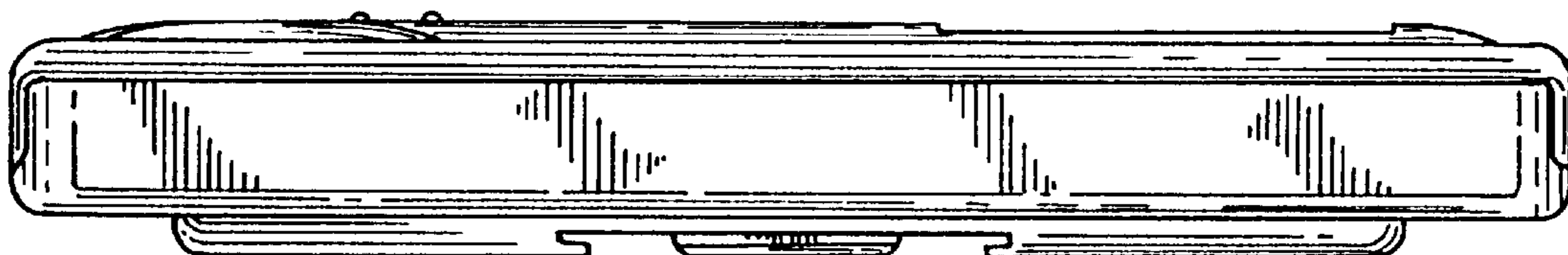

FIG. 5



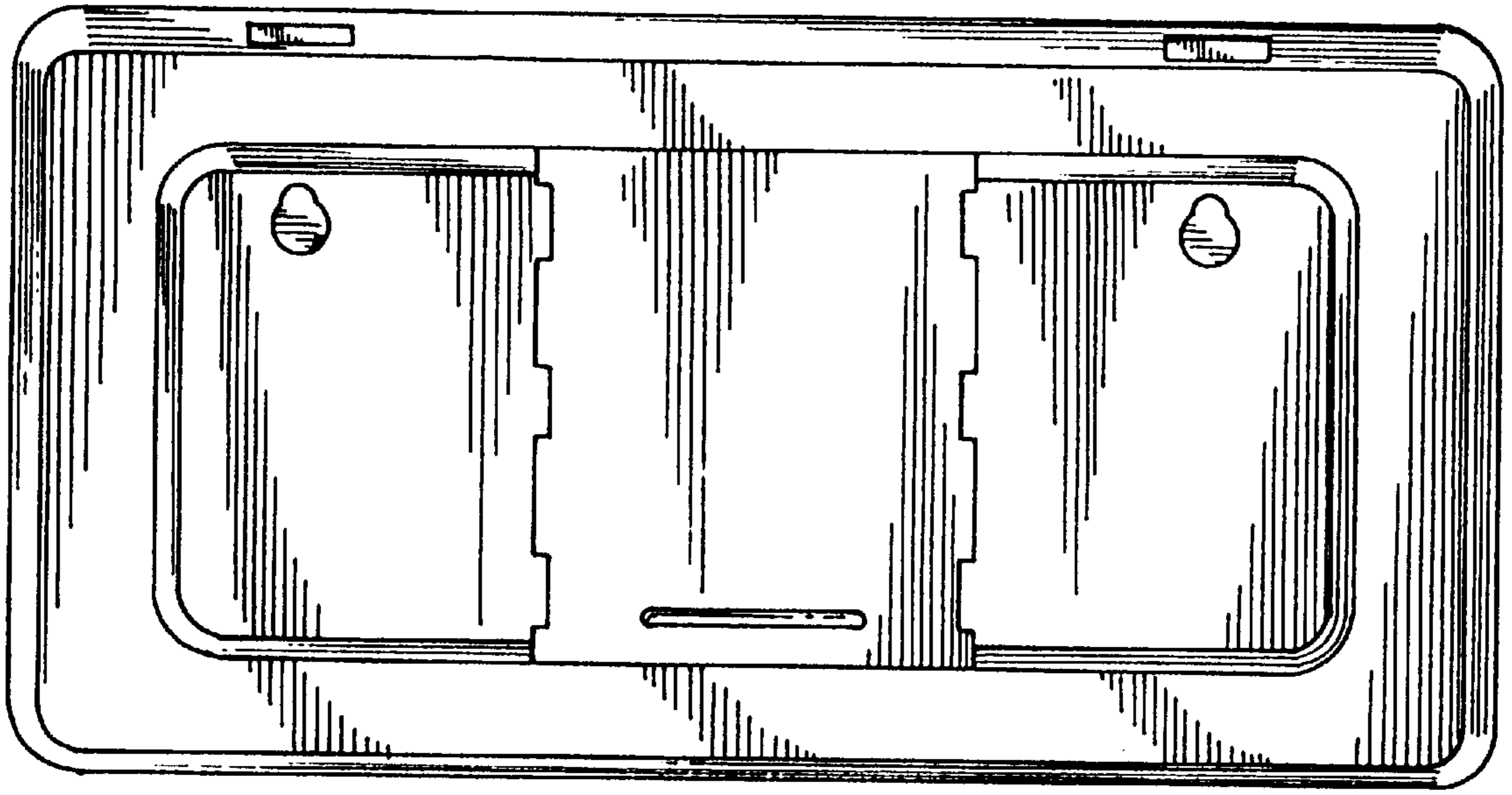

FIG. 6

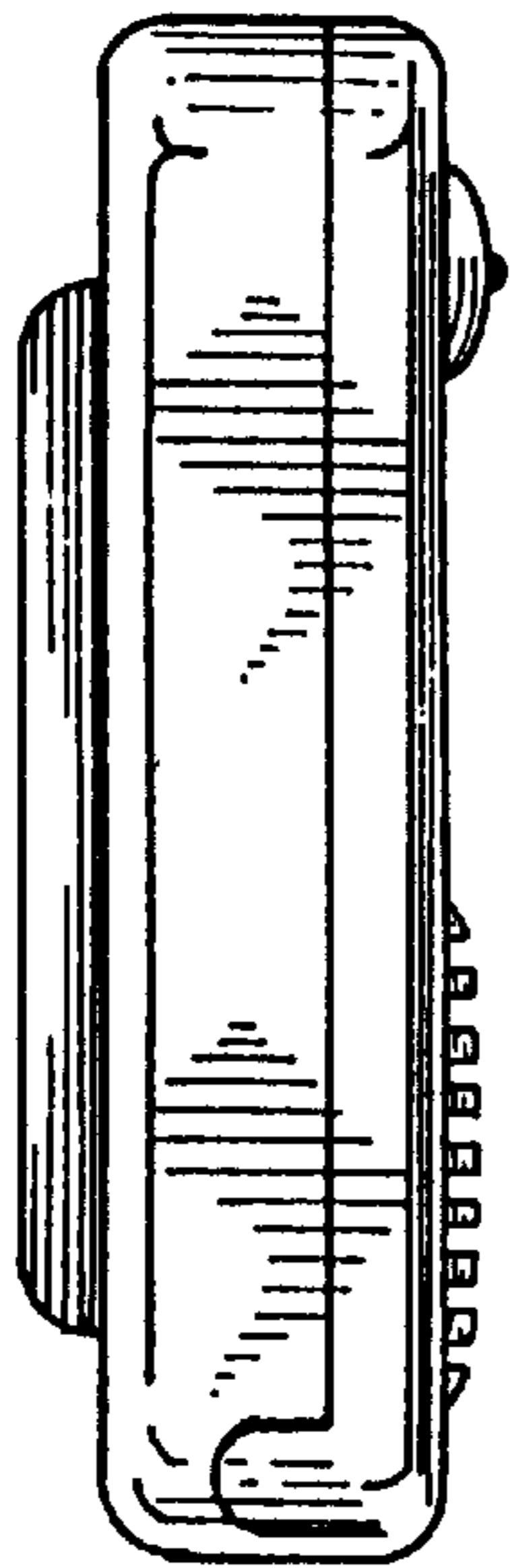

FIG. 7

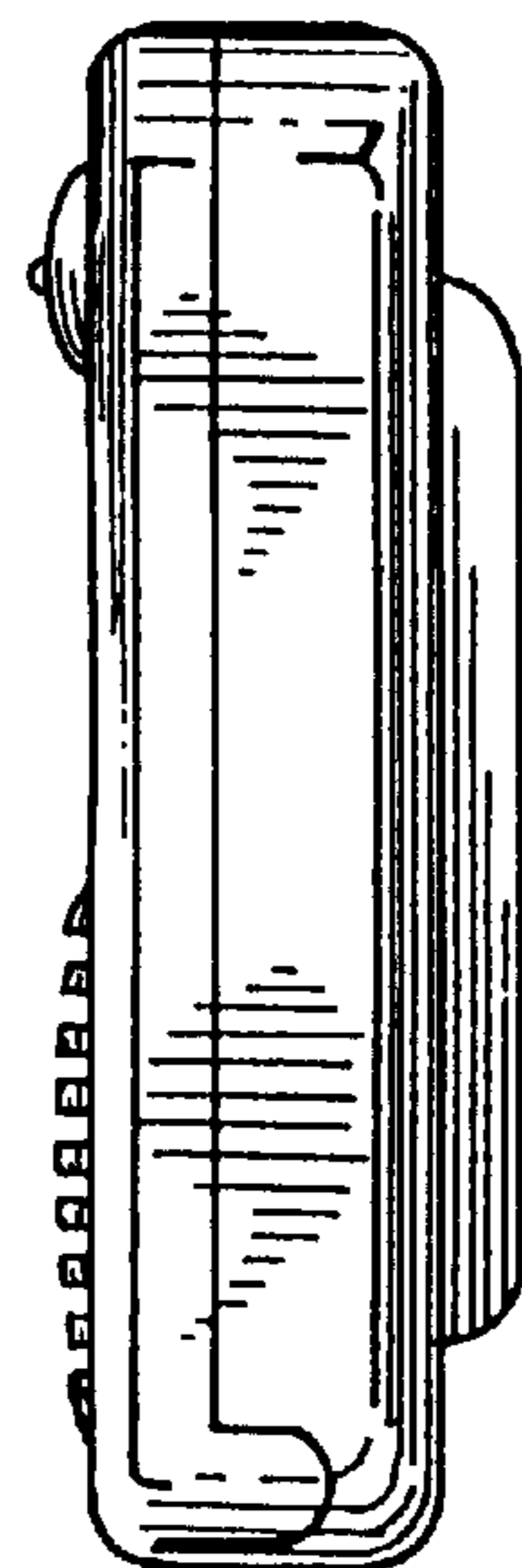

FIG. 8