



US00D410623S

United States Patent [19]
Kolinen

[11] **Patent Number: Des. 410,623**
[45] **Date of Patent: ** Jun. 8, 1999**

[54] **BATTERY**

[75] Inventor: **Petteri Kolinen**, Helsinki, Finland

[73] Assignee: **Nokia Mobile Phones Limited**, Espoo, Finland

[**] Term: **14 Years**

[21] Appl. No.: **29/081,755**

[22] Filed: **Jan. 9, 1998**

[30] **Foreign Application Priority Data**

Jul. 18, 1997 [FI] Finland 538/97

[51] **LOC (6) Cl.** **13-02**

[52] **U.S. Cl.** **D13/103**

[58] **Field of Search** D13/103; 429/96-100,
429/163, 176

[56] **References Cited**

U.S. PATENT DOCUMENTS

D. 321,183	10/1991	Powell et al.	D14/138
D. 328,733	8/1992	Seymour	D13/103
D. 331,566	12/1992	Seymour	D13/103
D. 346,580	5/1994	Tattari	D13/103
D. 346,581	5/1994	Tattari	D13/103
D. 349,882	8/1994	Johnson	D13/103

D. 350,110	8/1994	Johnson	D13/103
D. 357,896	5/1995	Berry	D13/103
D. 358,127	5/1995	Berry	D13/103
D. 358,128	5/1995	Berry et al.	D13/103
D. 359,267	6/1995	Berry et al.	D13/103
D. 361,309	8/1995	White	D13/103
D. 366,452	1/1996	Lindahl	D13/103
D. 380,728	7/1997	Richards et al.	D13/103
D. 389,117	1/1998	Nuovo et al.	D13/103
D. 395,277	6/1998	Finke-Anlauff	D13/103

Primary Examiner—Joel Sincavage
Attorney, Agent, or Firm—Perman & Green, LLP

[57] **CLAIM**

The ornamental design of a “battery”, as shown and described.

DESCRIPTION

FIG. 1 is a bottom plan view showing my new design;
FIG. 2 is a right side elevational view thereof;
FIG. 3 is a rear elevational view thereof;
FIG. 4 is a left side elevational view thereof;
FIG. 5 is a top plan view thereof;
FIG. 6 is a front elevational view thereof;
FIG. 7 is a rear, left side and top perspective view thereof;
and,
FIG. 8 is a front, right side and bottom perspective view.

1 Claim, 3 Drawing Sheets

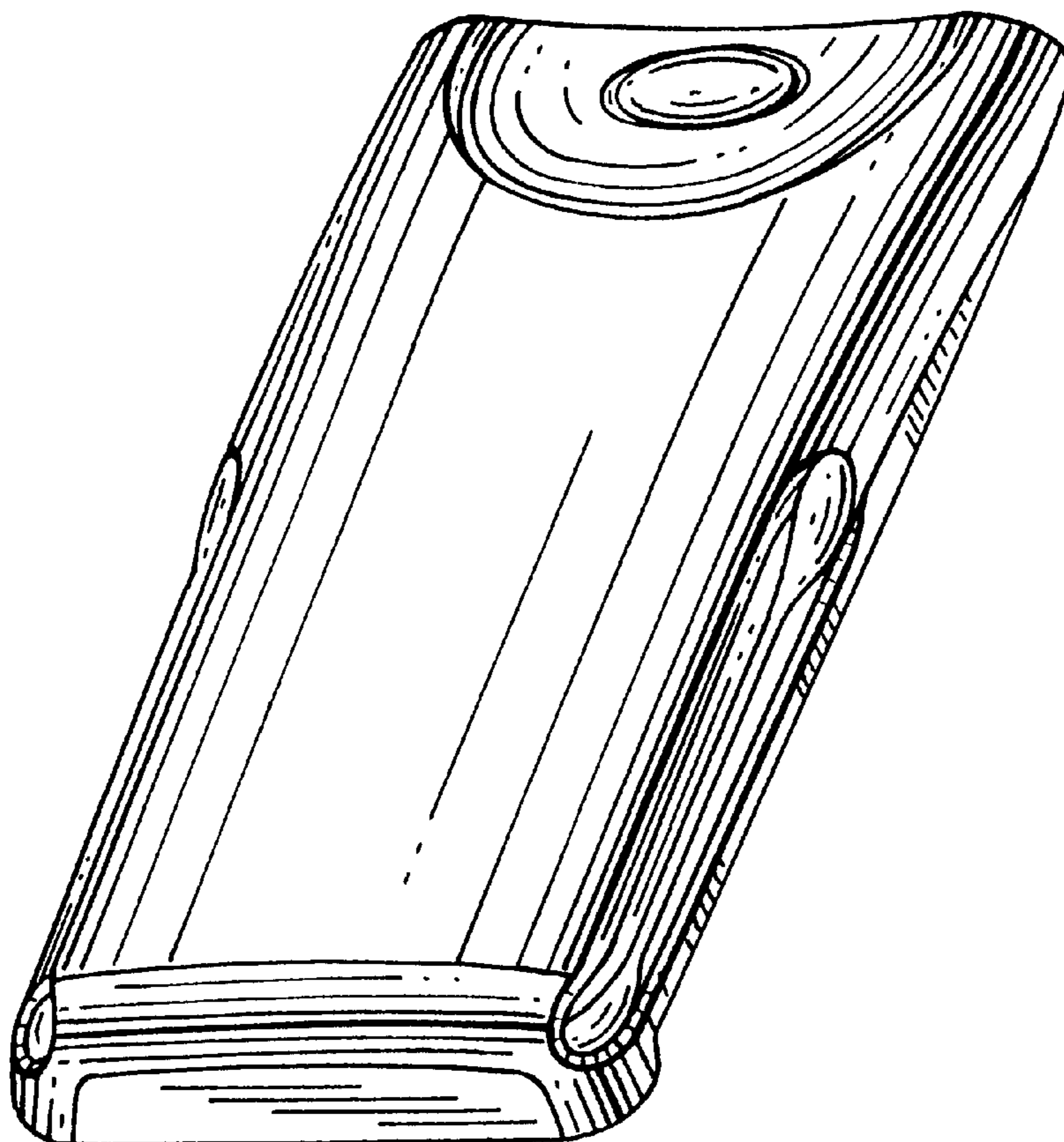

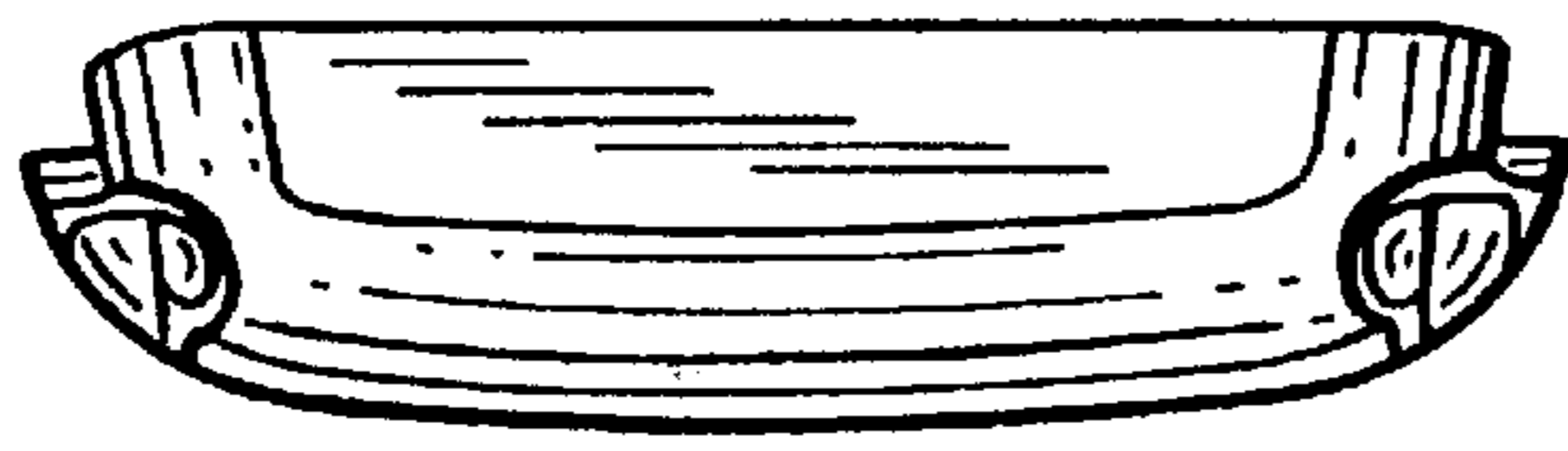

FIG. 1



FIG. 2

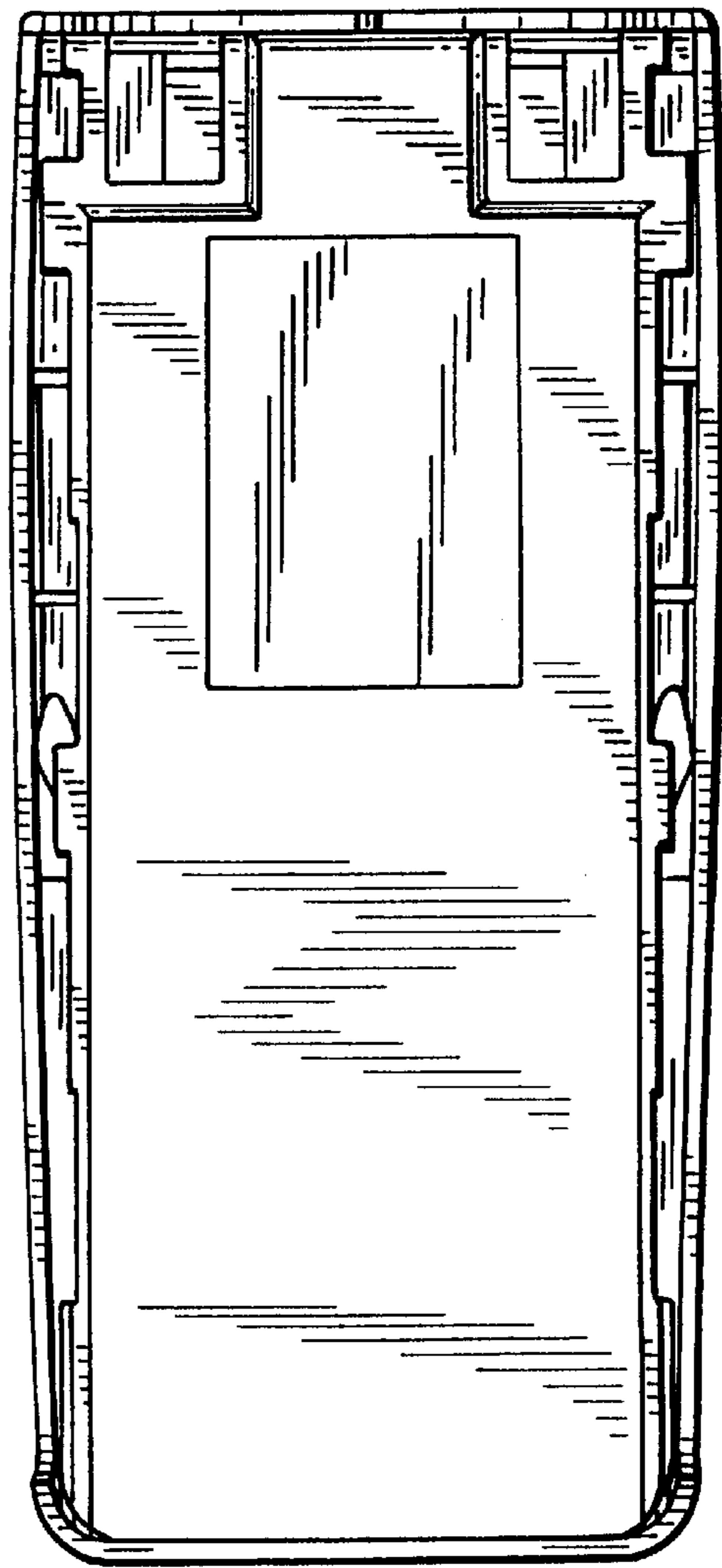

FIG. 3

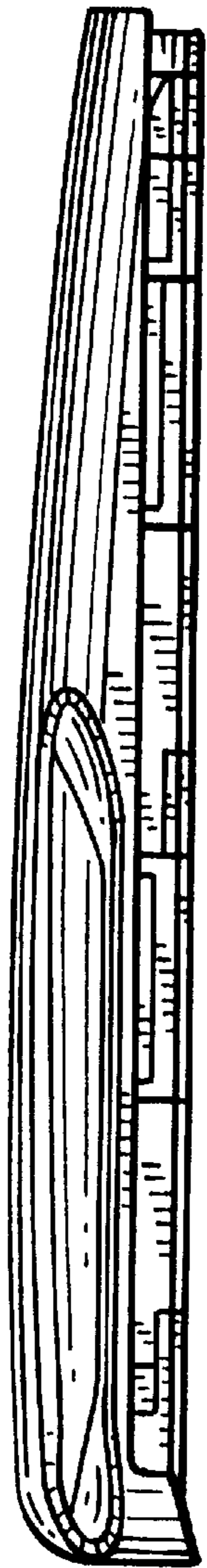

FIG. 4

FIG. 5

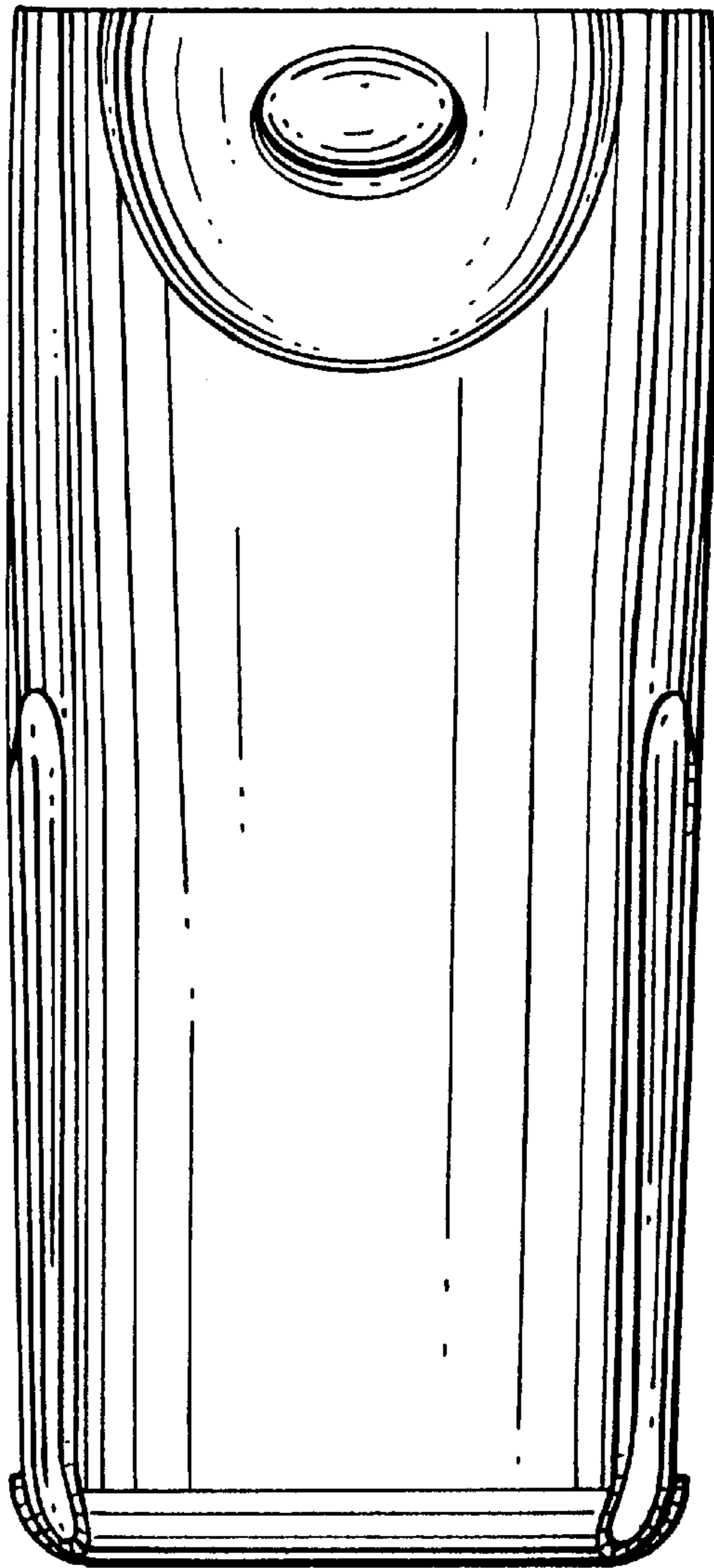
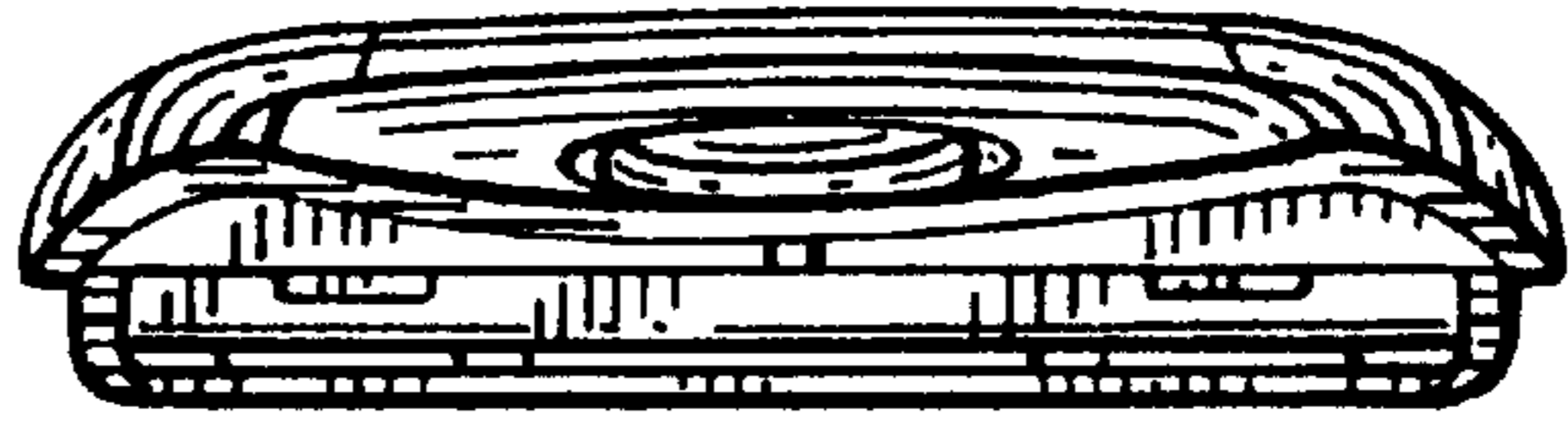

FIG. 6

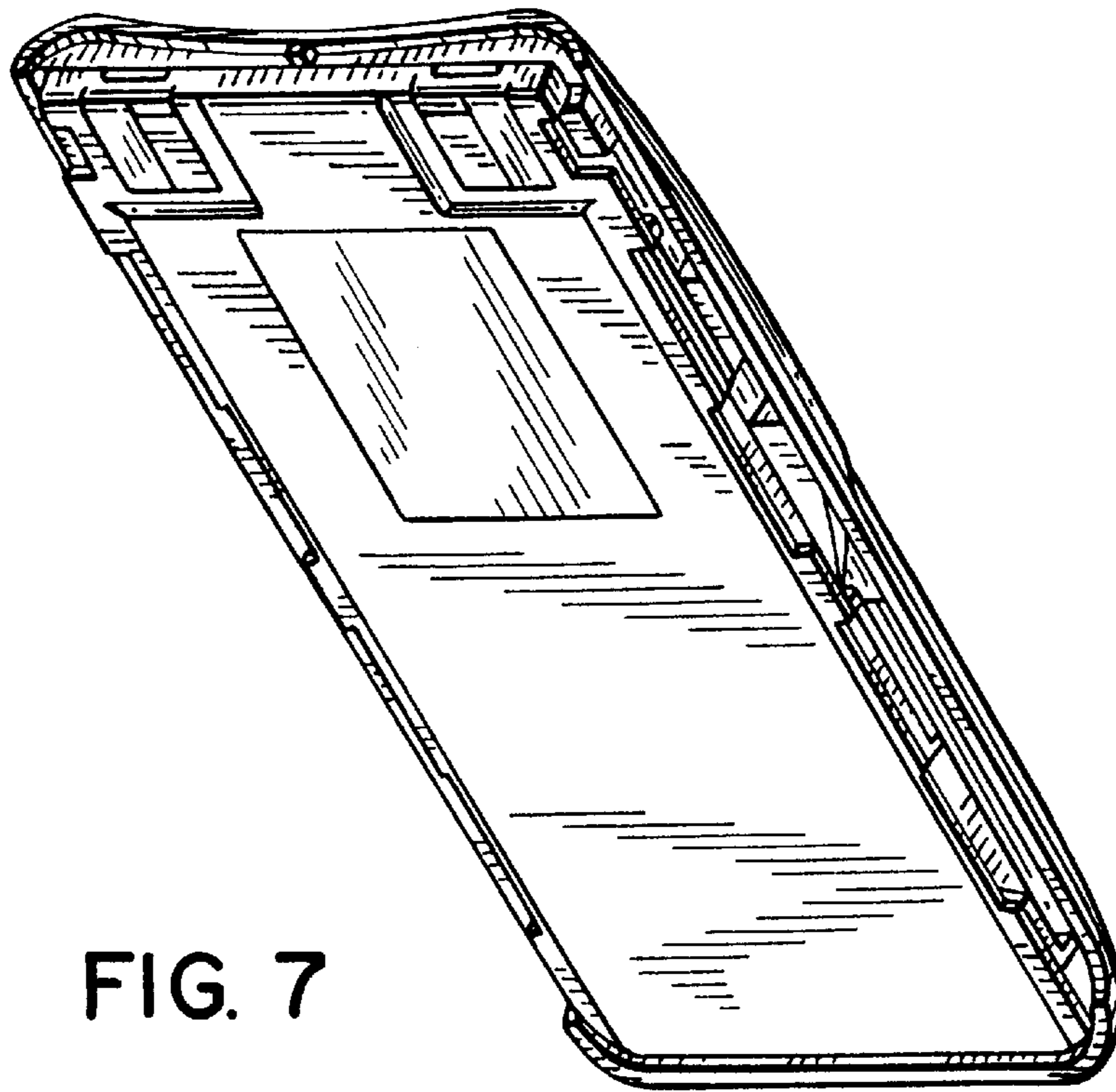

FIG. 7

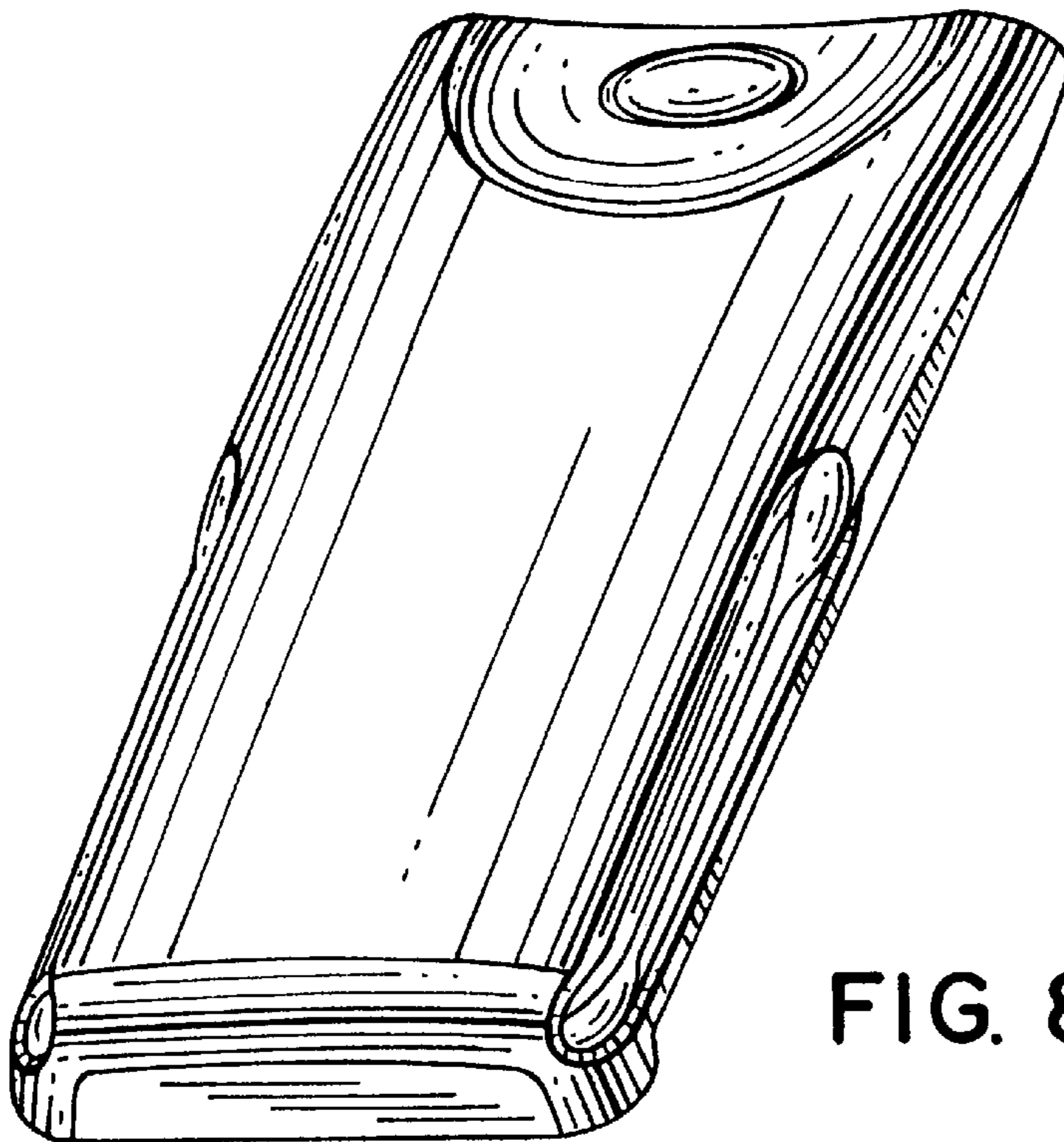

FIG. 8