



US00D410530S

United States Patent [19]
Turner

[11] **Patent Number: Des. 410,530**

[45] **Date of Patent: ** Jun. 1, 1999**

[54] **RAIN GUTTER COVER**

D. 382,944 8/1997 Kuhns D23/267
688,595 12/1901 Coe 52/11

[76] Inventor: **Karen Turner**, 230 Rock Hill St.,
Milledgeville, Ga. 31061

Primary Examiner—Marcus A. Jackson
Attorney, Agent, or Firm—Leonard Tachner

[**] Term: **14 Years**

[57] **CLAIM**

[21] Appl. No.: **29/062,029**

The ornamental design for a "rain gutter cover," as shown
and described.

[22] Filed: **Nov. 6, 1996**

DESCRIPTION

[51] **LOC (6) Cl.** **23-01**

[52] **U.S. Cl.** **D23/267**

[58] **Field of Search** D23/261, 266,
D23/267; D25/119, 124, 125; 248/48.1,
48.2; 52/11, 73.21

FIG. 1 is a three-dimensional view of a rain gutter cover in
accordance with a preferred embodiment of the present
invention;

FIG. 2 is a top elevational view of the invention;

FIG. 3 is a bottom elevational view thereof;

FIG. 4 is a side elevational view thereof, with the opposite
side being a mirror image;

FIG. 5 is a front elevational view thereof; and,

FIG. 6 is a rear elevational view thereof.

[56] **References Cited**

U.S. PATENT DOCUMENTS

- D. 223,829 6/1972 Cook D23/267
- D. 369,653 5/1996 Zaccagni D23/267
- D. 373,181 8/1996 Howard D23/261

1 Claim, 3 Drawing Sheets

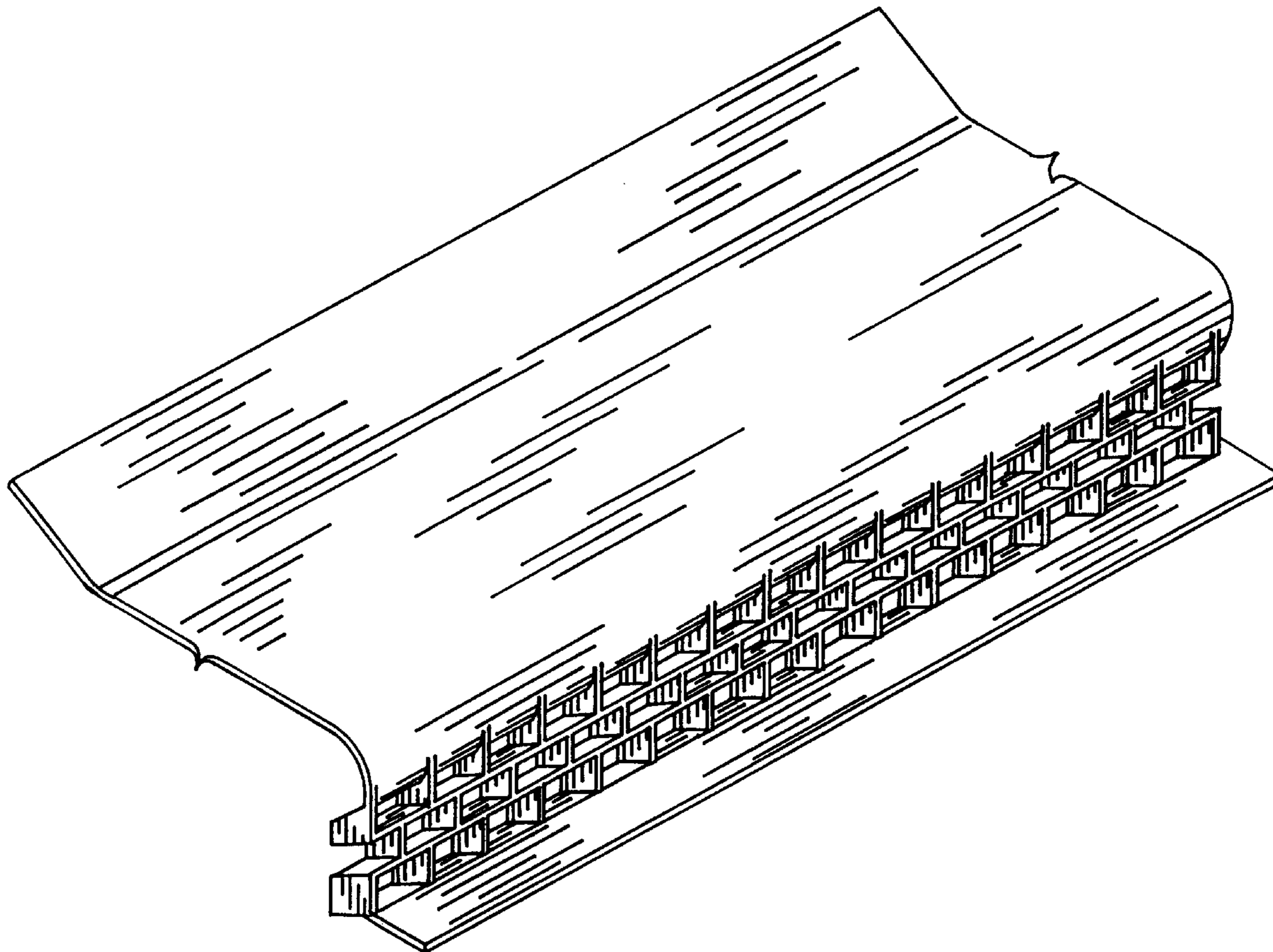

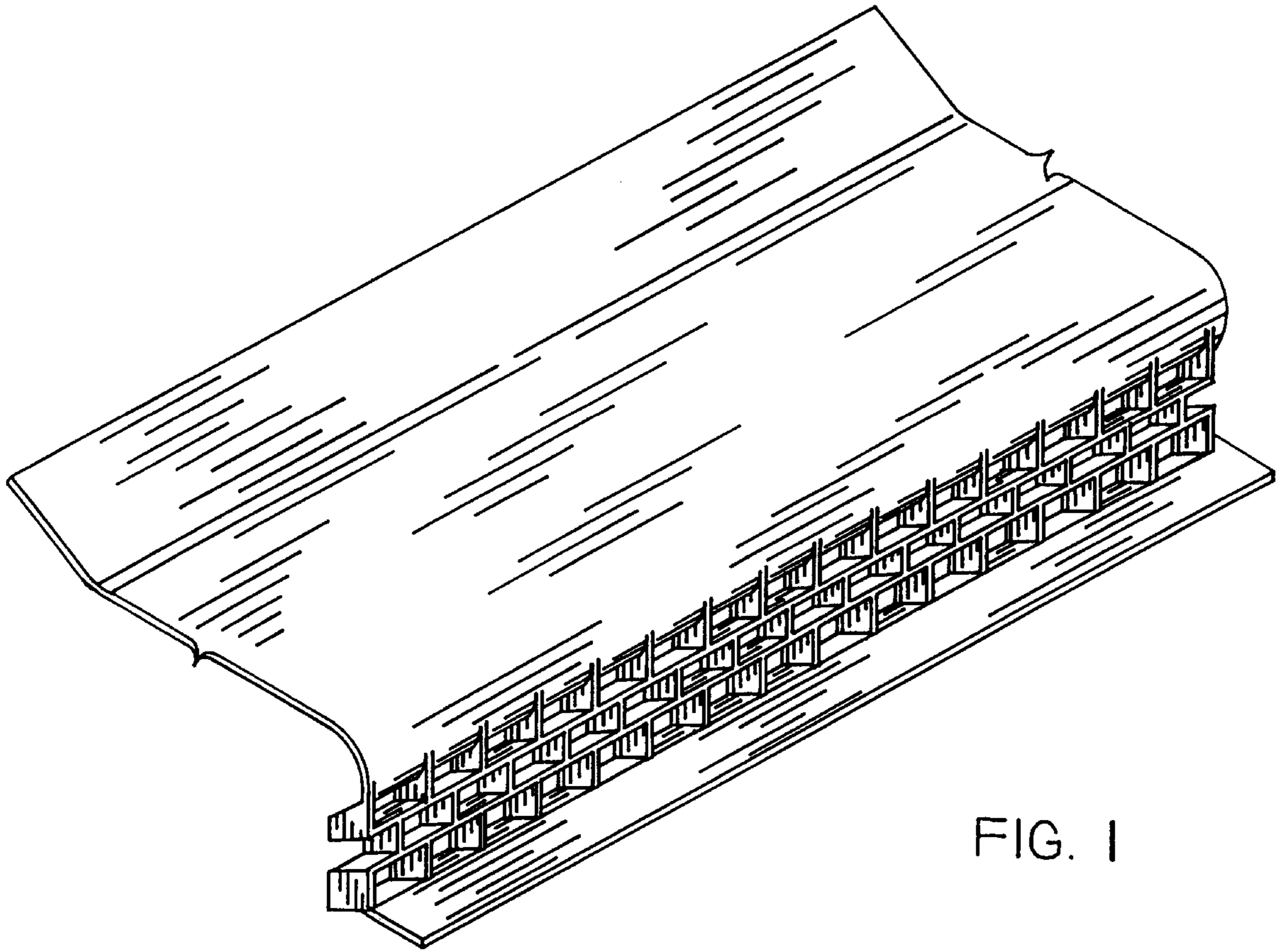

FIG. 1

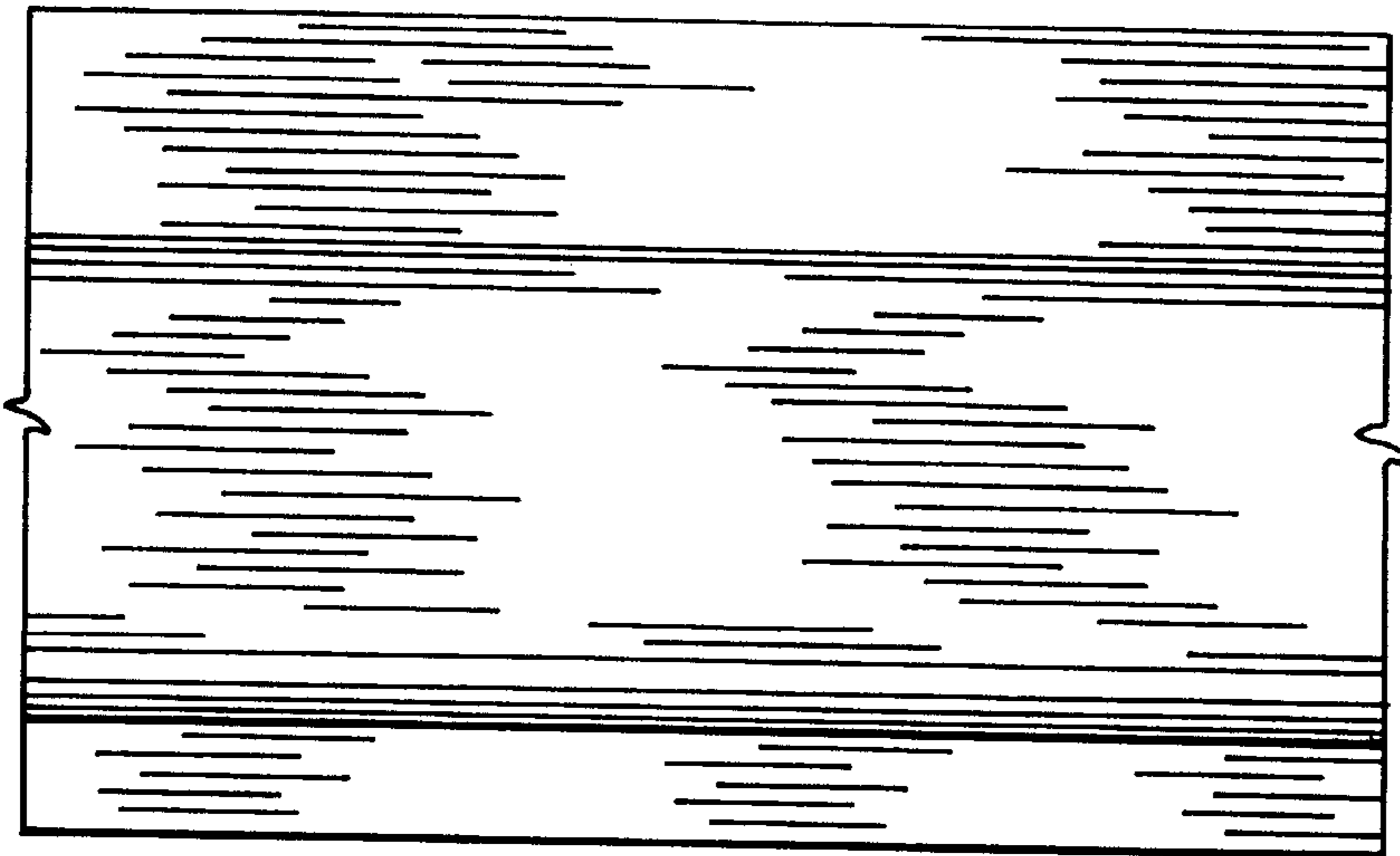

FIG. 2

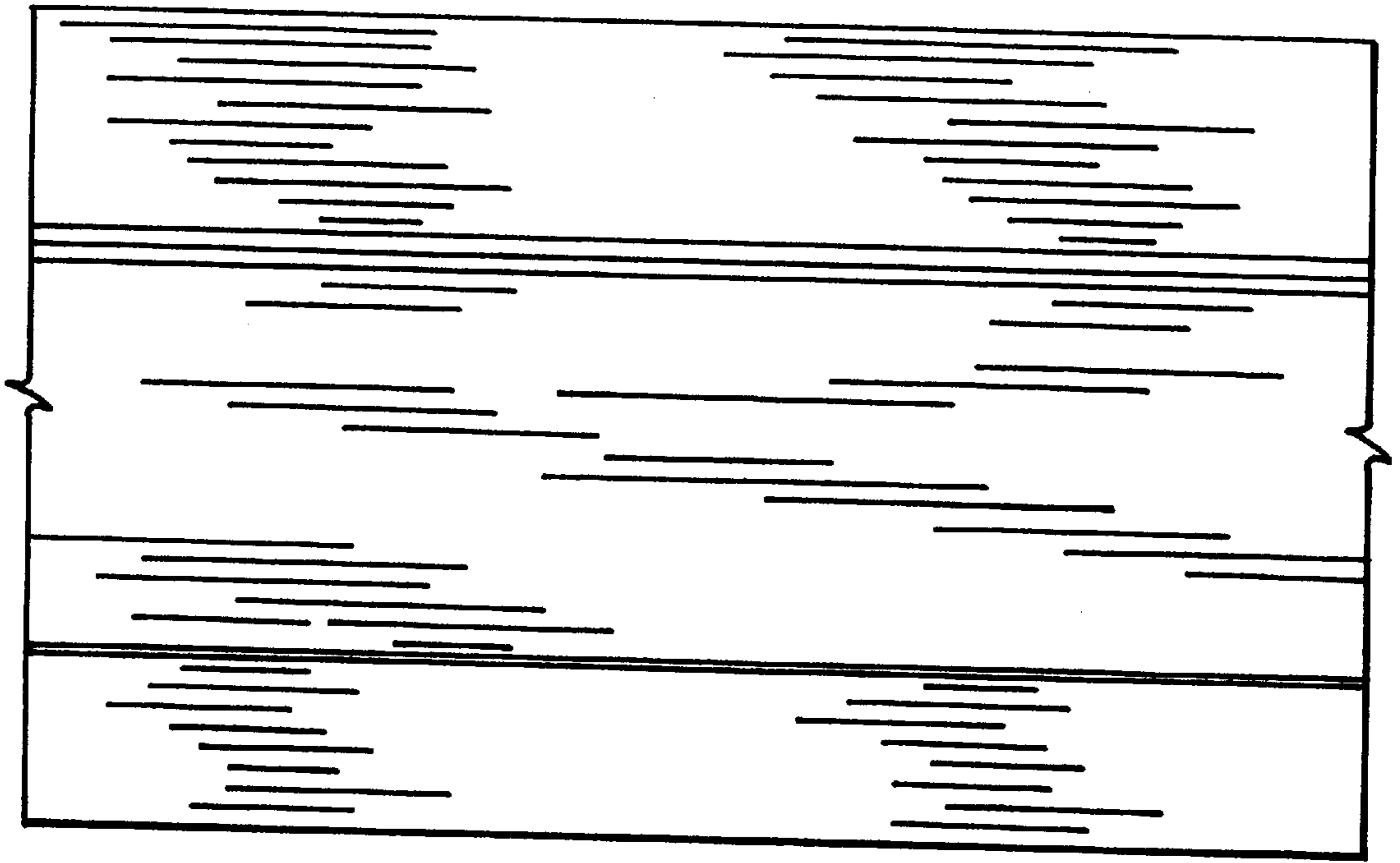

FIG. 3

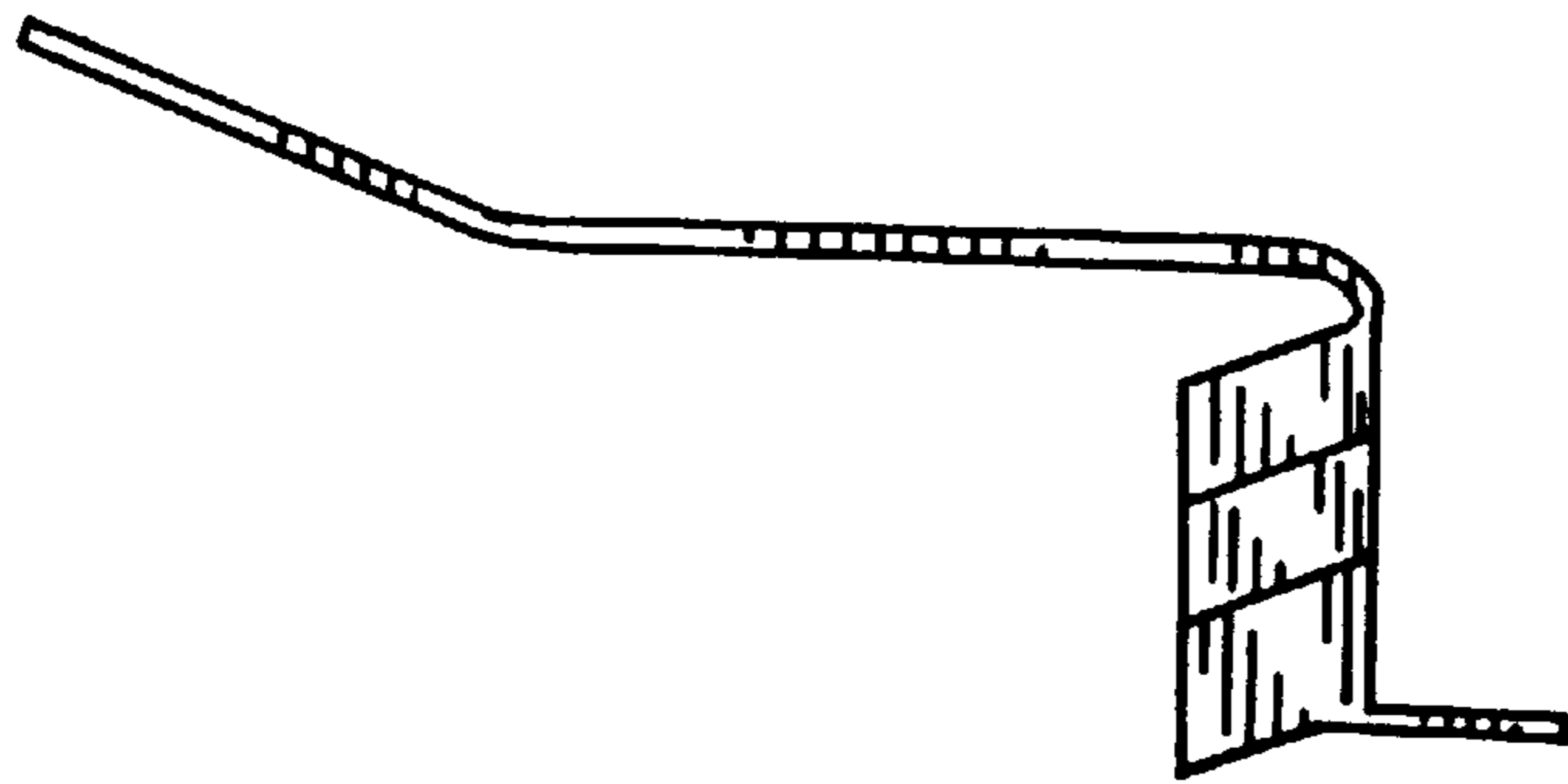

FIG. 4

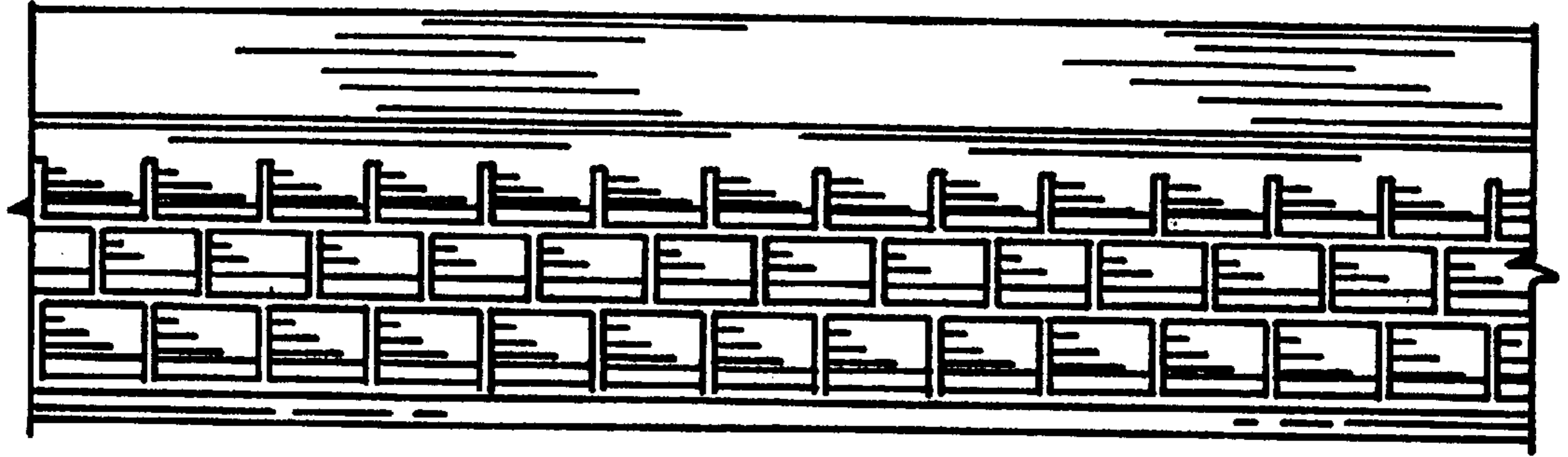

FIG. 5

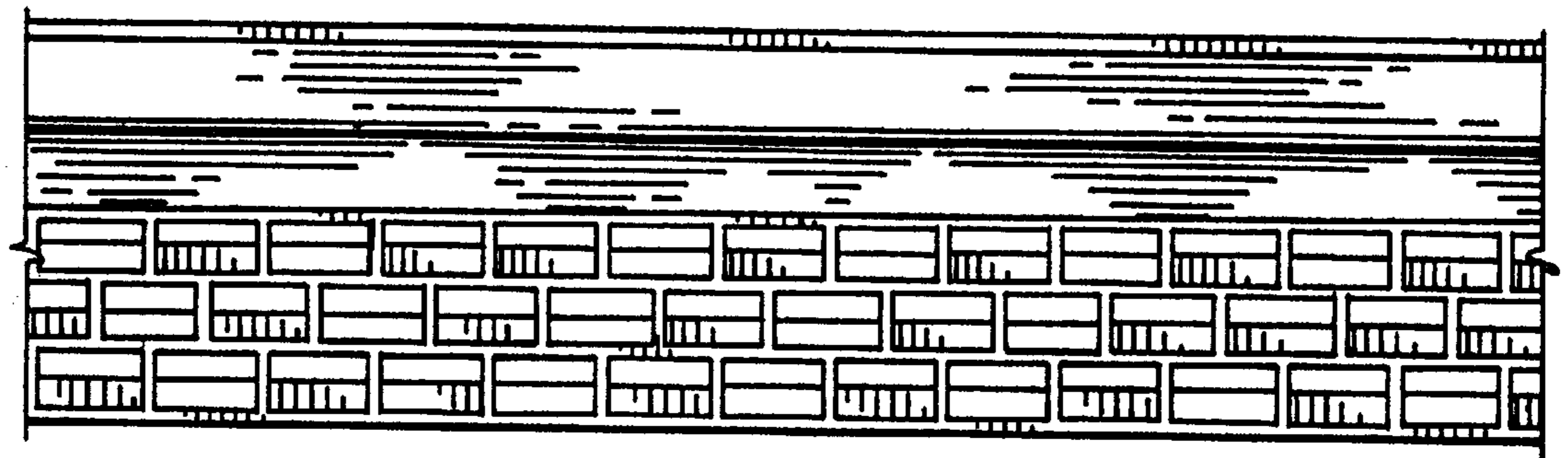

FIG. 6