



US00D410480S

United States Patent [19] Takagi

[11] **Patent Number: Des. 410,480**
[45] **Date of Patent: ** Jun. 1, 1999**

[54] **VIDEO CAMERA**

[75] Inventor: **Noriaki Takagi**, Tokyo, Japan

[73] Assignee: **Sony Corporation**, Tokyo, Japan

[**] Term: **14 Years**

[21] Appl. No.: **29/079,159**

[22] Filed: **Nov. 17, 1997**

[30] Foreign Application Priority Data

May 21, 1997 [JP] Japan 9-55005

[51] **LOC (6) Cl.** **16-01**

[52] **U.S. Cl.** **D16/202**

[58] **Field of Search** D16/200-208,
D16/216-218; 348/373-376; 358/906, 909.1;
396/535-543

[56] References Cited

U.S. PATENT DOCUMENTS

D. 296,551 7/1988 Mizogui D16/202

D. 340,253 10/1993 Fedorczak D16/203
D. 357,929 5/1995 Pierce D16/202
D. 396,240 7/1998 Hasegawa D16/202
5,610,678 3/1997 Tsuboi et al. 348/375

Primary Examiner—Adir Aronovich
Attorney, Agent, or Firm—Foley & Lardner

[57] CLAIM

The ornamental design for a video camera, as shown and described.

DESCRIPTION

FIG. 1 is a perspective view of a video camera showing my new design;
FIG. 2 is a top plan view thereof;
FIG. 3 is a left side elevational view thereof;
FIG. 4 is a front elevational view thereof;
FIG. 5 is a bottom plan view thereof;
FIG. 6 is a right side elevational view thereof; and,
FIG. 7 is a rear elevational view thereof.

1 Claim, 3 Drawing Sheets

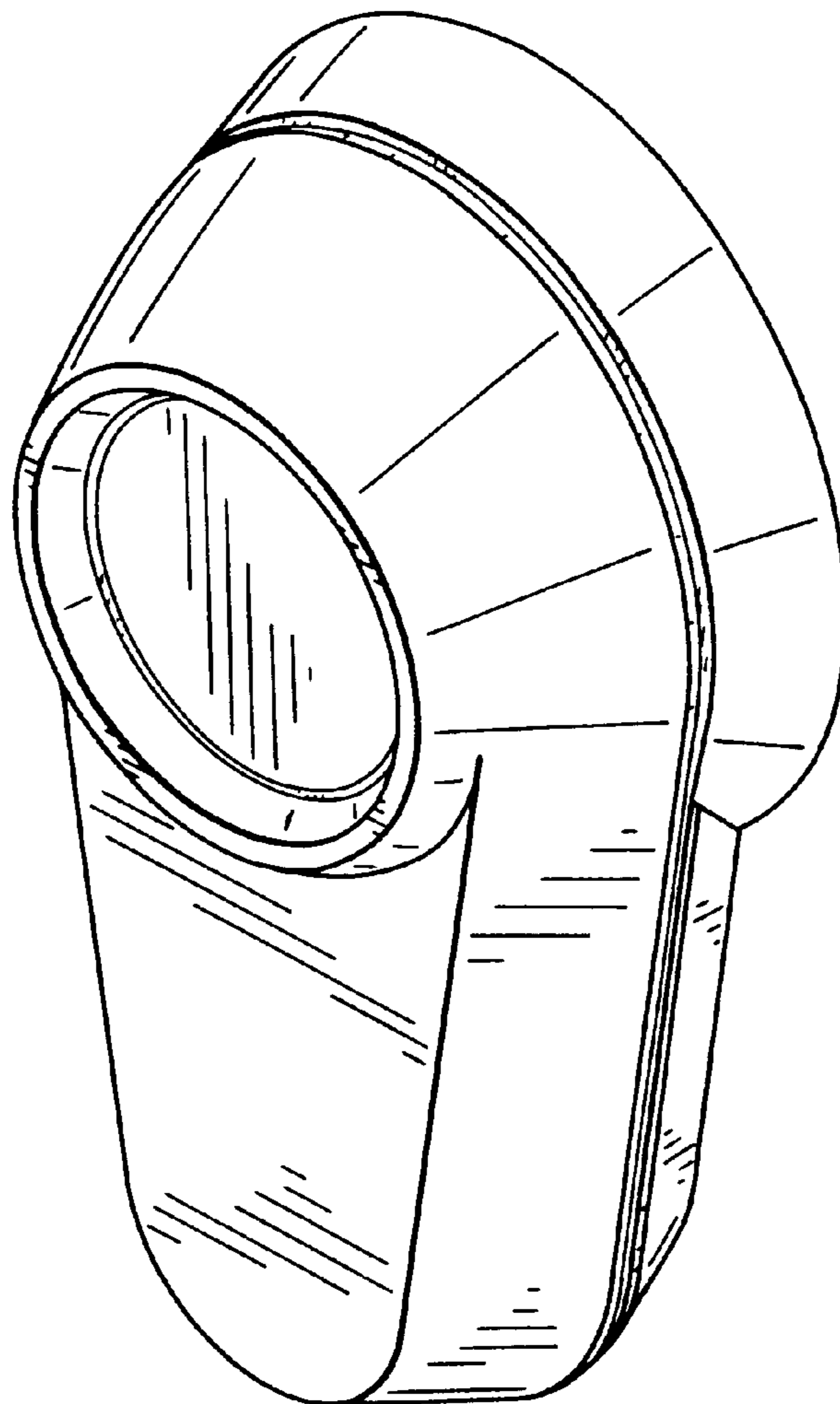
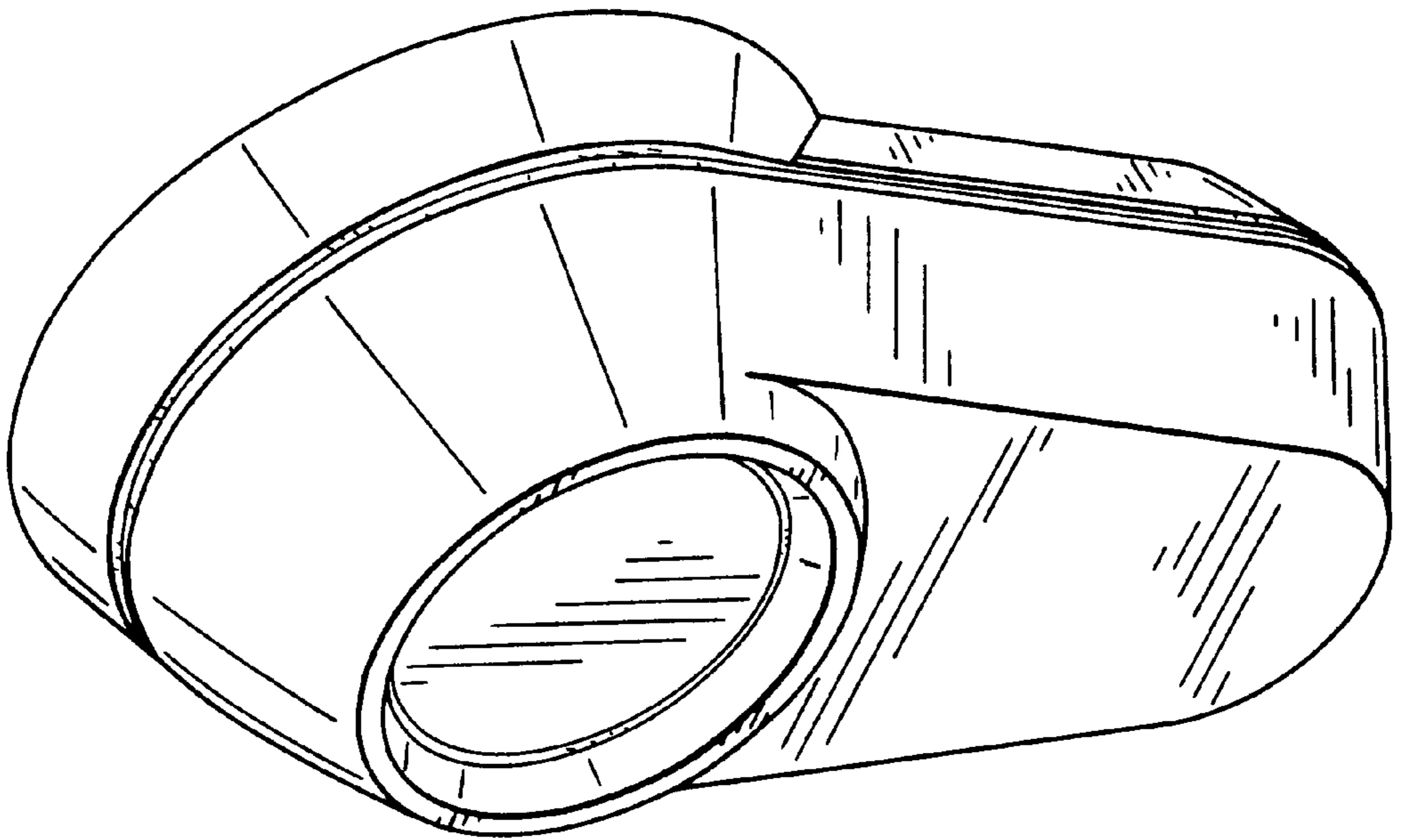

FIG. 1



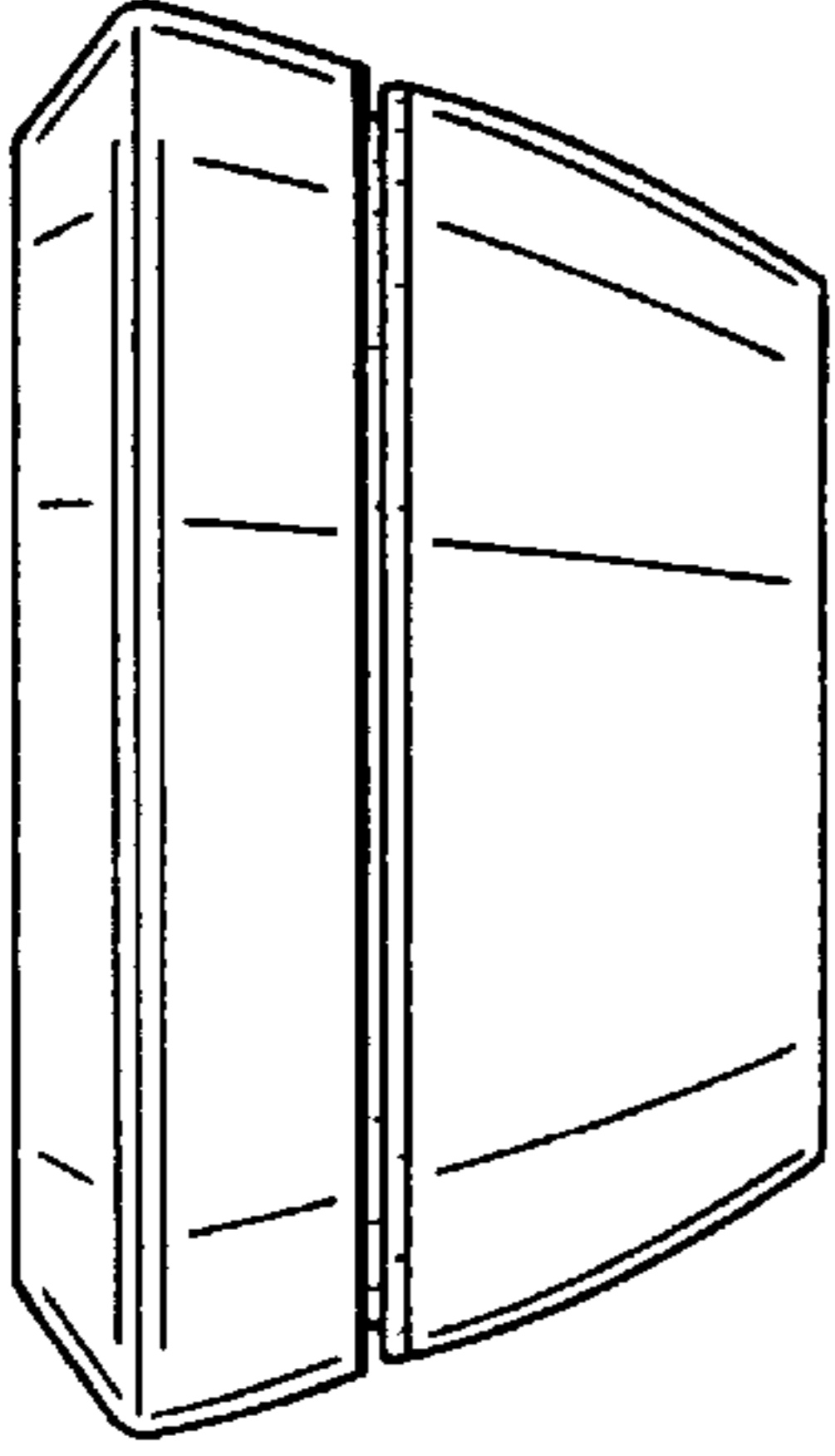

FIG. 2

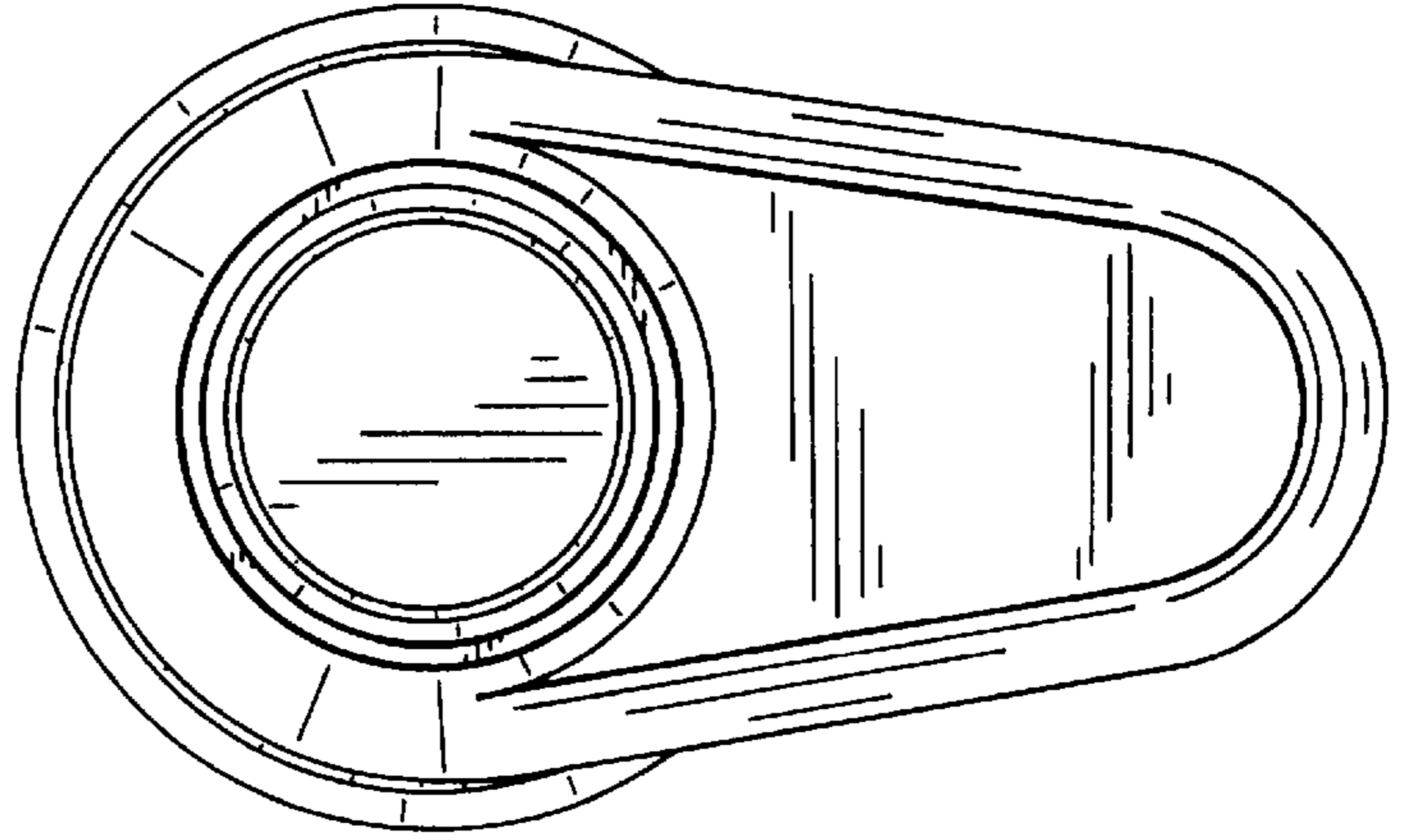

FIG. 4

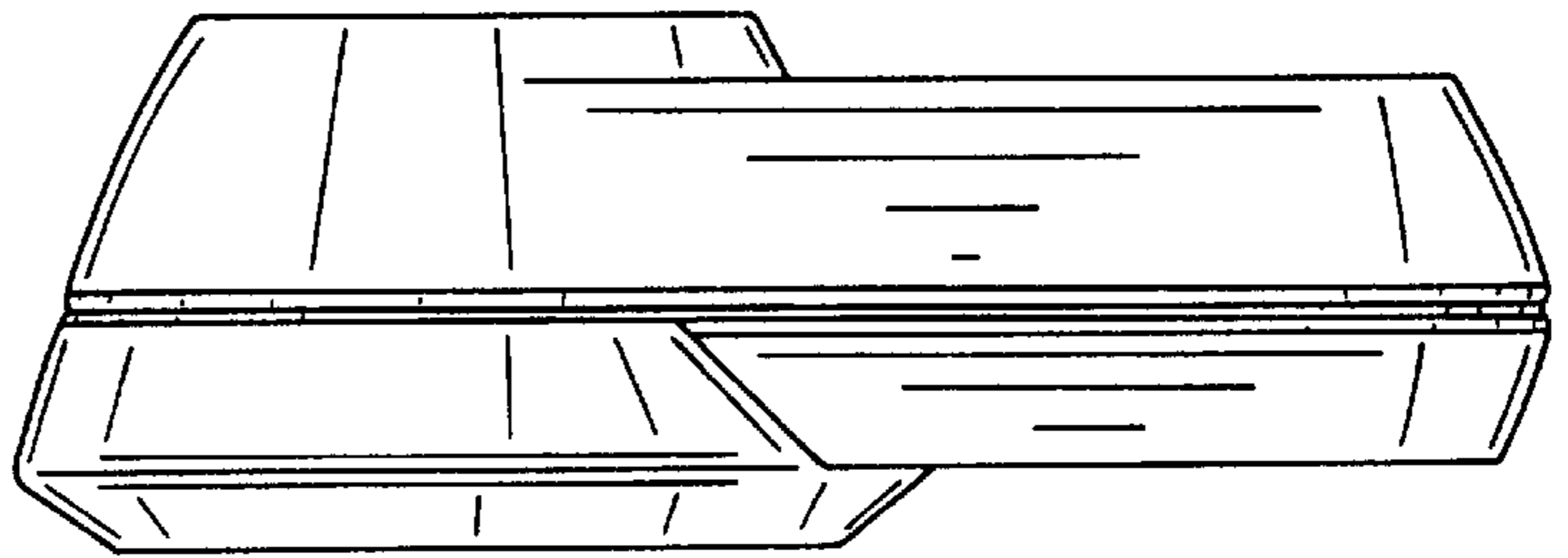

FIG. 3

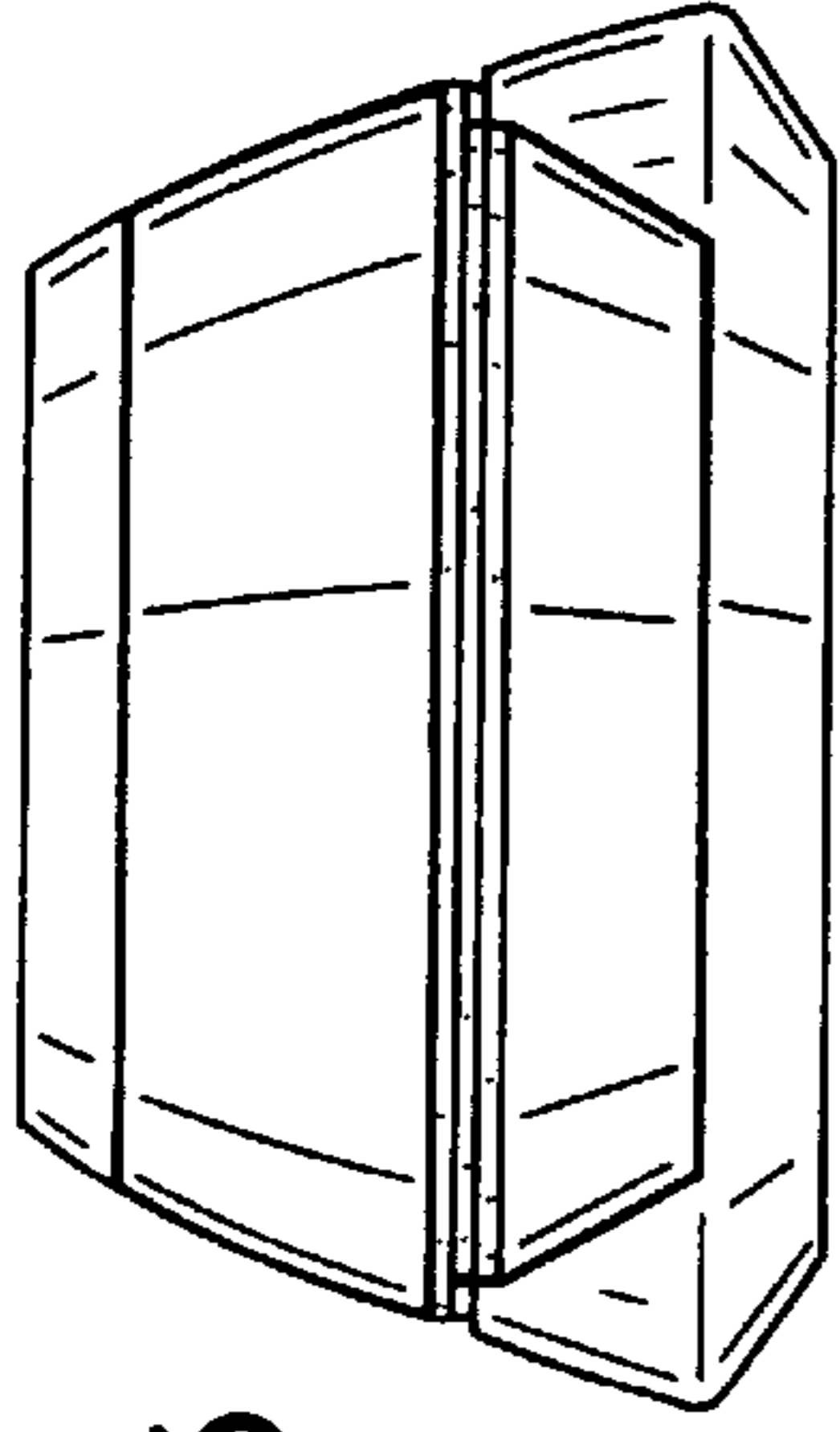

FIG. 5

FIG. 7

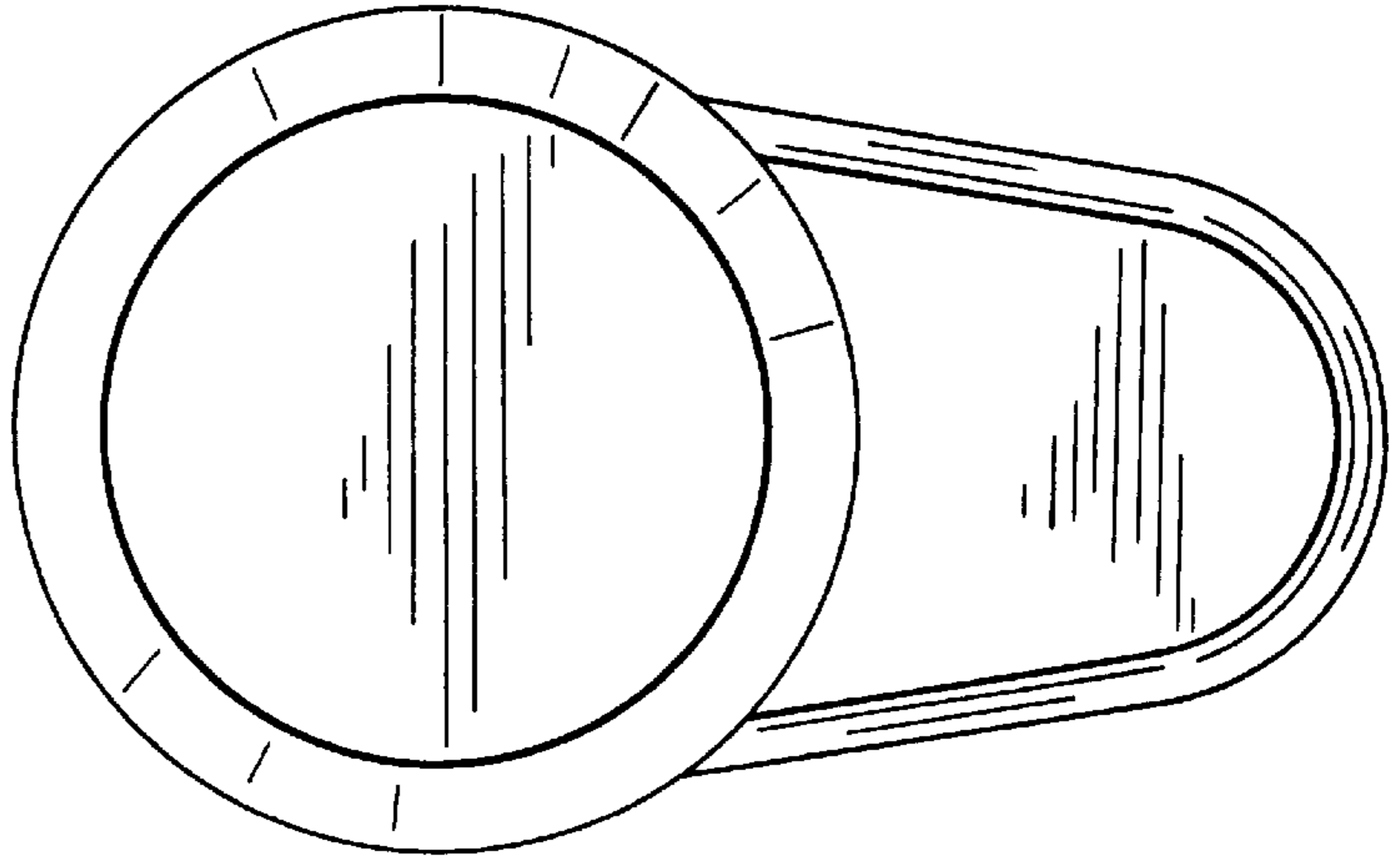

FIG. 6

