



US00D410435S

**United States Patent** [19]  
**Hambleton**

[11] **Patent Number: Des. 410,435**

[45] **Date of Patent: \*\* Jun. 1, 1999**

[54] **PLUG BOX**

[76] Inventor: **Brian Hambleton**, 4009 S. Pearl,  
Englewood, Colo. 80110

[\*\*] Term: **14 Years**

[21] Appl. No.: **29/086,929**

[22] Filed: **Apr. 23, 1998**

[51] **LOC (6) Cl. .... 13-03**

[52] **U.S. Cl. .... D13/156**

[58] **Field of Search .... D13/156, 154;**  
439/133, 134, 149, 521; 174/67; 220/3.8

[56] **References Cited**

**U.S. PATENT DOCUMENTS**

D. 325,374	4/1992	Ashby .....	D13/154
D. 386,149	11/1997	Malone, Sr. et al. ....	D13/156
4,705,335	11/1987	Goebel .....	439/133
4,865,557	9/1989	Kershaw .....	439/133
5,566,847	10/1996	Ali et al. ....	220/3.8 X

*Primary Examiner*—Joel Sincavage  
*Attorney, Agent, or Firm*—Dorr, Carson, Sloan, & Birney,  
P.C.

[57] **CLAIM**

The ornamental design for a plug box, as shown and described.

**DESCRIPTION**

FIG. 1 is a front perspective view of a plug box showing my new design with the lid open.

FIG. 2 is a front perspective view of the plug box with the lid closed.

FIG. 3 is a left side elevational view of the plug box, with the right side elevational view being a mirror image of FIG. 3.

FIG. 4 is a top plan view of the plug box.

FIG. 5 is a rear elevational view of the plug box.

FIG. 6 is a front elevational view of the plug box.

FIG. 7 is a bottom plan view of the plug box.

FIG. 8 is a front perspective view of an alternative embodiment of the plug box.

FIG. 9 is a left side elevational view of the plug box corresponding to FIG. 8, with the right side elevational view being a mirror image of FIG. 9.

FIG. 10 is a top plan view of the plug box corresponding to FIG. 8.

FIG. 11 is front elevational view of the plug box corresponding to FIG. 8.

FIG. 12 is a rear elevational view of the plug box corresponding to FIG. 8; and,

FIG. 13 is a bottom plan view of the plug box corresponding to FIG. 8.

**1 Claim, 6 Drawing Sheets**

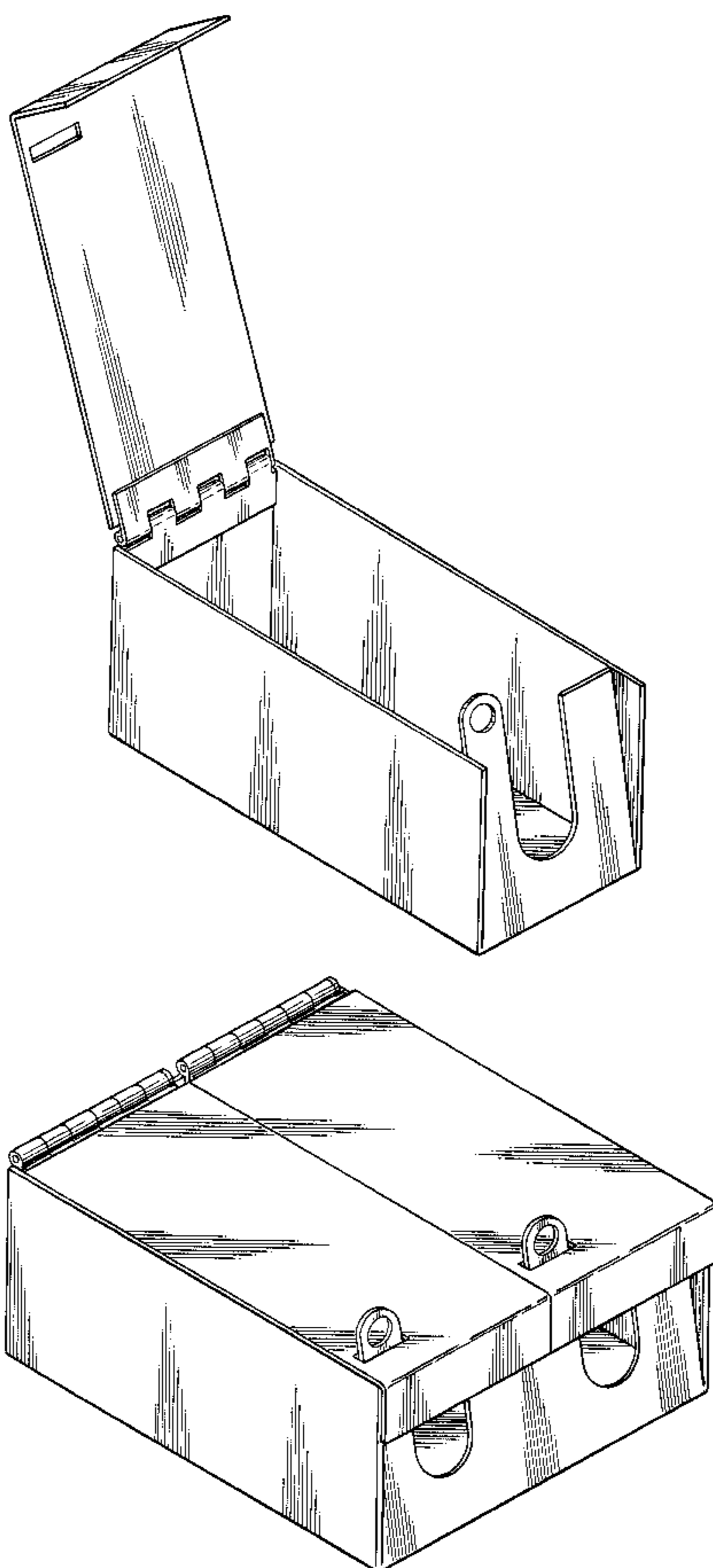

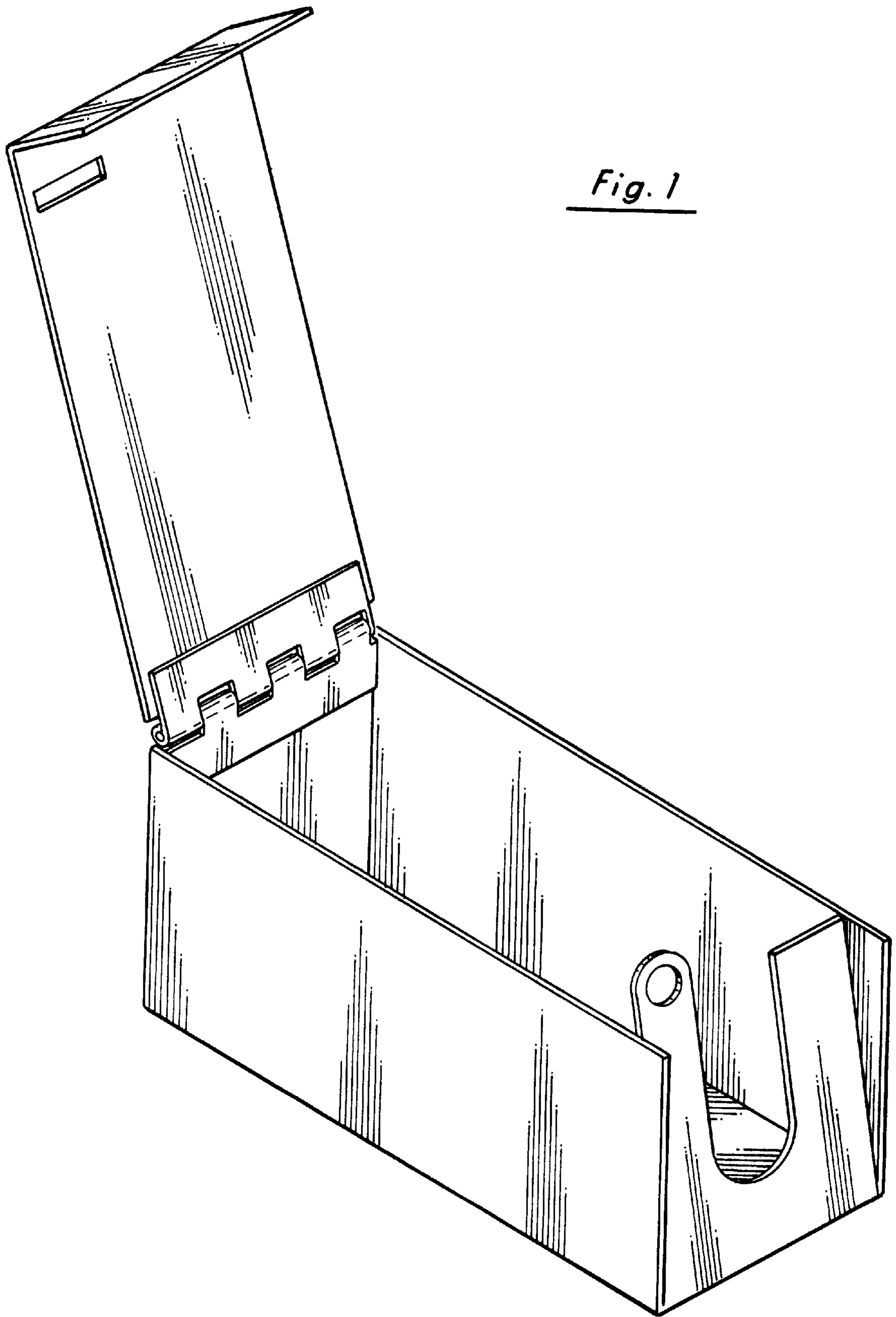

Fig. 1

Fig. 2

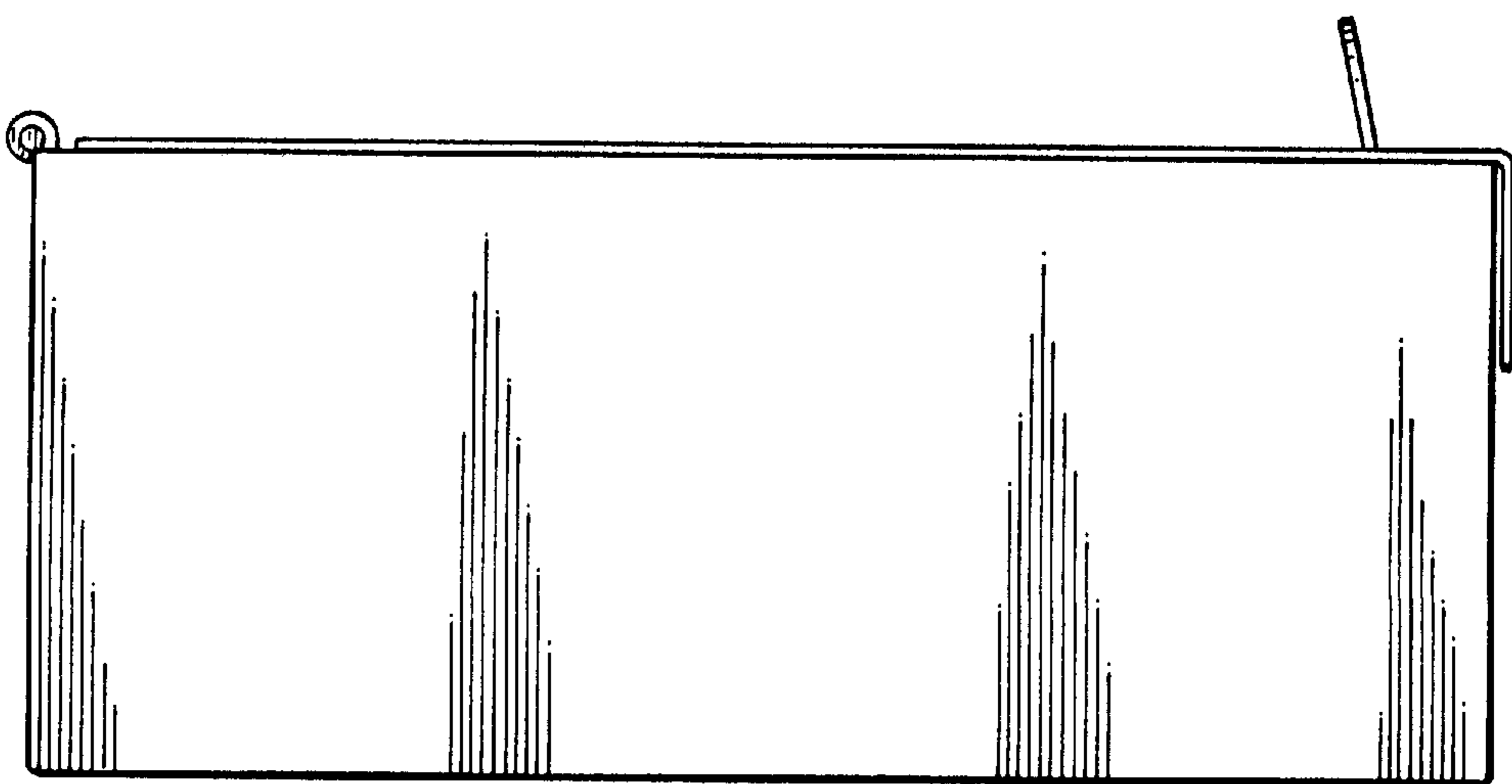
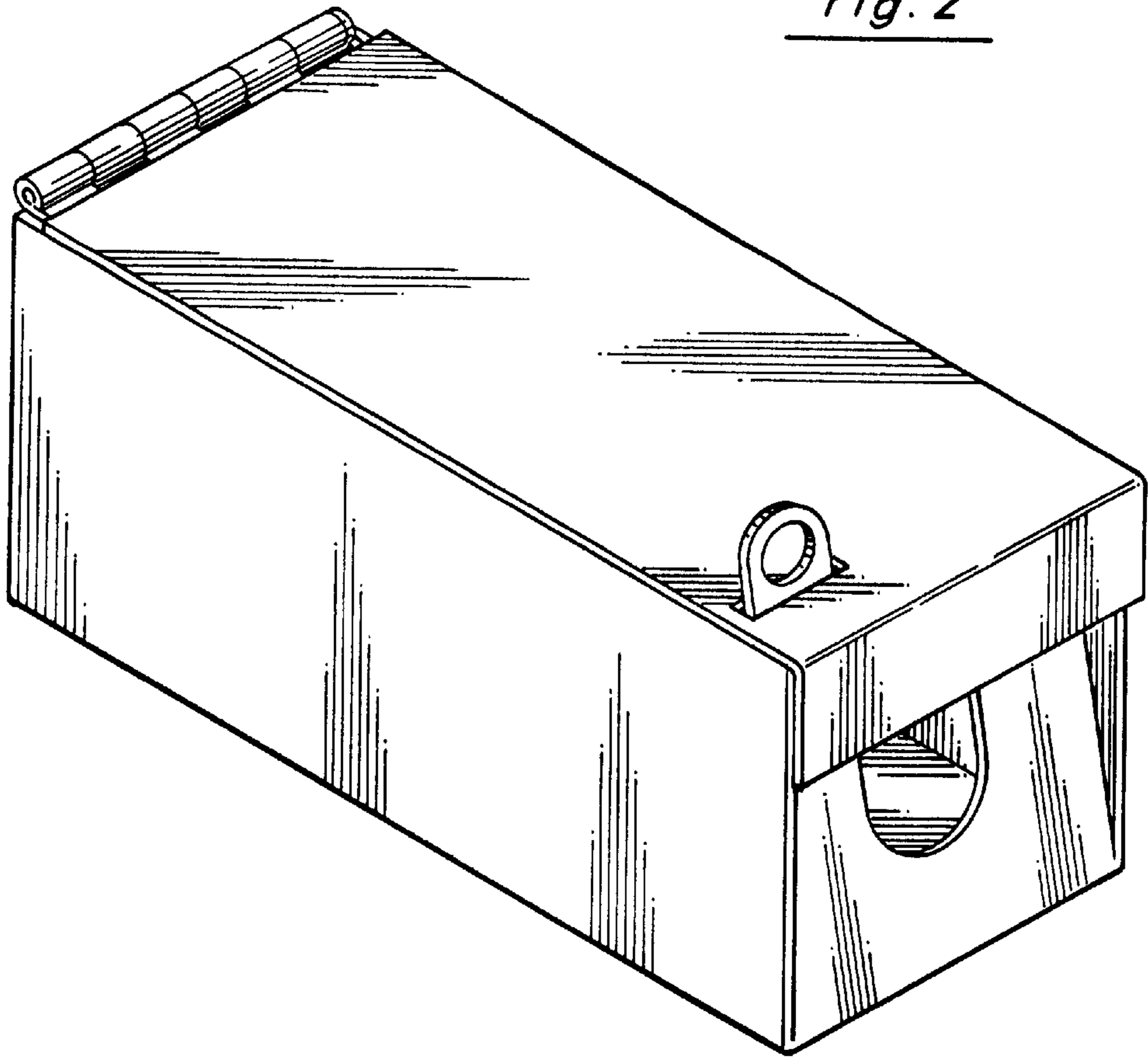

Fig. 3

Fig. 4

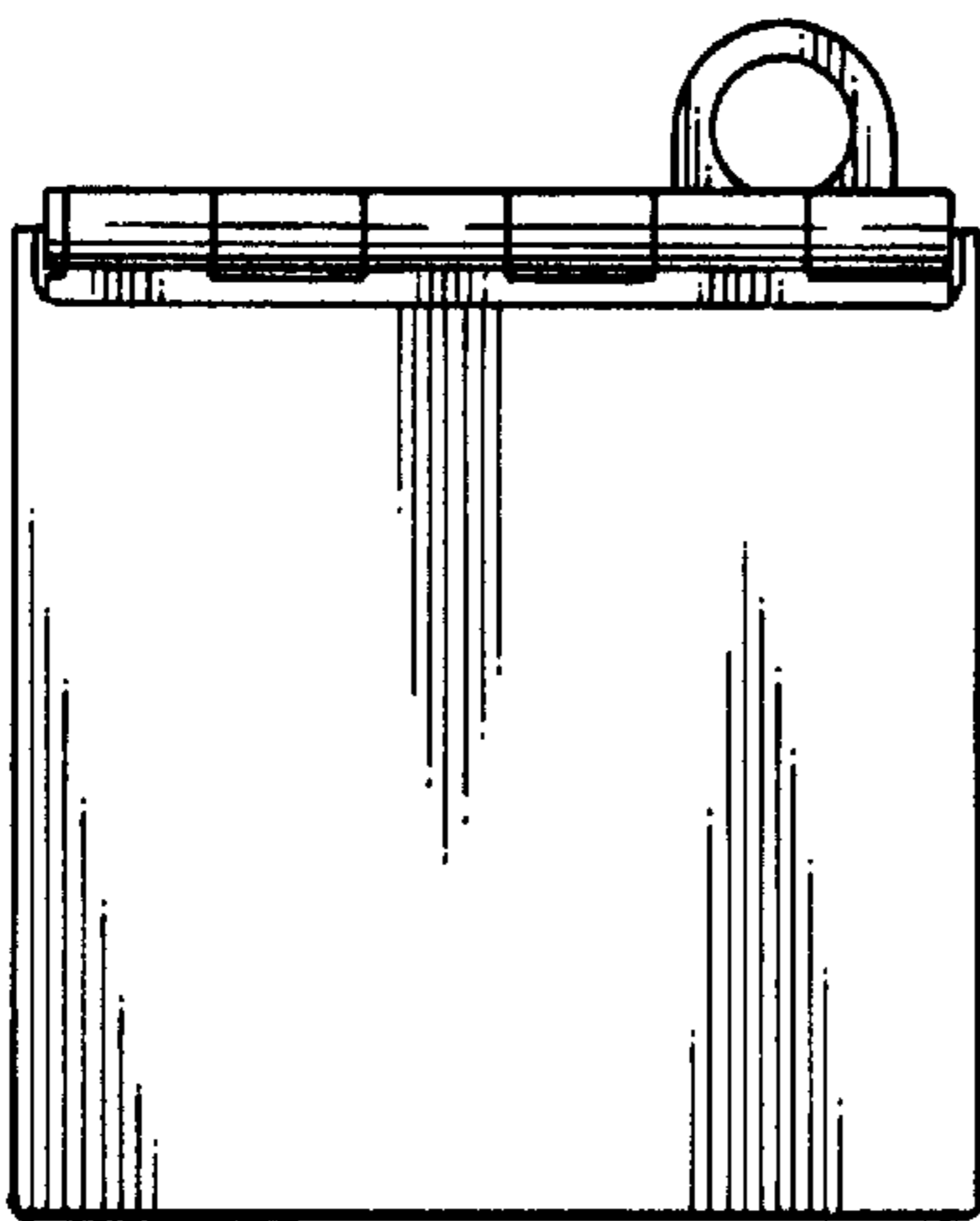
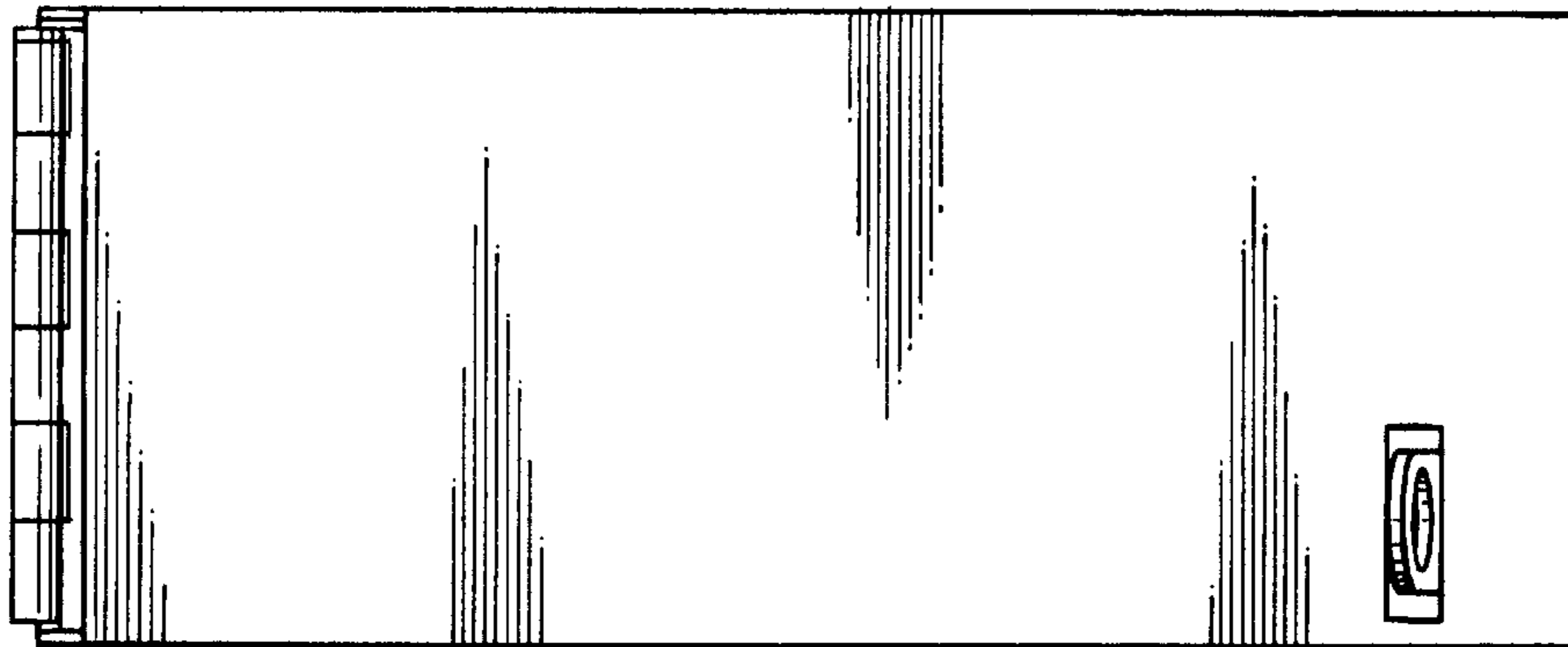

Fig. 5

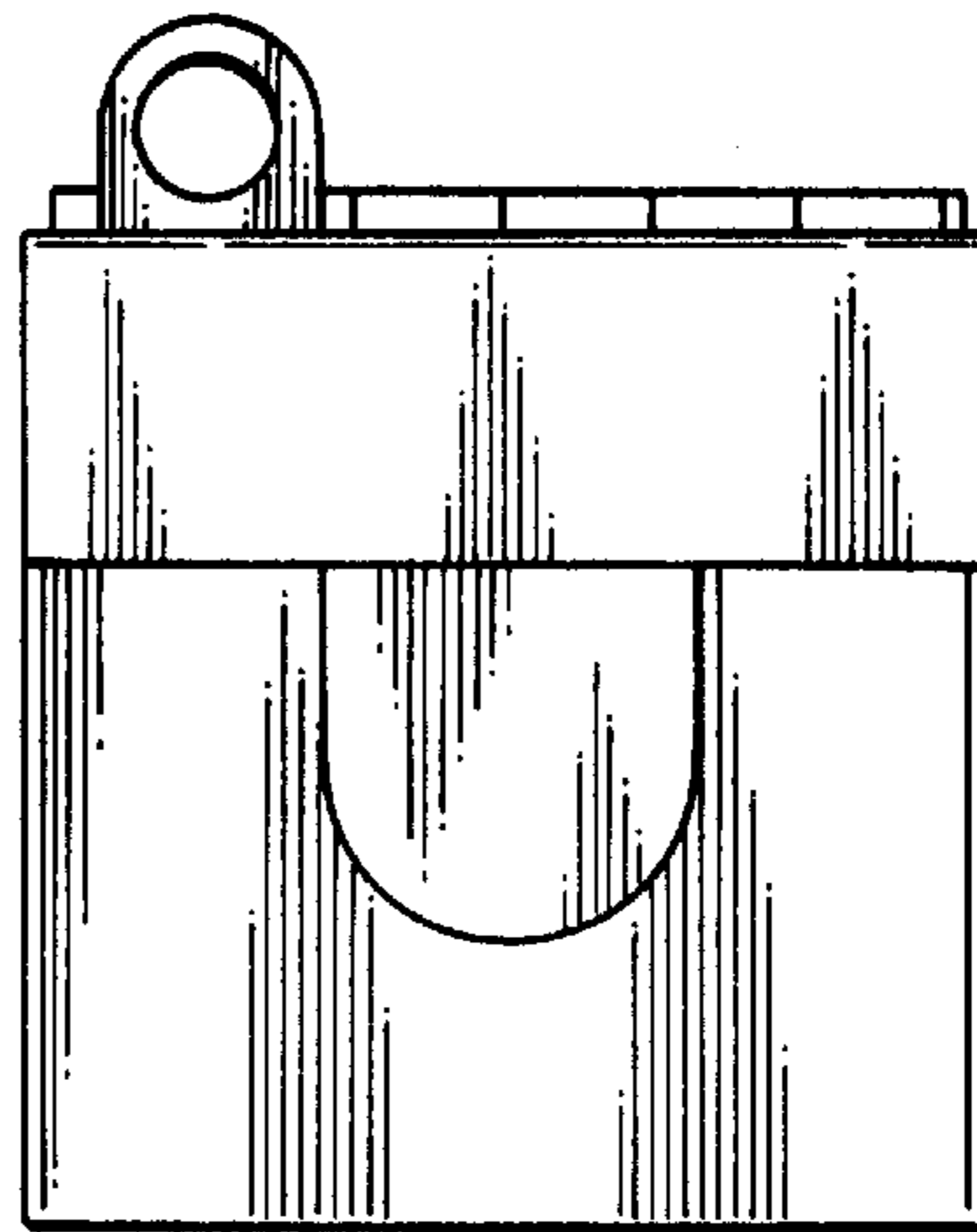

Fig. 6

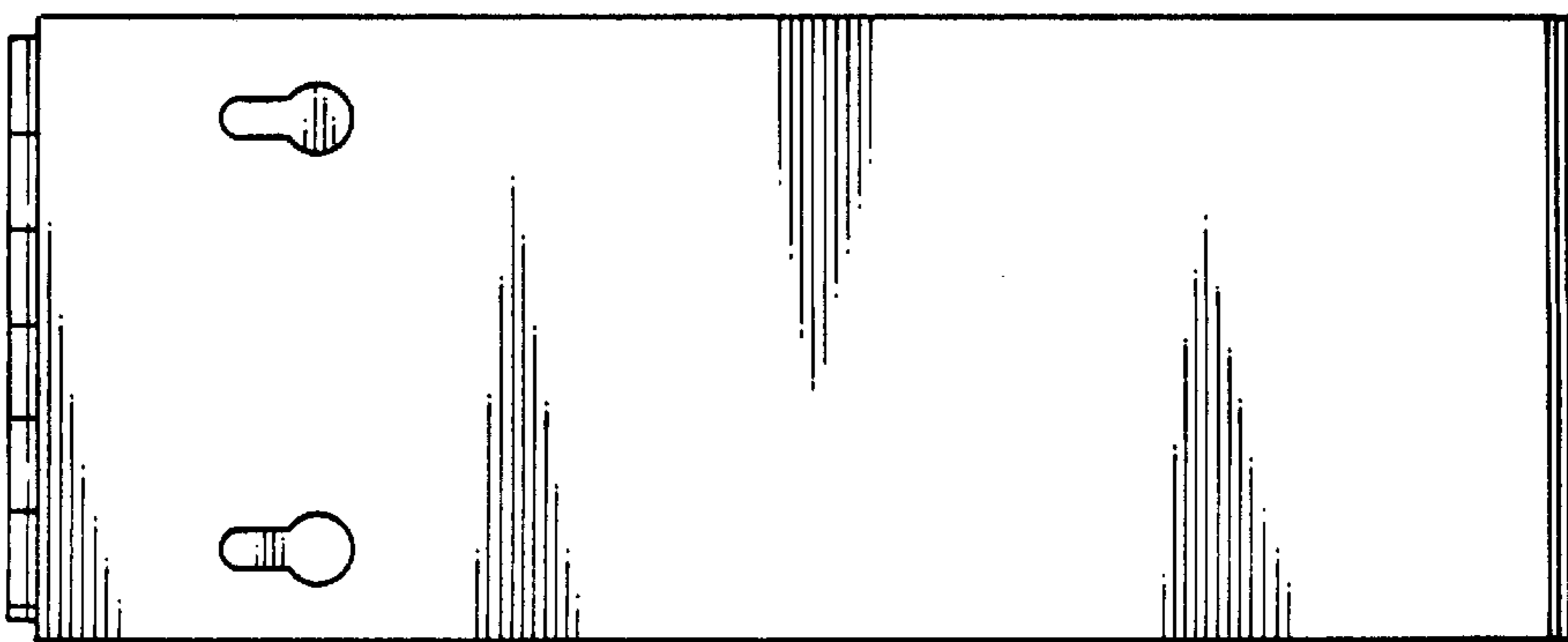

Fig. 7

Fig. 8

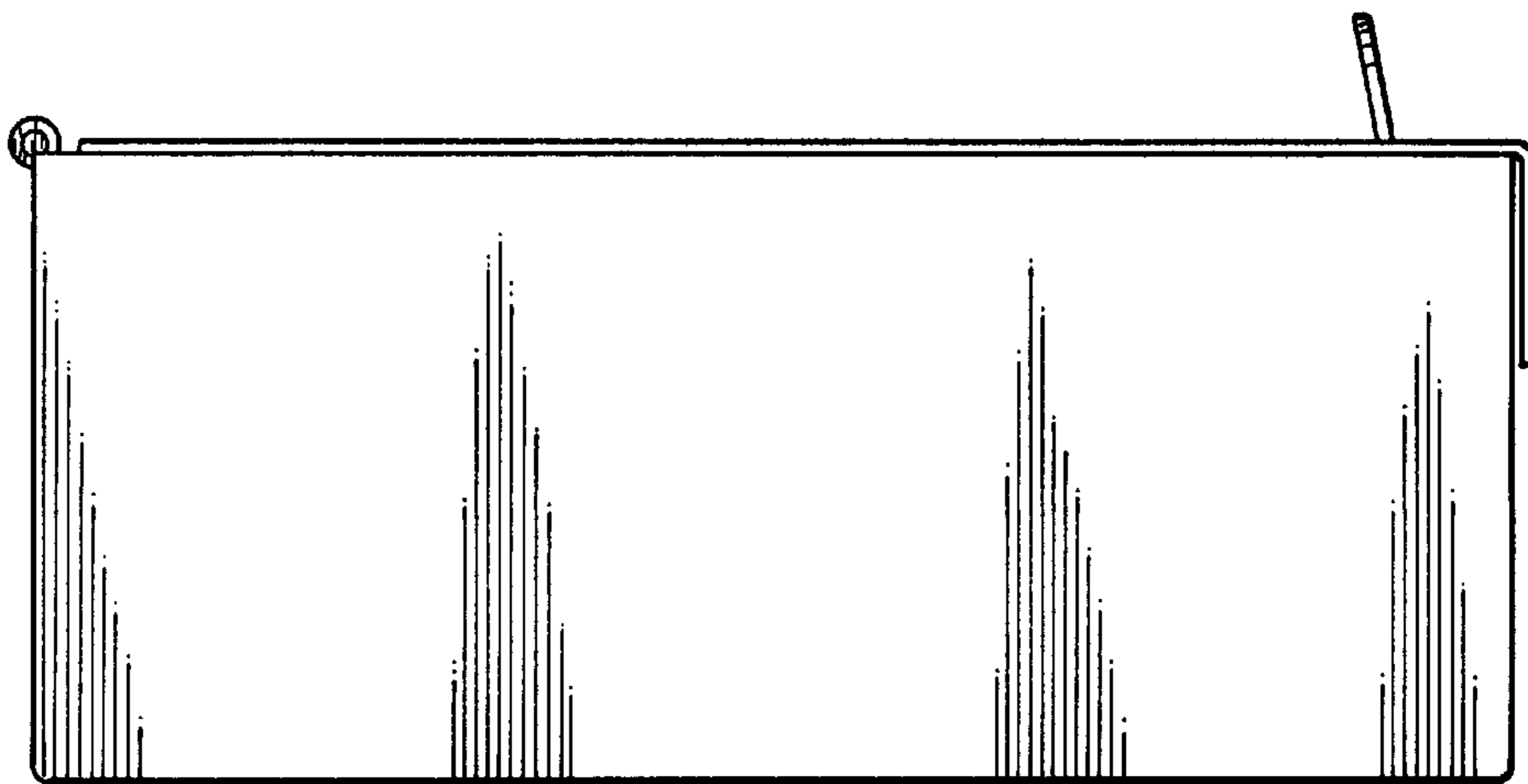
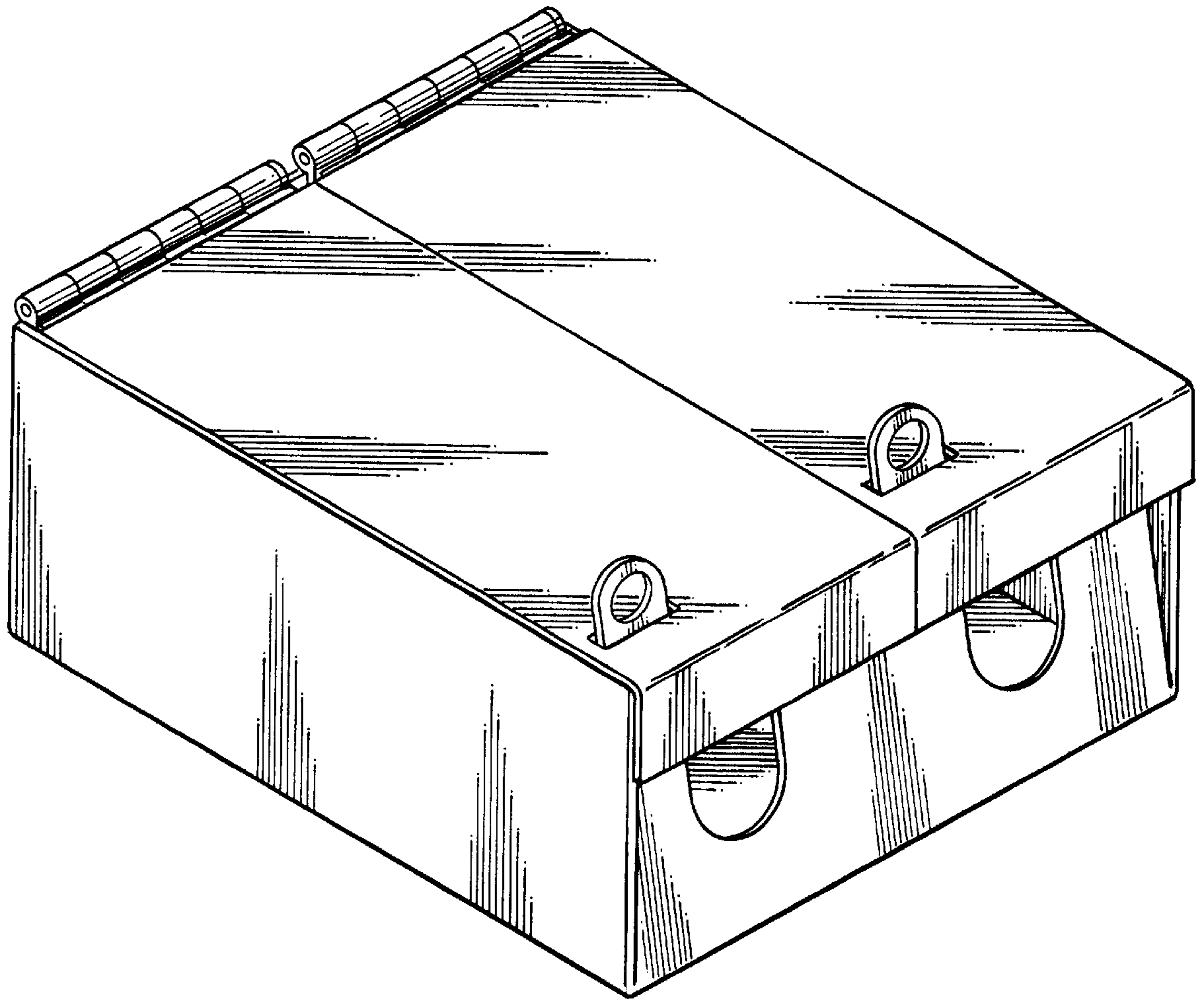

Fig. 9



Fig. 10

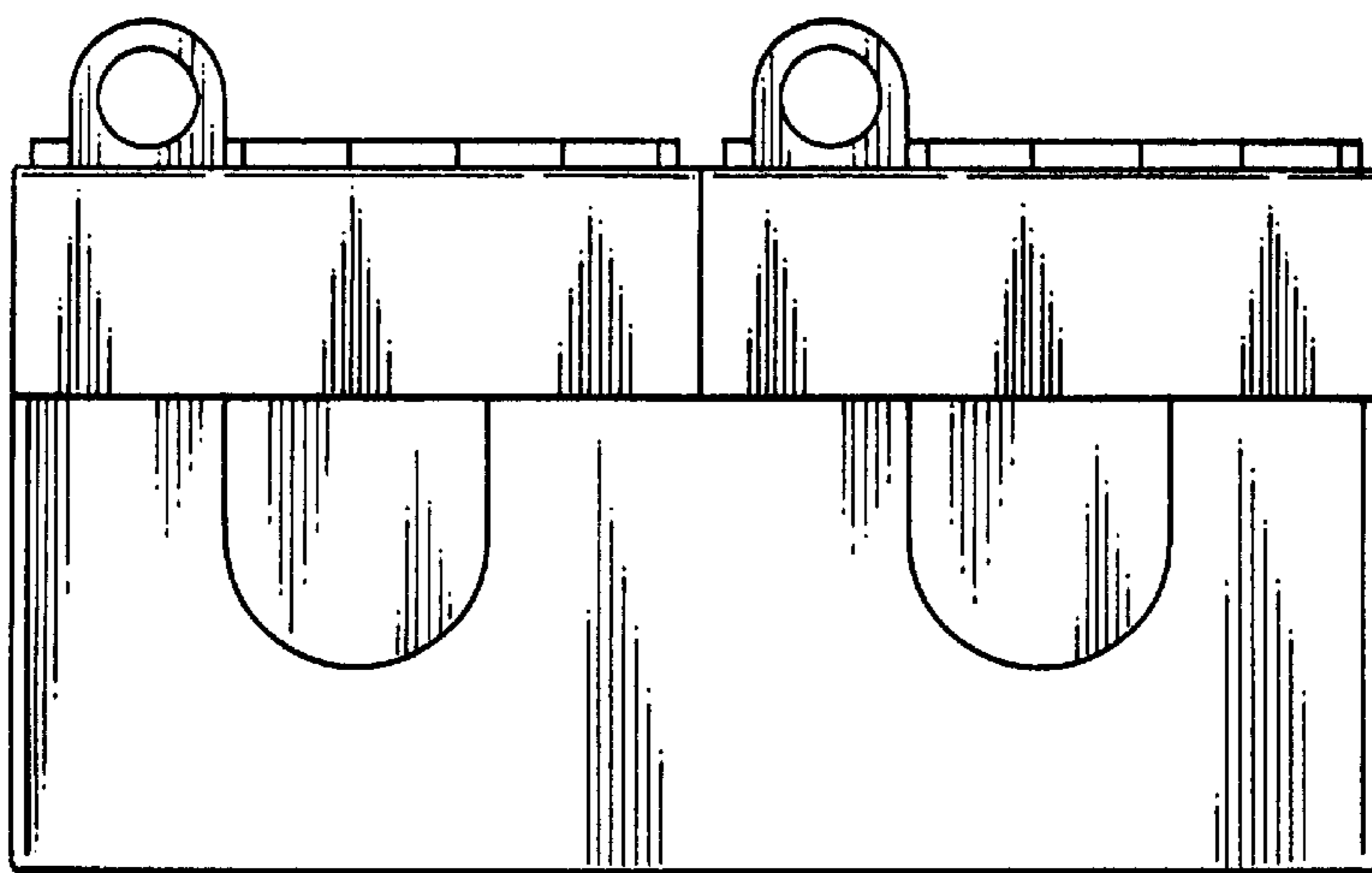
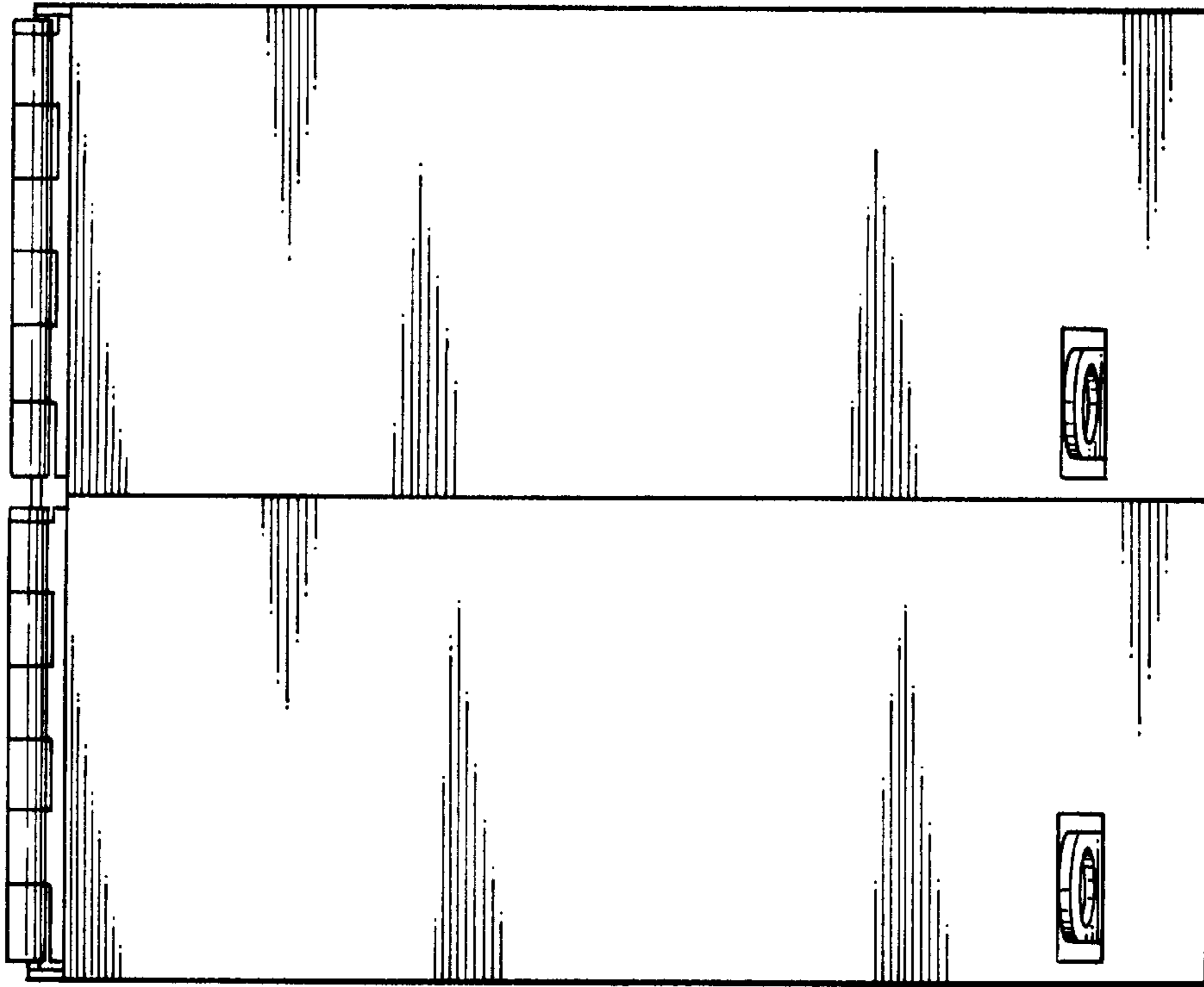

Fig. 11

Fig. 12

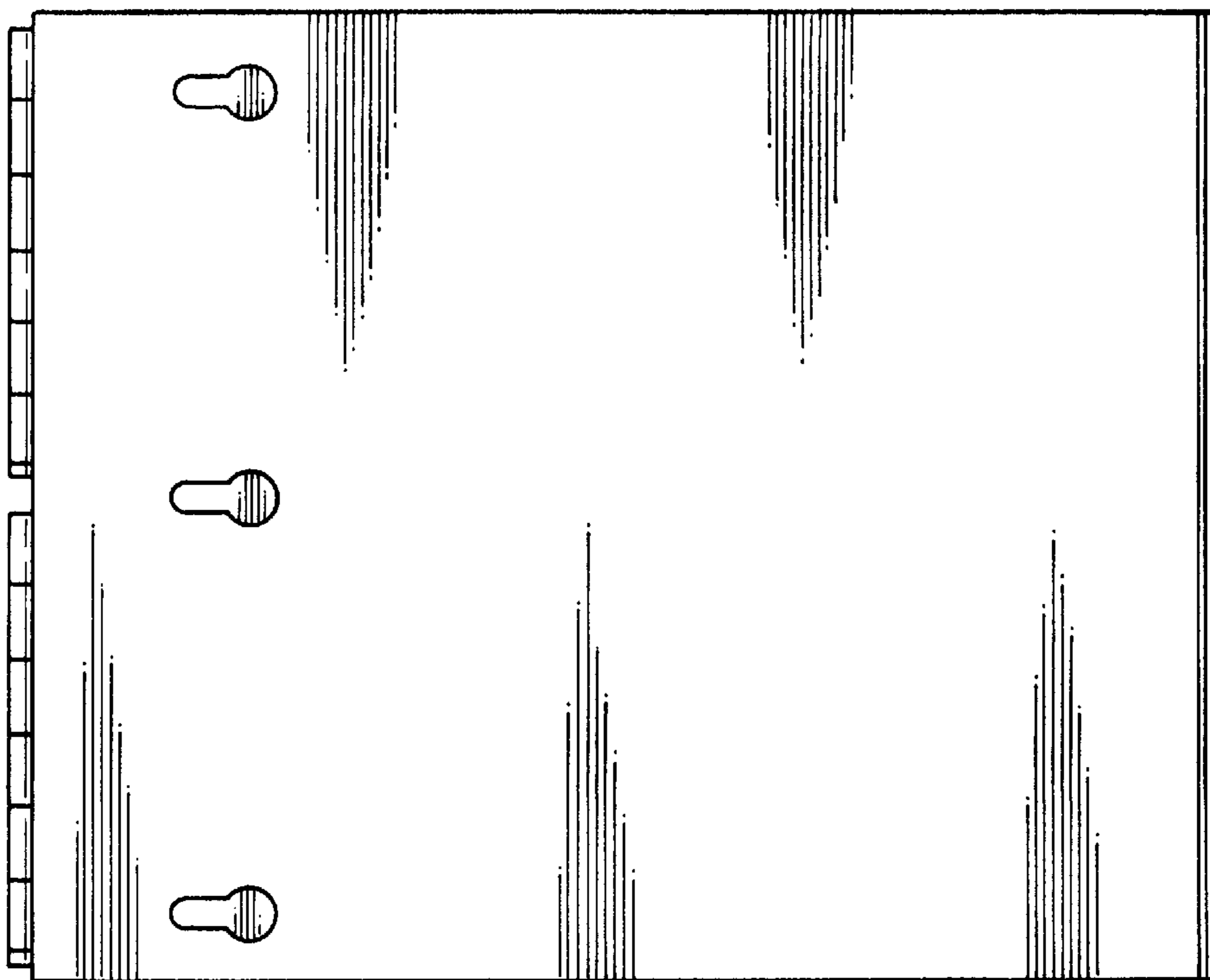
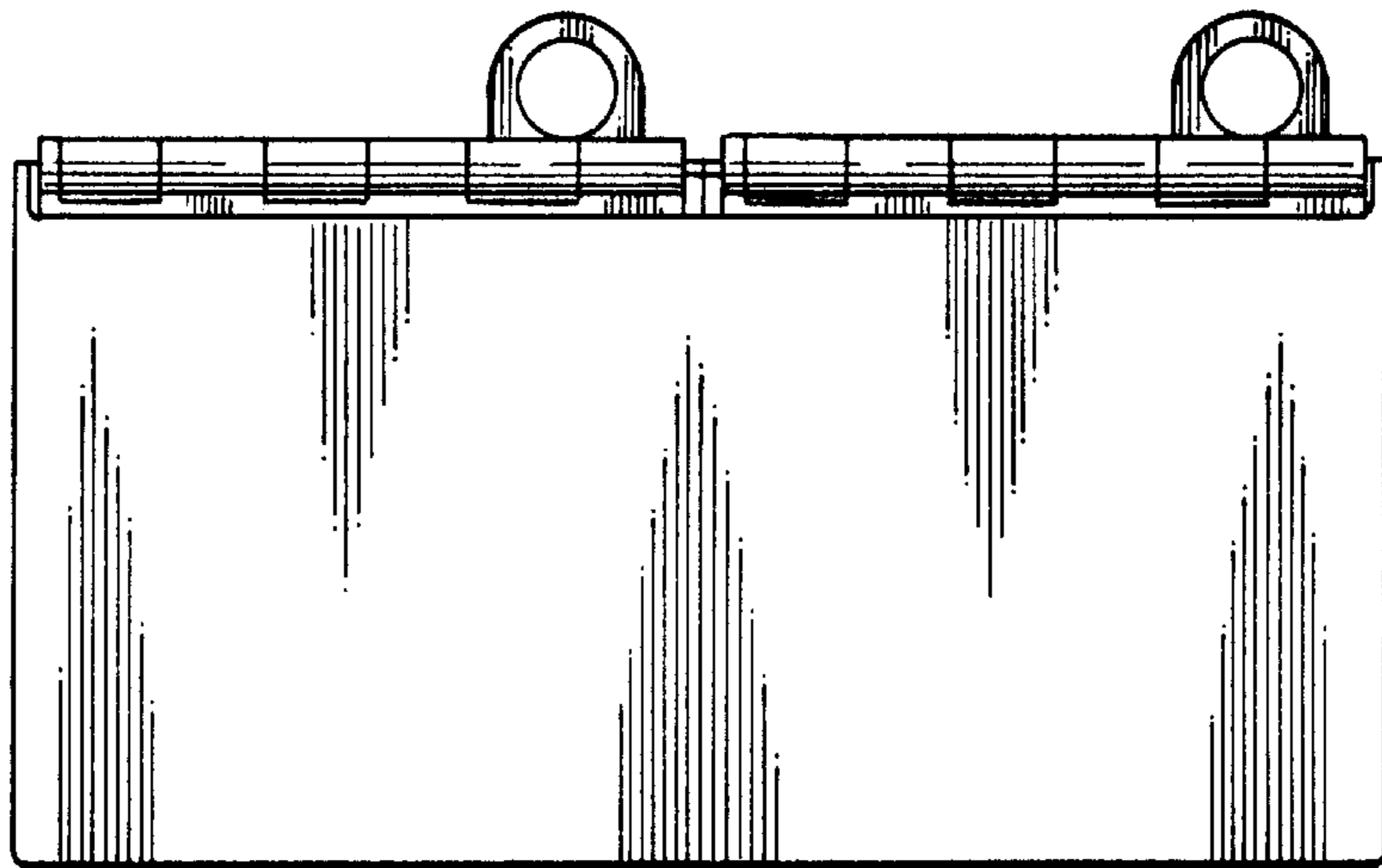

Fig. 13