



US00D410276S

United States Patent [19]
Ben-Tsur

[11] **Patent Number: Des. 410,276**

[45] **Date of Patent: ** May 25, 1999**

[54] **HAND HELD SHOWERHEAD**

D. 392,369 3/1998 Chan D23/223
D. 399,301 10/1998 Huen D23/223

[75] Inventor: **Gilad Ben-Tsur**, Kibbutz
Kfar-Hahores, Israel

Primary Examiner—Alan P. Douglas
Assistant Examiner—Robin V. Taylor
Attorney, Agent, or Firm—Myron B. Kapustij; Leon E. Redman

[73] Assignee: **Alsons Corporation**, Hillsdale, Mich.

[**] Term: **14 Years**

[57] **CLAIM**

[21] Appl. No.: **29/088,063**

The ornamental design for a hand held showerhead, as shown and described.

[22] Filed: **May 14, 1998**

DESCRIPTION

[51] **LOC (6) Cl.** **23-01**

[52] **U.S. Cl.** **D23/223**

[58] **Field of Search** D23/213, 223,
D23/226; 239/525-528, 394

FIG. 1 is a front perspective view of a hand held showerhead showing my new design;
FIG. 2 is a rear perspective view thereof;
FIG. 3 is a front elevational view thereof;
FIG. 4 is a right side elevational view thereof, the left side being a mirror image;
FIG. 5 is a top plan view thereof;
FIG. 6 is a bottom plan view thereof; and,
FIG. 7 is a rear elevational view thereof.

[56] **References Cited**

U.S. PATENT DOCUMENTS

- D. 352,347 11/1994 Dannenberg D23/223
- D. 369,205 4/1996 Andrus D23/223
- D. 374,477 10/1996 Dow et al. D23/223
- D. 385,947 11/1997 Dow et al. D23/223

1 Claim, 2 Drawing Sheets

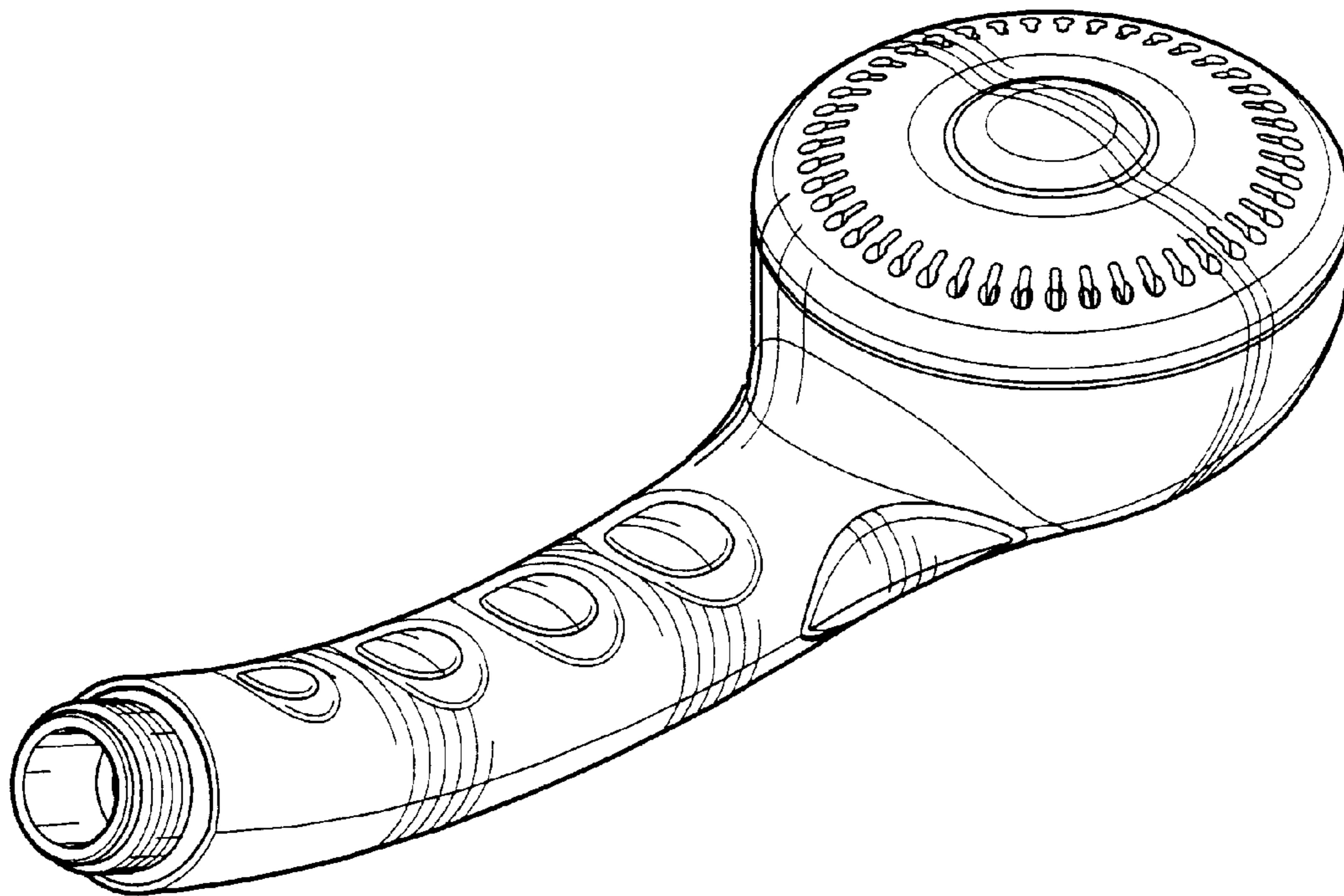

Fig-1

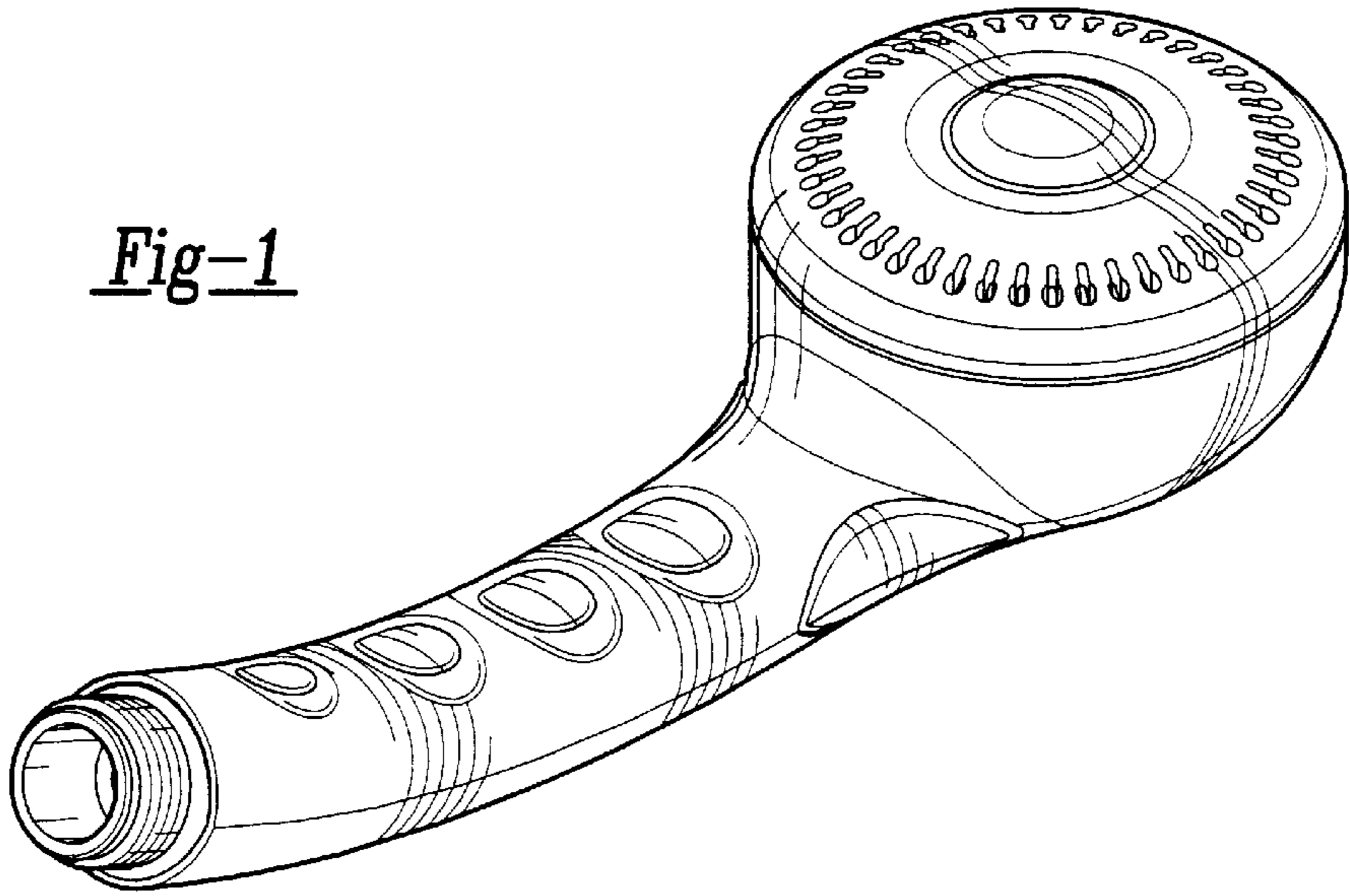

Fig-2

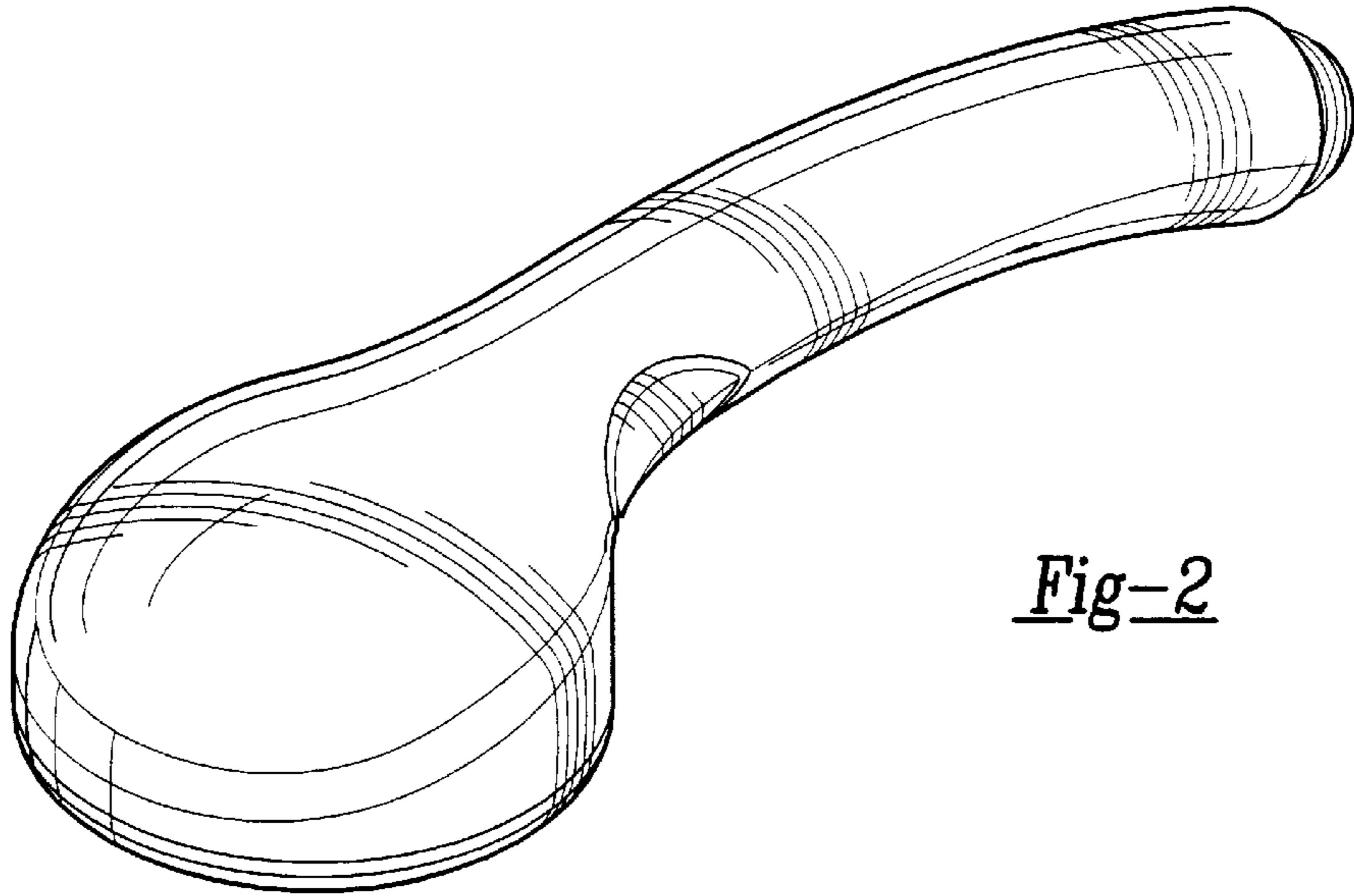
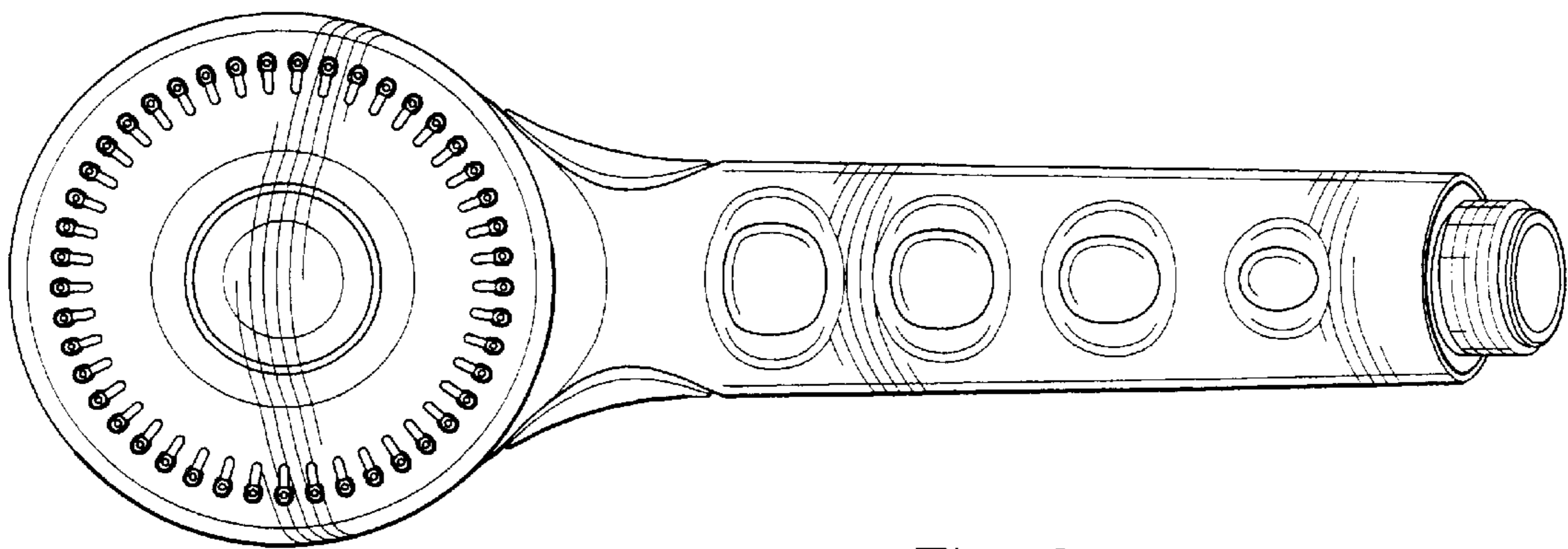

Fig-3



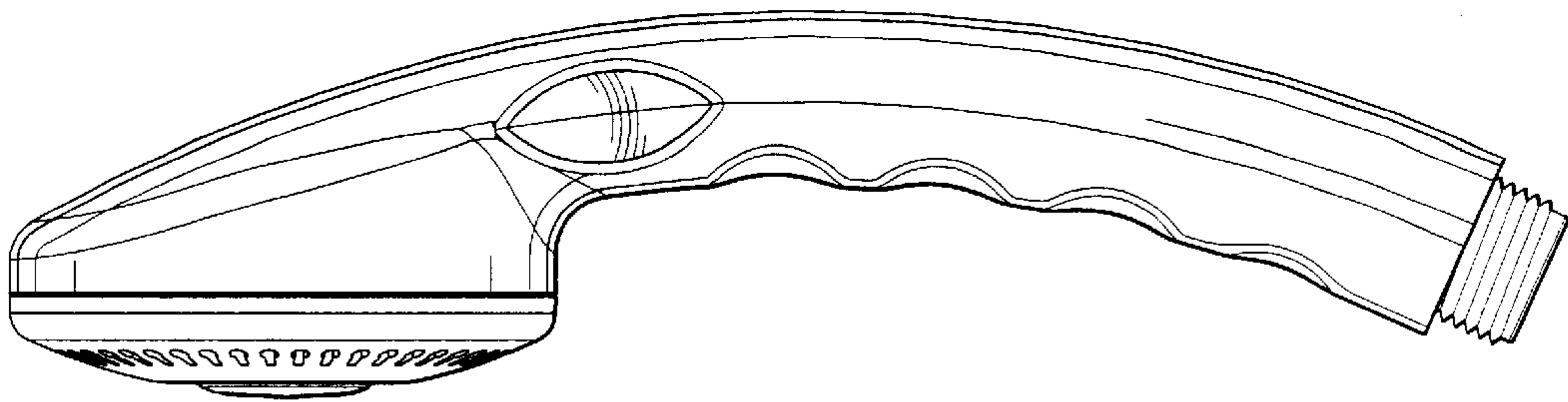

Fig-4

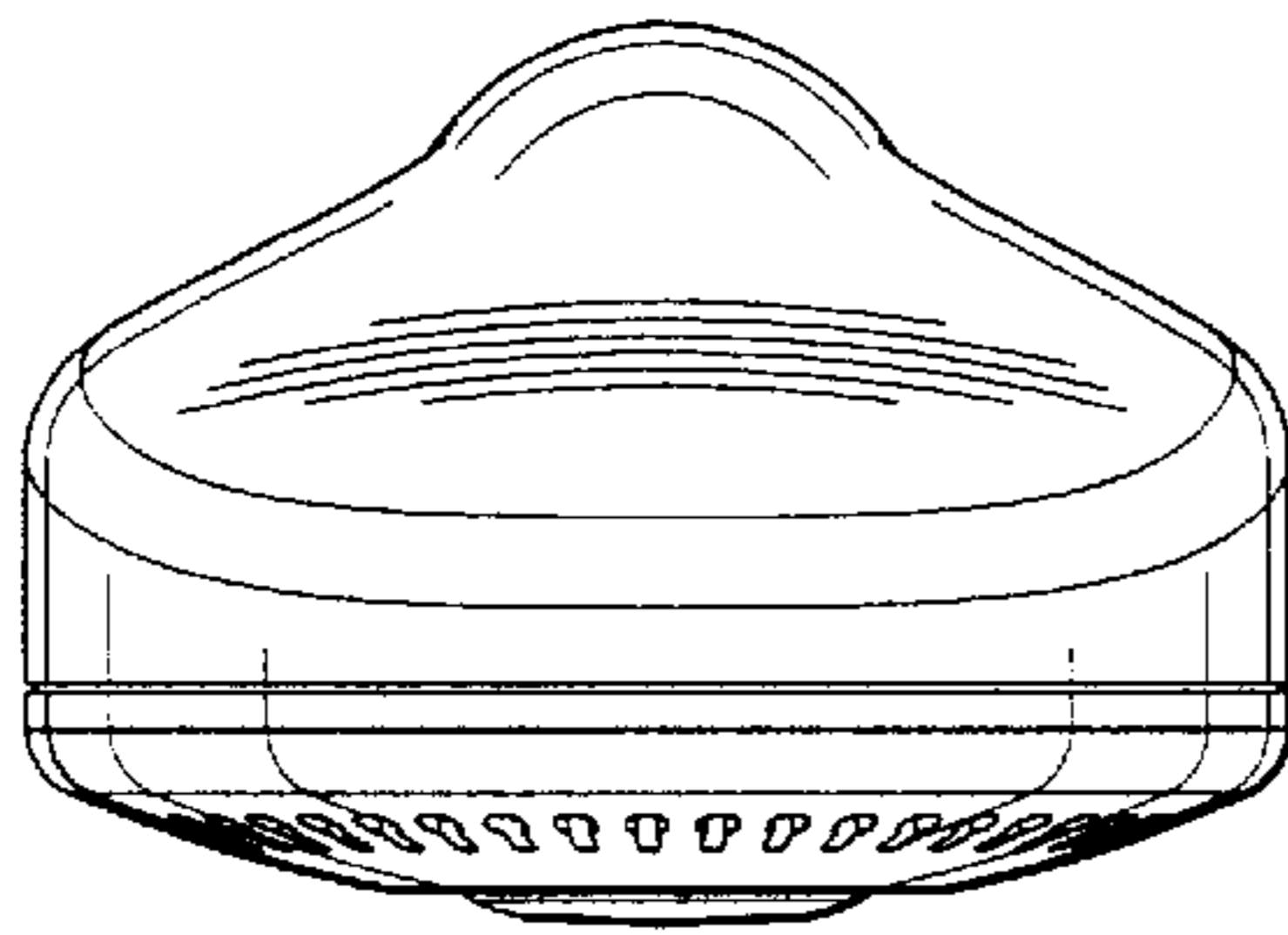

Fig-5

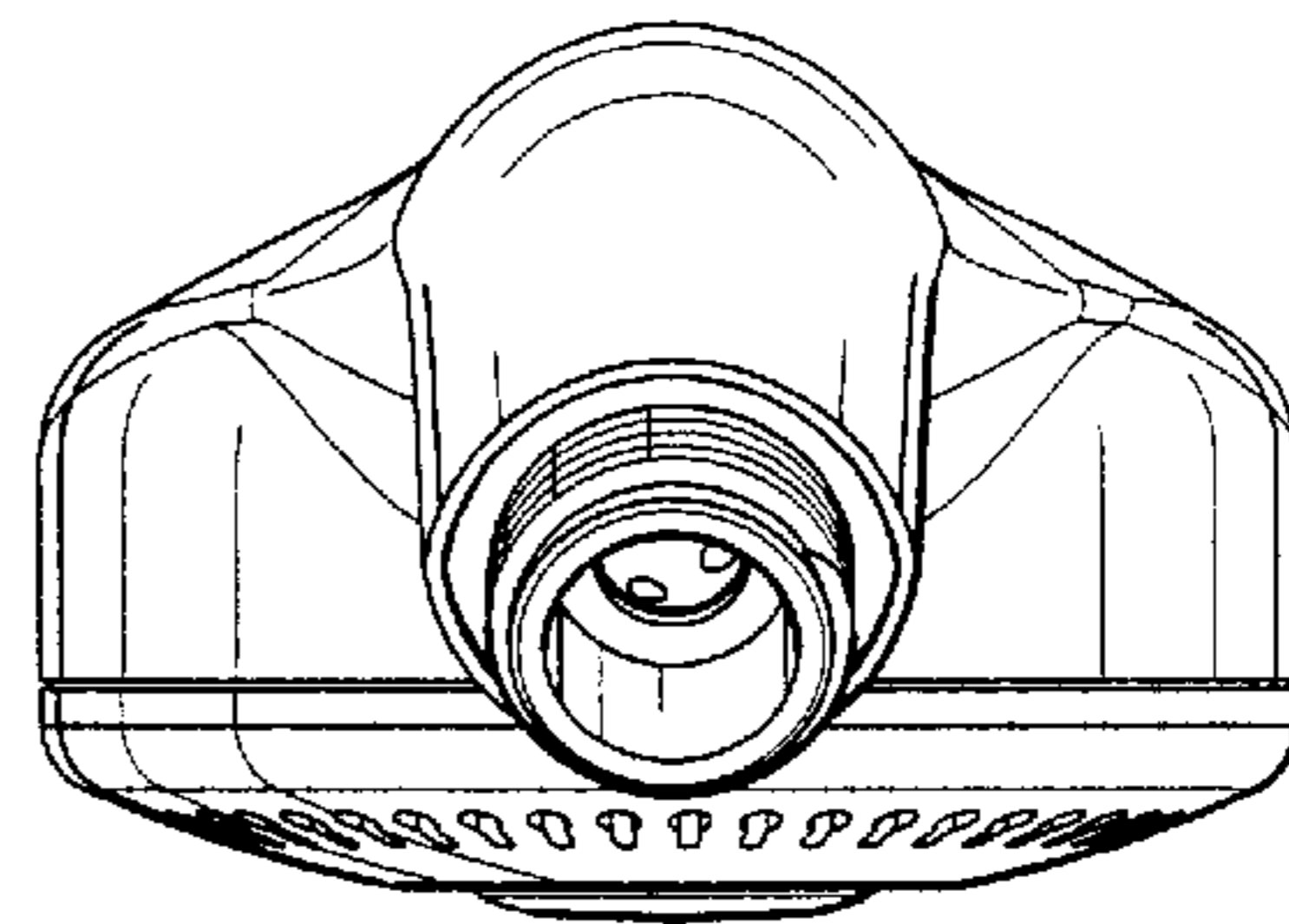

Fig-6

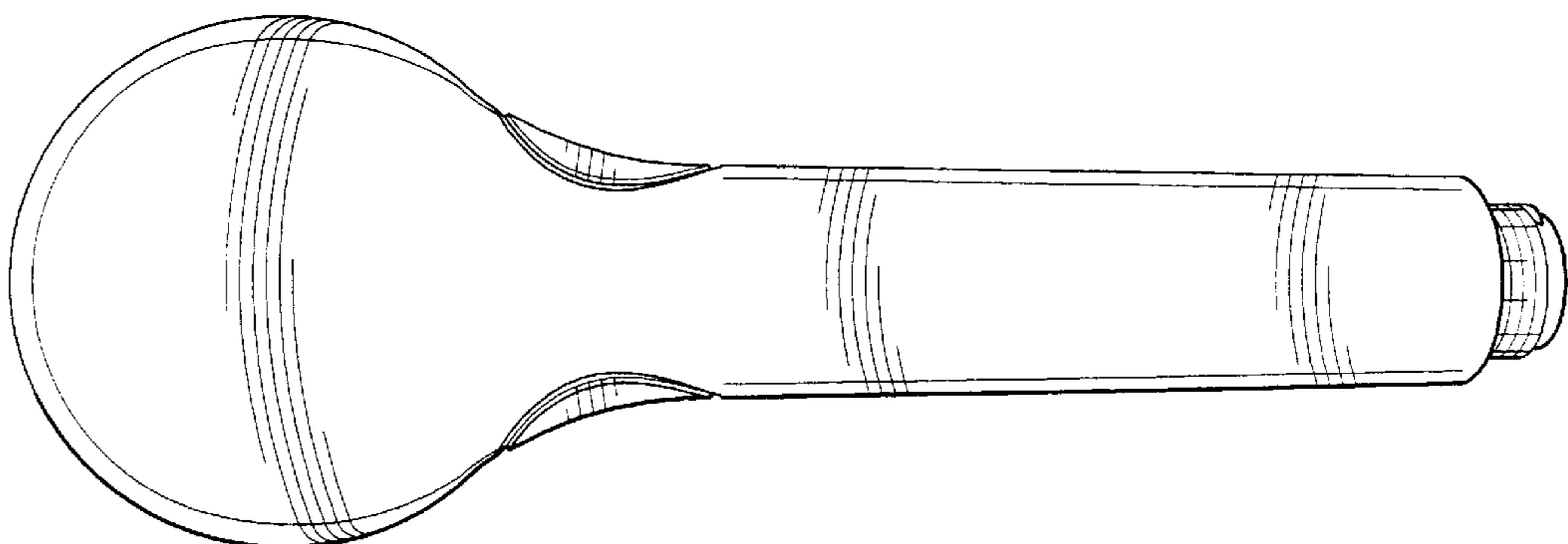

Fig-7