



US00D410271S

United States Patent [19] Manus

[11] **Patent Number: Des. 410,271**

[45] **Date of Patent: ** May 25, 1999**

[54] **PLAYGROUND CLIMBER**

[76] Inventor: **Ray G. Manus**, 2028½ Eaker Dr.,
Cherryville, N.C. 28021

[**] Term: **14 Years**

[21] Appl. No.: **07/509,617**

[22] Filed: **Apr. 16, 1990**

[51] **LOC (6) Cl.** **21-03**

[52] **U.S. Cl.** **D21/826**

[58] **Field of Search** D21/244, 245,
D21/240; 472/2; 482/35, 36, 37, 148

[56] **References Cited**

U.S. PATENT DOCUMENTS

1,471,465	10/1923	Hinton	D21/245	X
3,211,452	10/1965	Ahrens	482/35	
3,730,520	5/1973	Willis	D21/245	X
3,850,428	11/1974	Zuber	482/36	
4,580,777	4/1986	Johnson	D21/245	X
4,627,612	12/1986	Gehlbach	482/36	

FOREIGN PATENT DOCUMENTS

2026417	12/1971	Germany	482/35	
1405885	9/1975	United Kingdom	482/35	

OTHER PUBLICATIONS

The Mexico Forge Inc. 1968 Catalog, p. 11 Climber #640-000, top right of the page.
Popular Science, Jul. 1982, p. 88.
Popular Science, Jul. 1982, p. 96.

Primary Examiner—Prabhakar G. Deshmukh

[57] **CLAIM**

The ornamental design for a playground climber, as shown and described.

DESCRIPTION

FIG. 1 is a perspective view of a playground climber showing my new design;
FIG. 2 is a top plan view thereof;
FIG. 3 is a side elevational view thereof; either side elevational view being a mirror image of the other;
FIG. 4 is a front elevational view thereof; the rear elevational view being a mirror image thereof;
FIG. 5 is a perspective view of a second embodiment of FIG. 1;
FIG. 6 is a top plan view of FIG. 5;
FIG. 7 is a front elevational view of FIG. 5;
FIG. 8 is a left side elevational view of FIG. 5; the right side elevational view being a mirror image thereof;
FIG. 9 is a perspective view of a third embodiment of FIG. 1;
FIG. 10 is a top plan view of FIG. 9;
FIG. 11 is a right side elevational view of FIG. 9;
FIG. 12 is a left side elevational view of FIG. 9;
FIG. 13 is a perspective view of a fourth embodiment of FIG. 1;
FIG. 14 is a top plan view of FIG. 13;
FIG. 15 is a front elevational view of FIG. 13;
FIG. 16 is a left side elevational view of FIG. 13; the right side elevational view being a mirror image thereof;
FIG. 17 is a perspective view of a fifth embodiment of FIG. 1;
FIG. 18 is a top plan view of FIG. 17; and,
FIG. 19 is a right side elevational view of FIG. 17; the left side being a mirror image thereof.

1 Claim, 19 Drawing Sheets

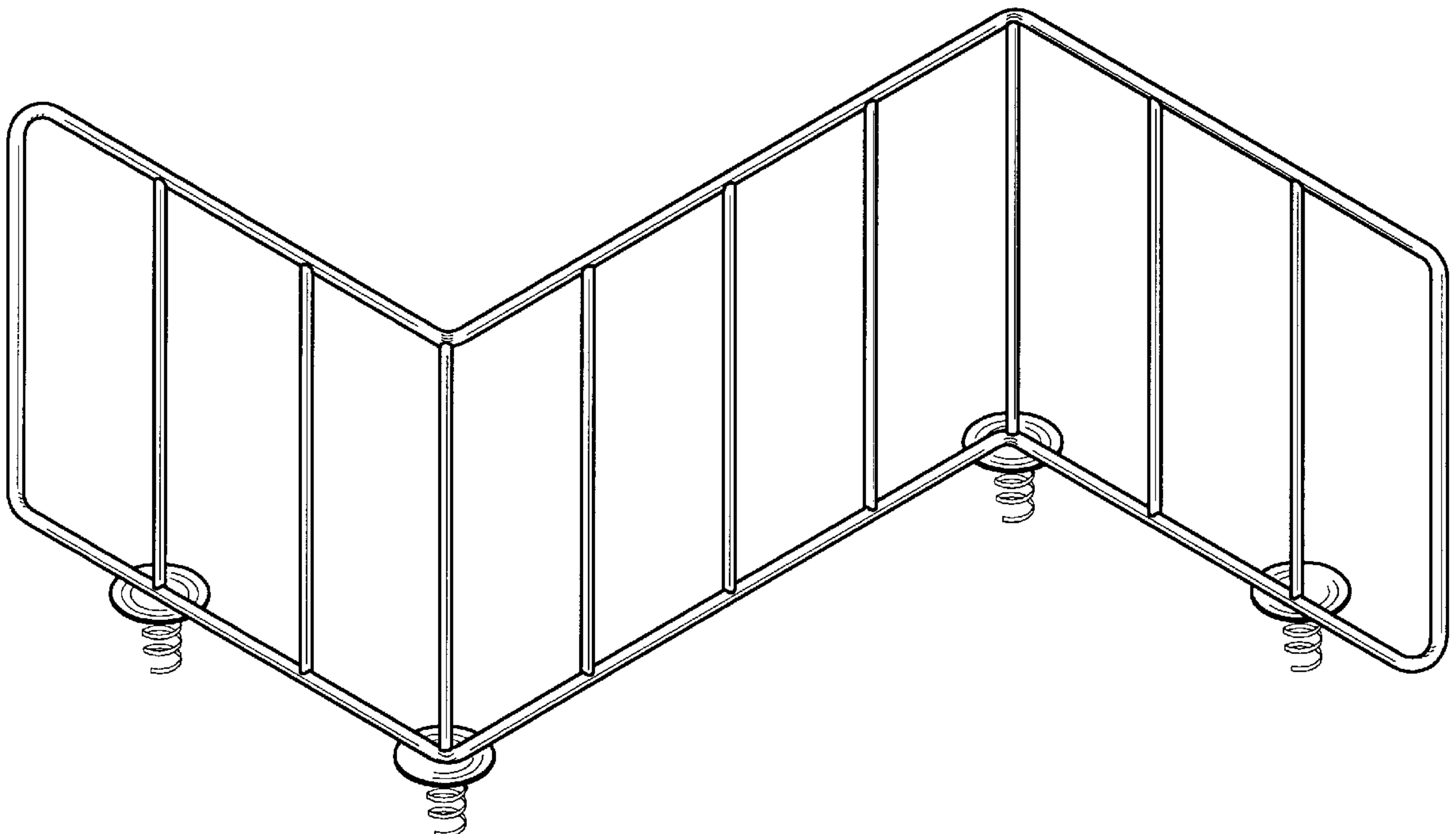

FIG. 1

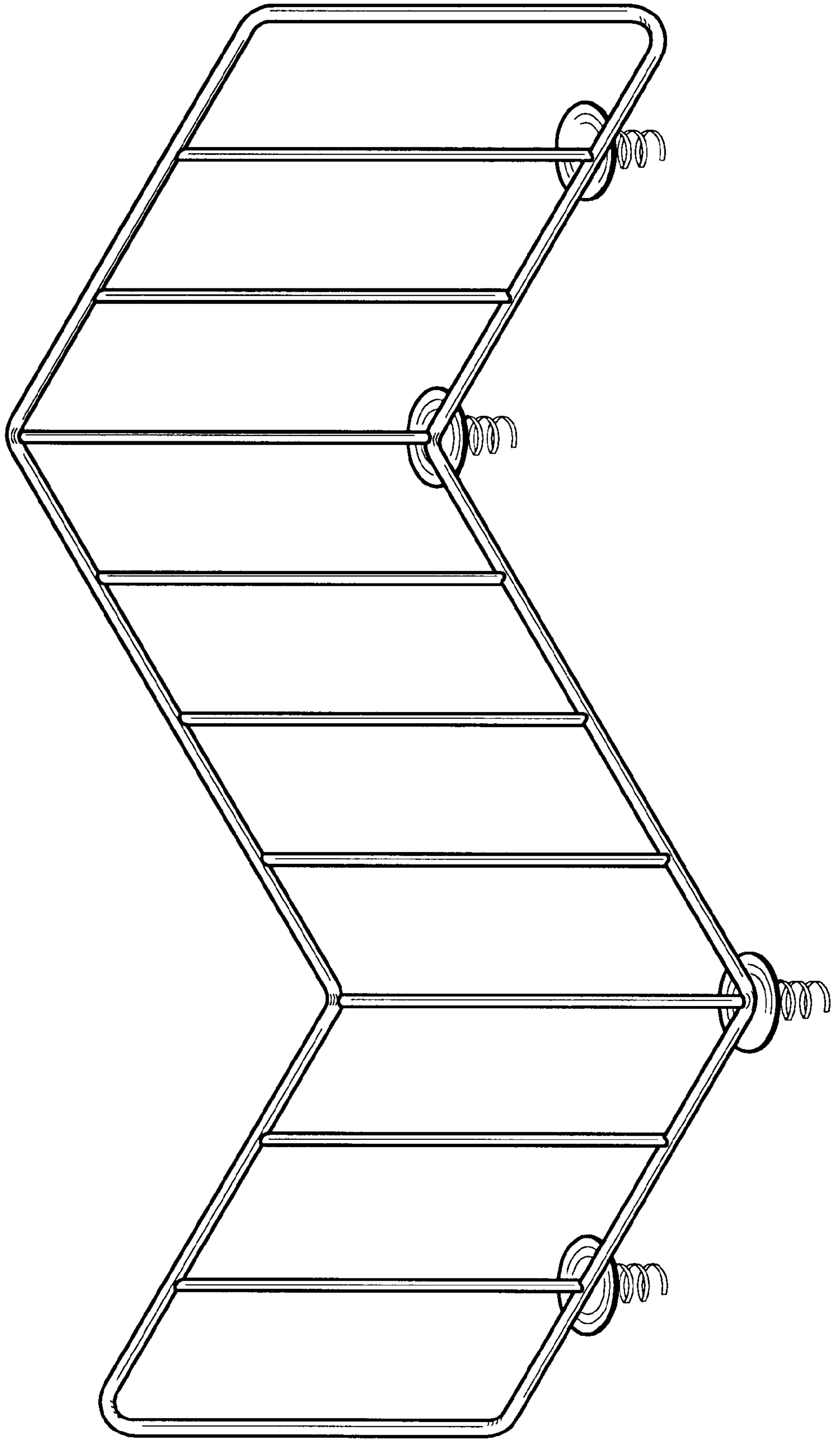

FIG. 2

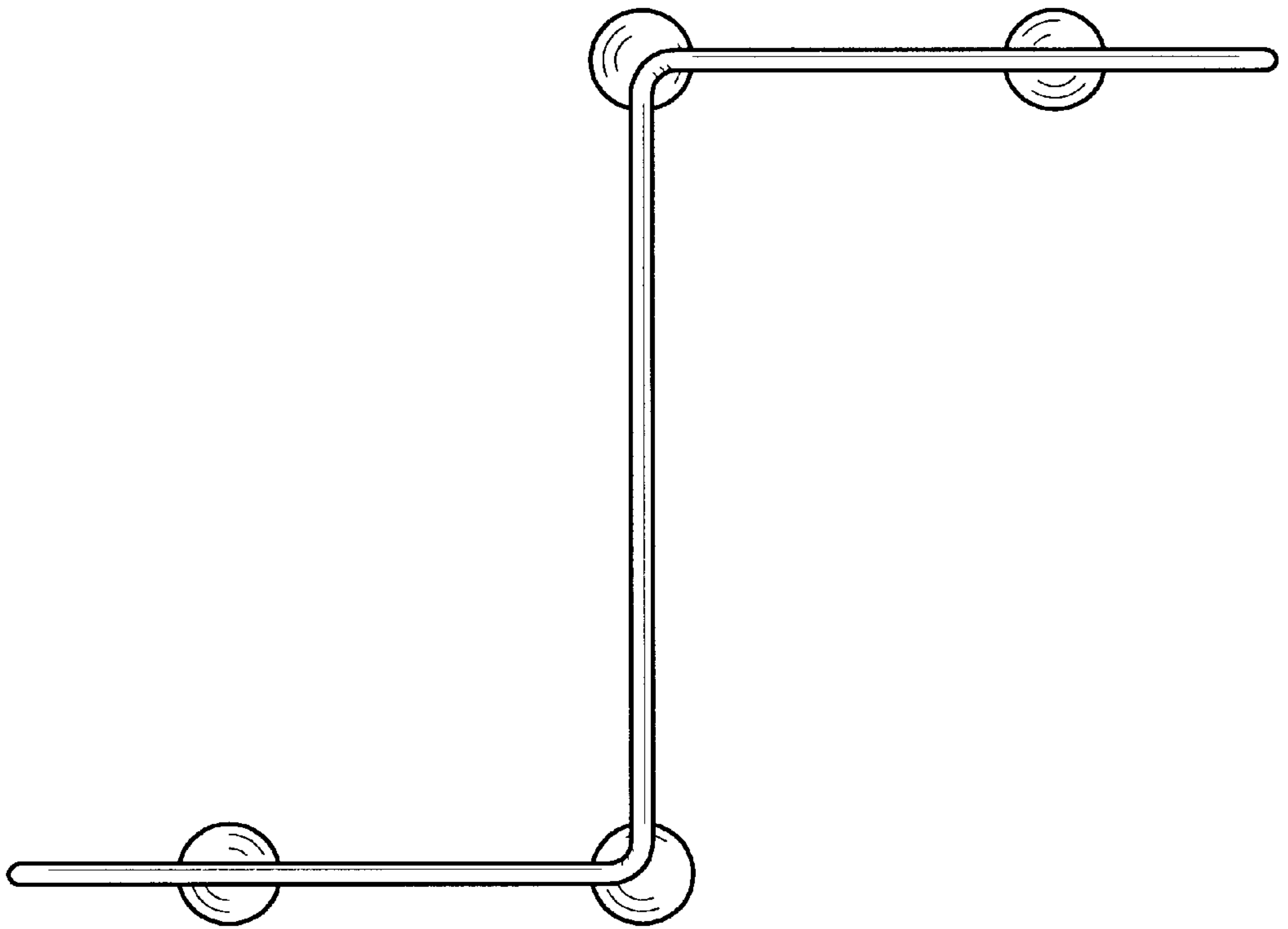

FIG. 3

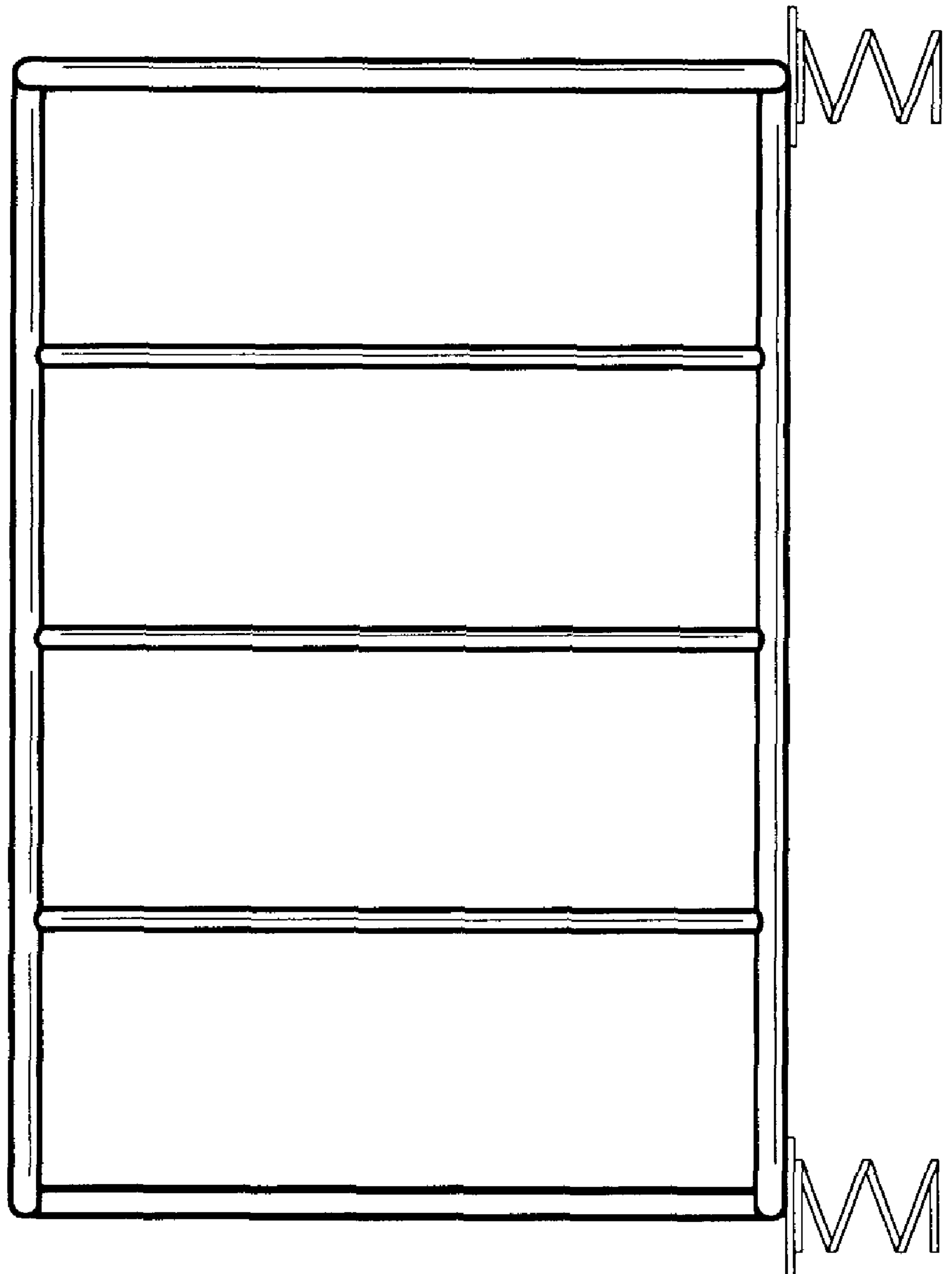

FIG. 4

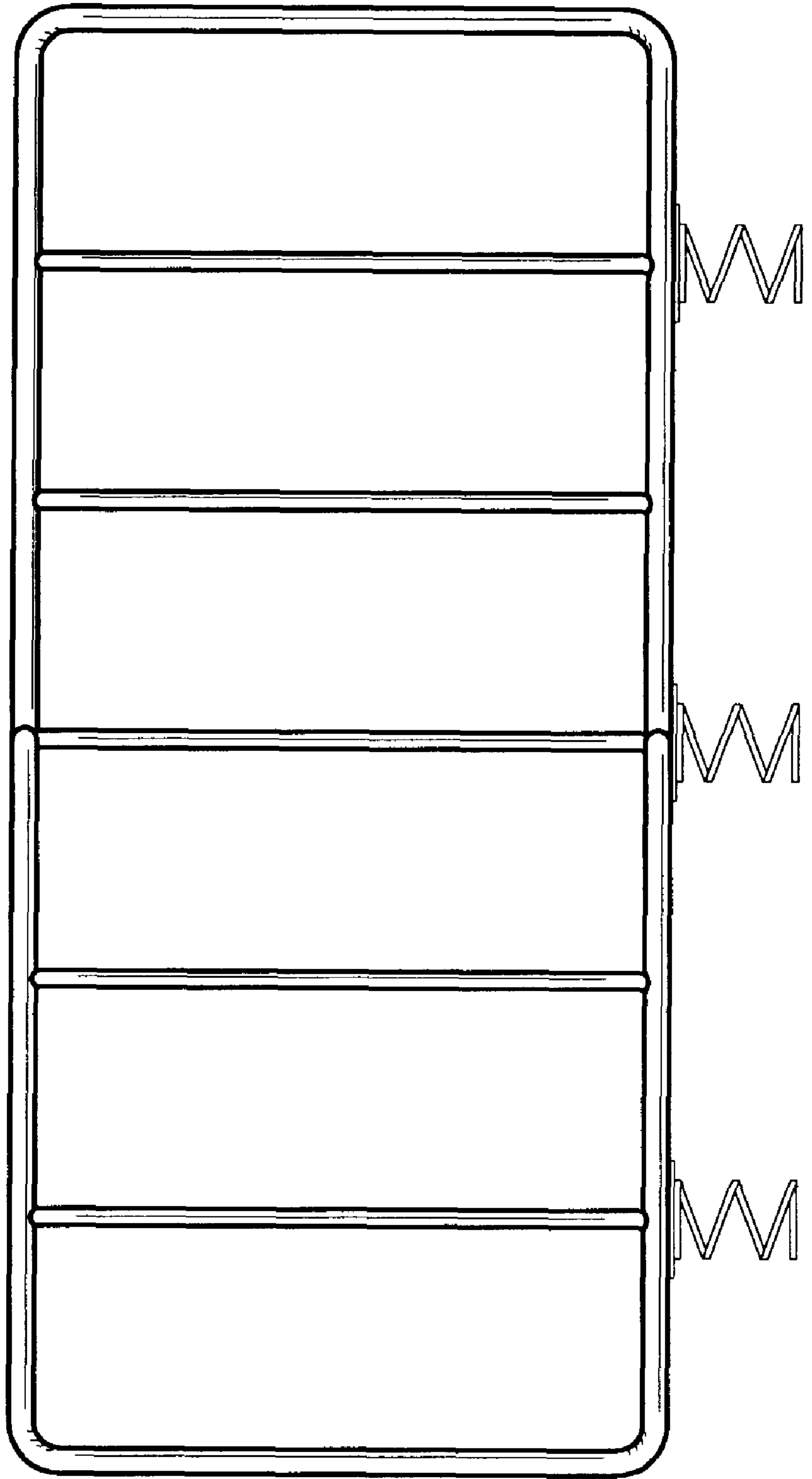

FIG. 5

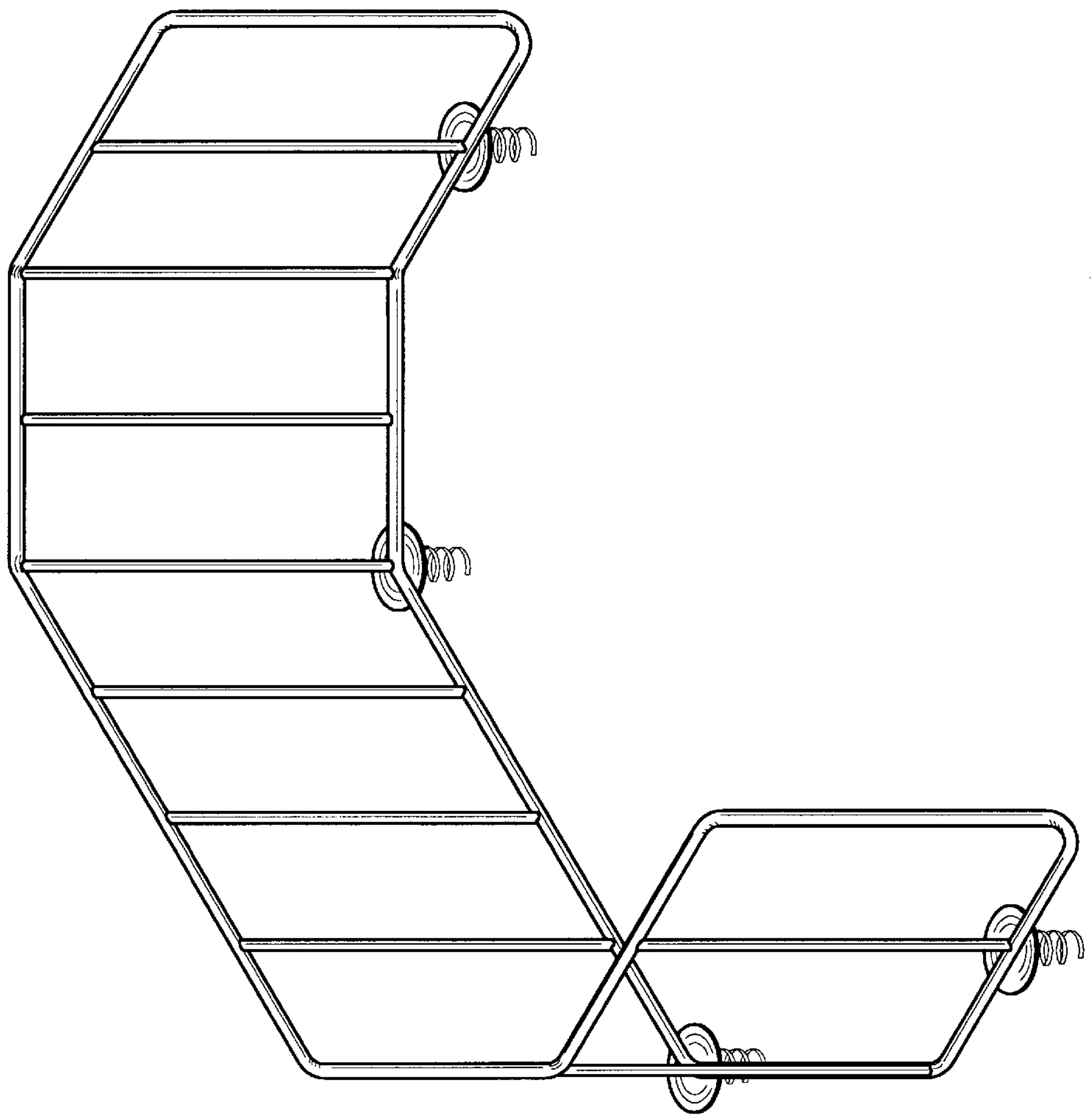

FIG. 6

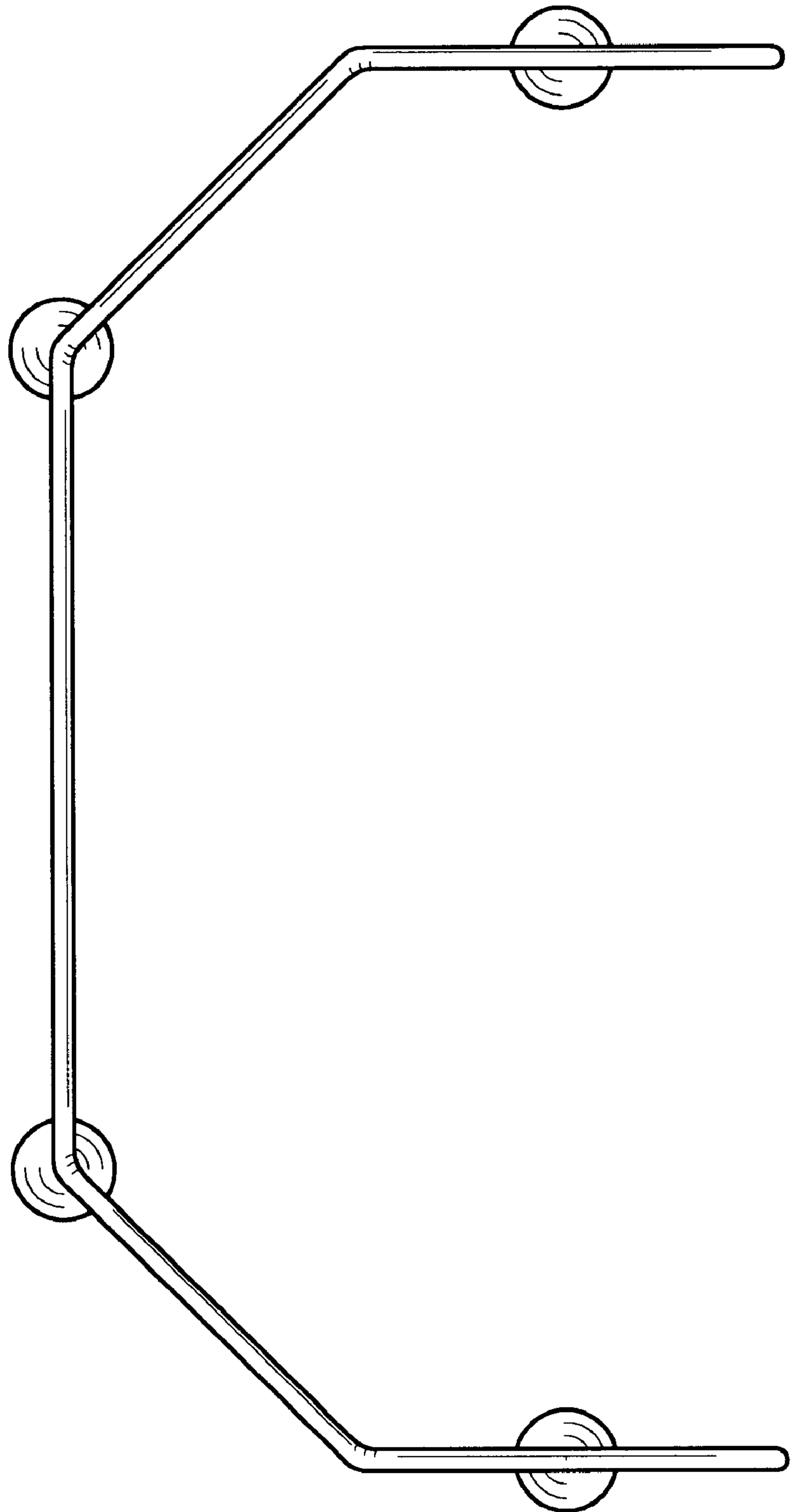

FIG. 7

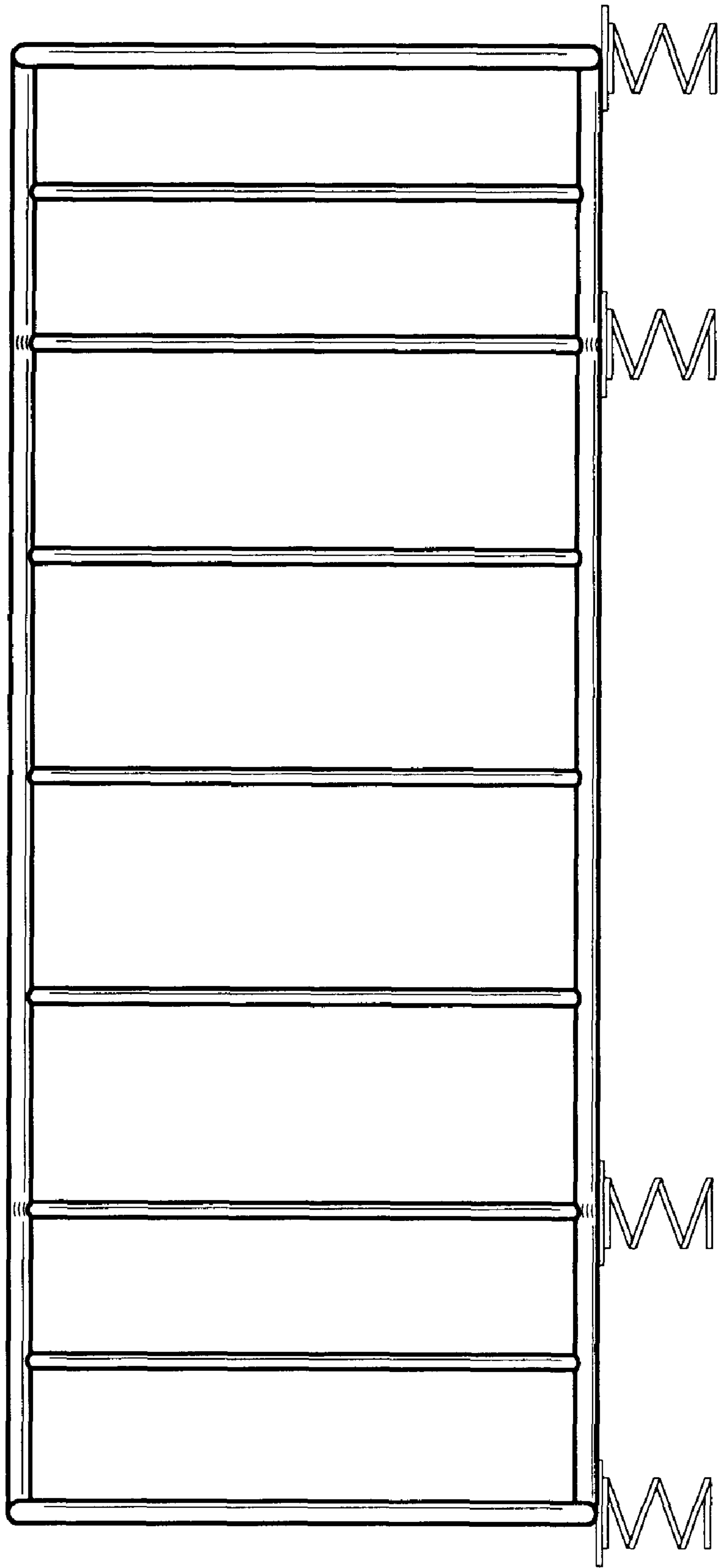

FIG. 8

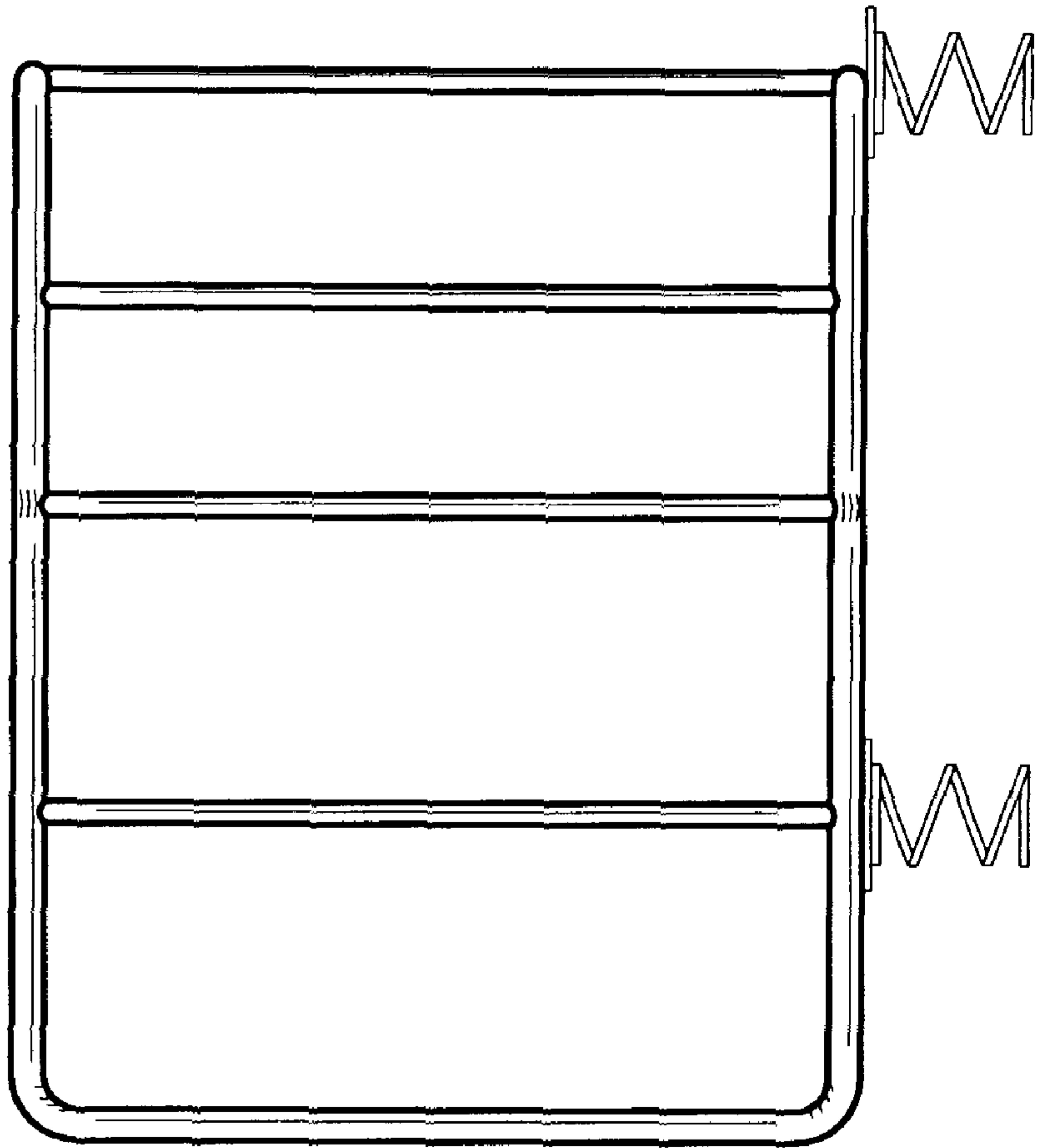

FIG. 9

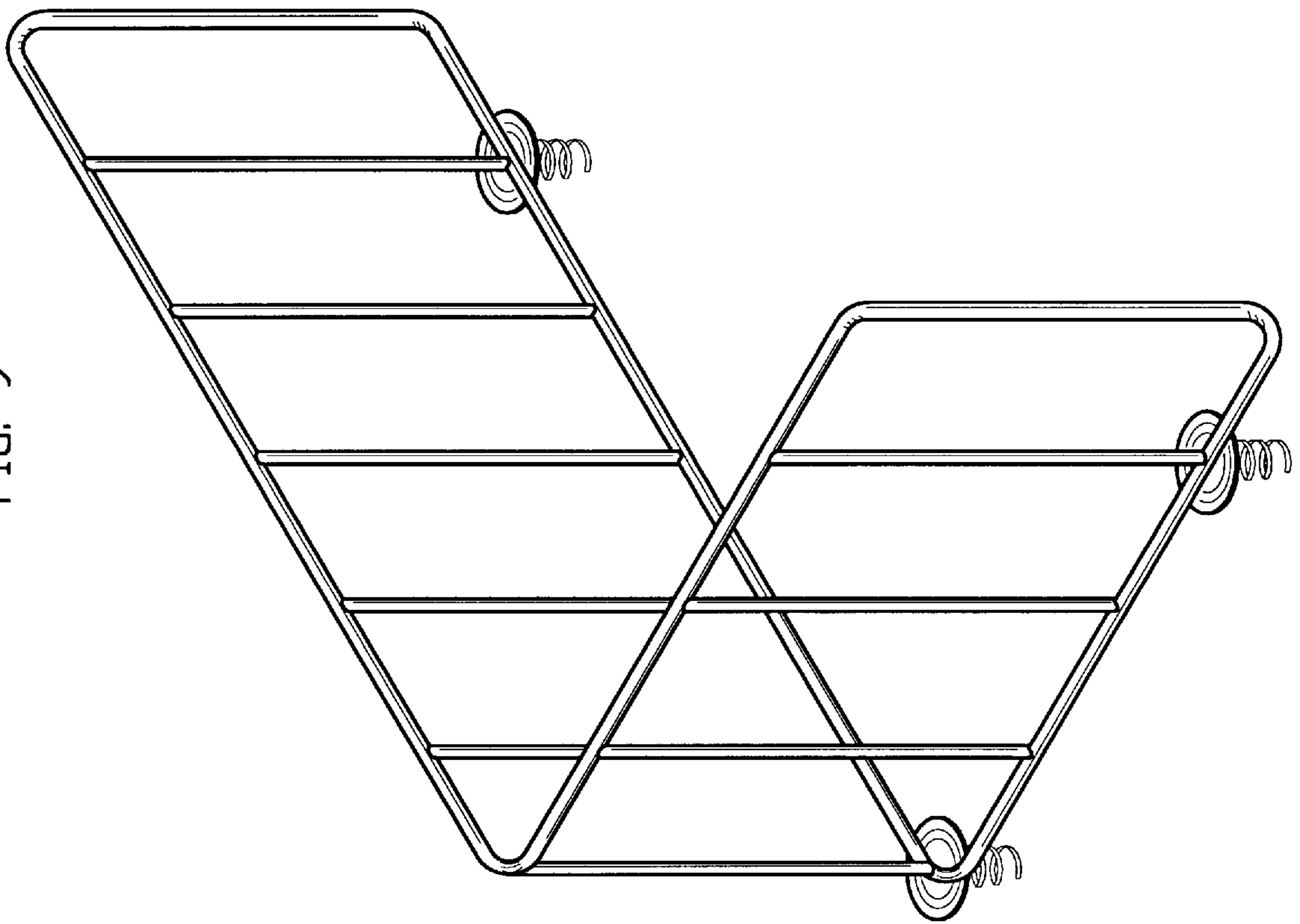

FIG. 10

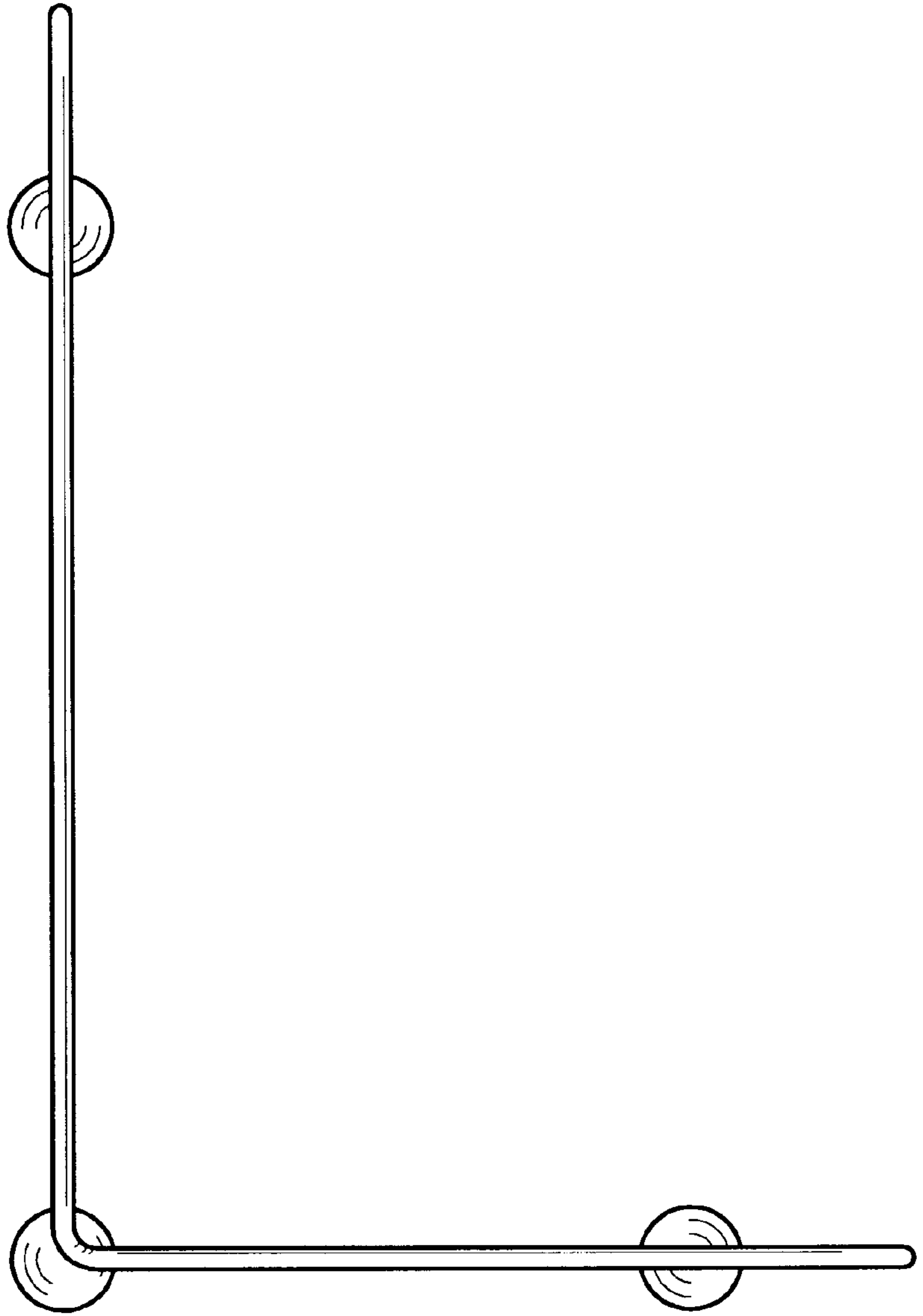

FIG. 11

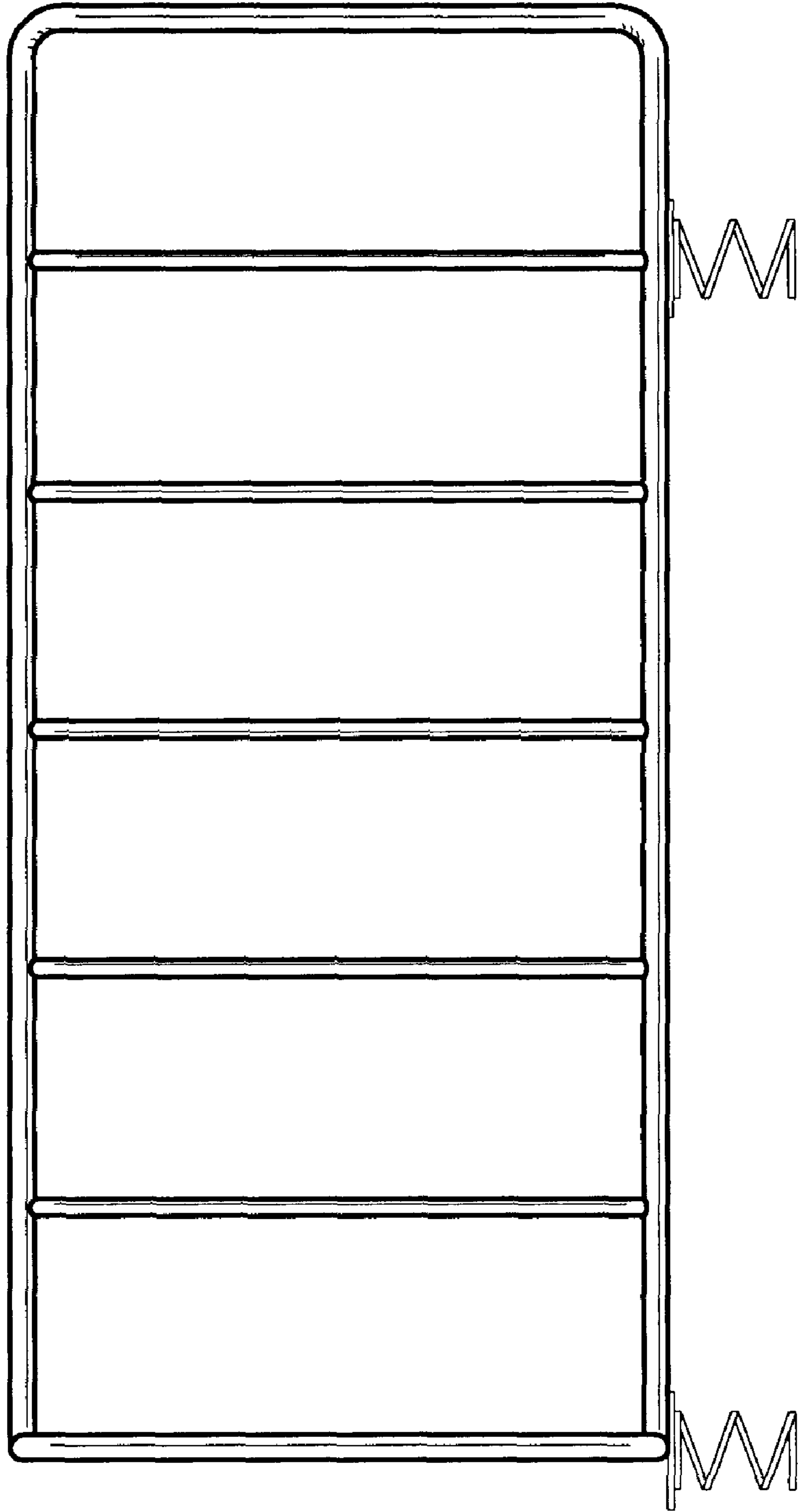

FIG. 12

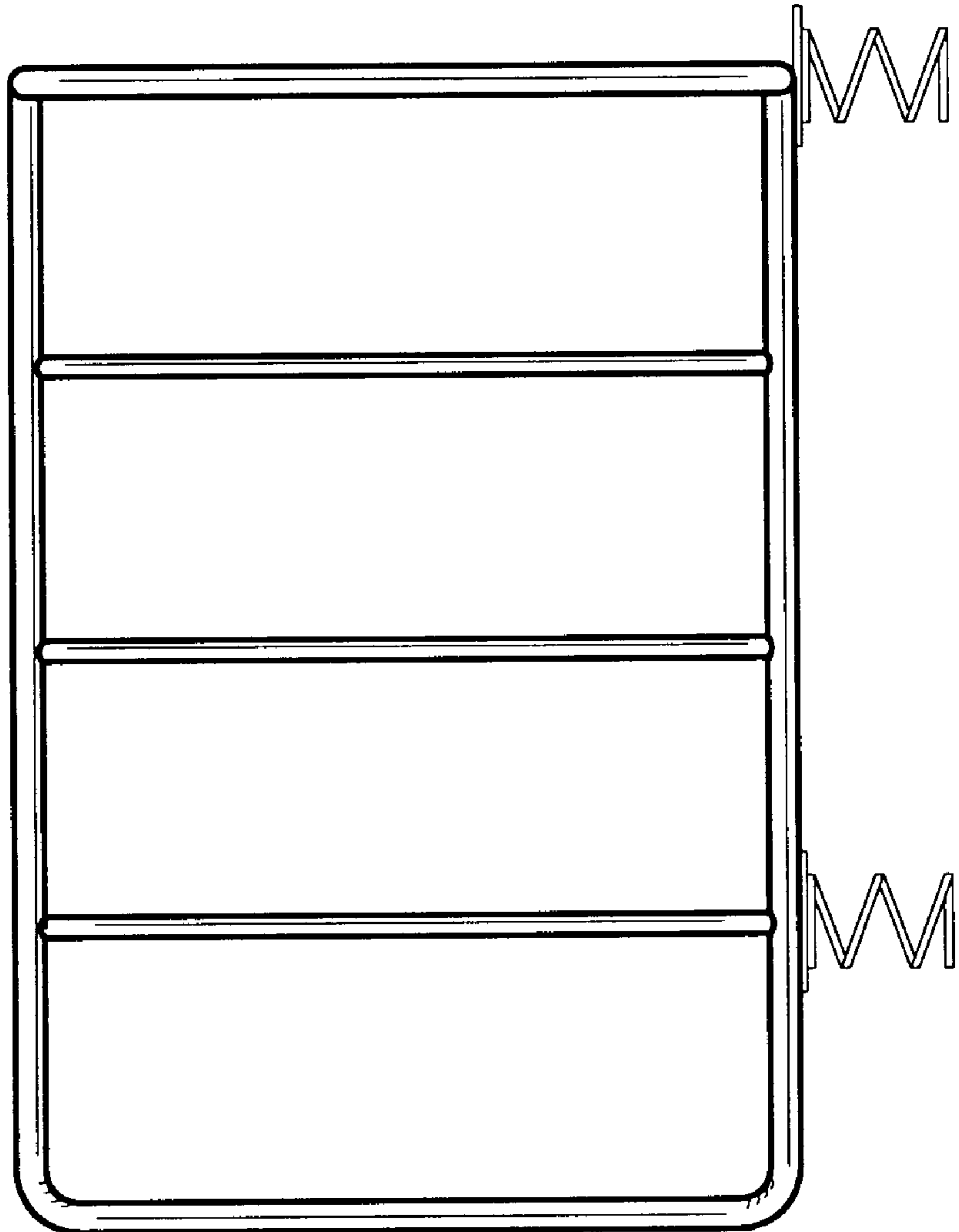

FIG. 13

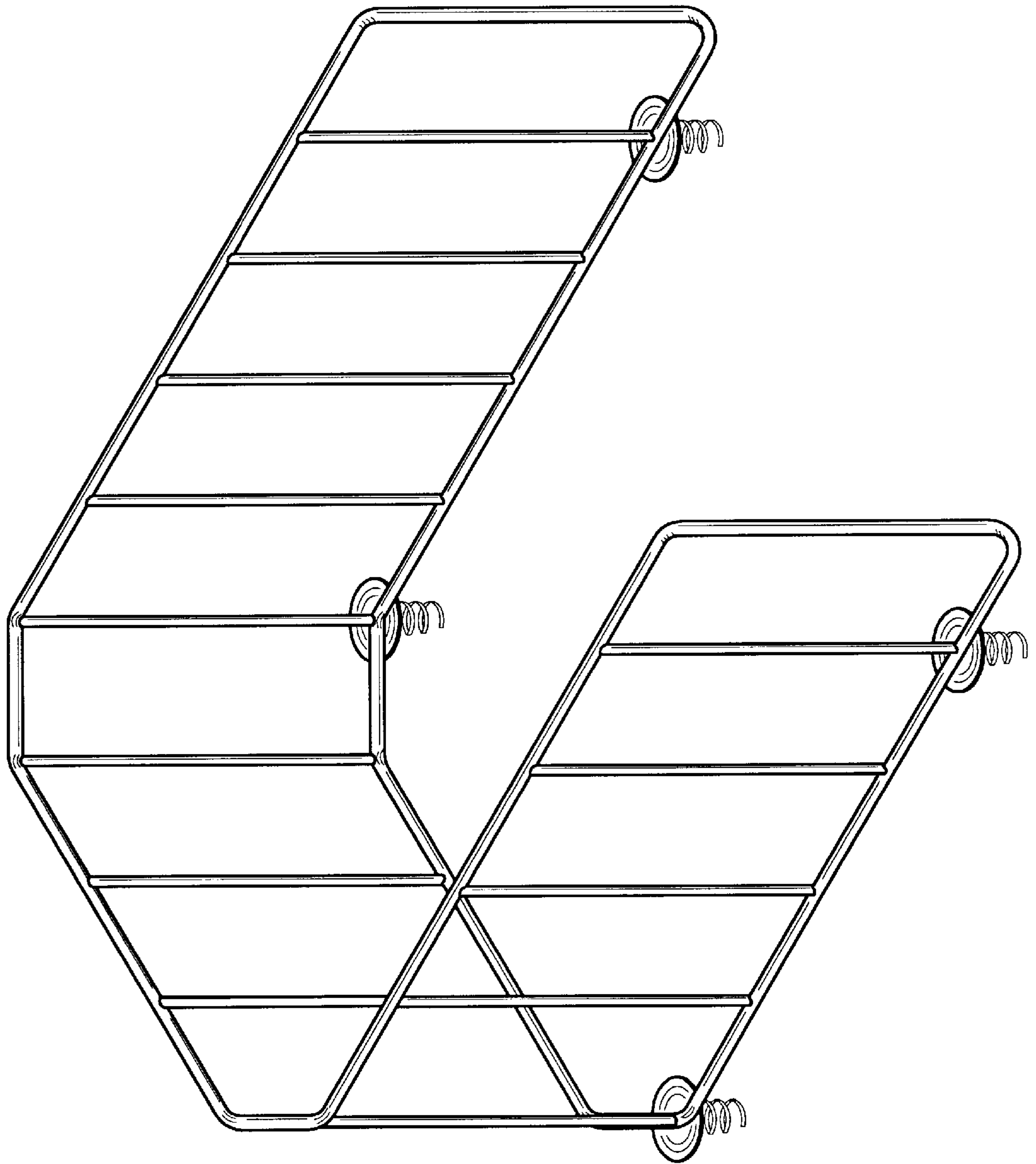

FIG. 14

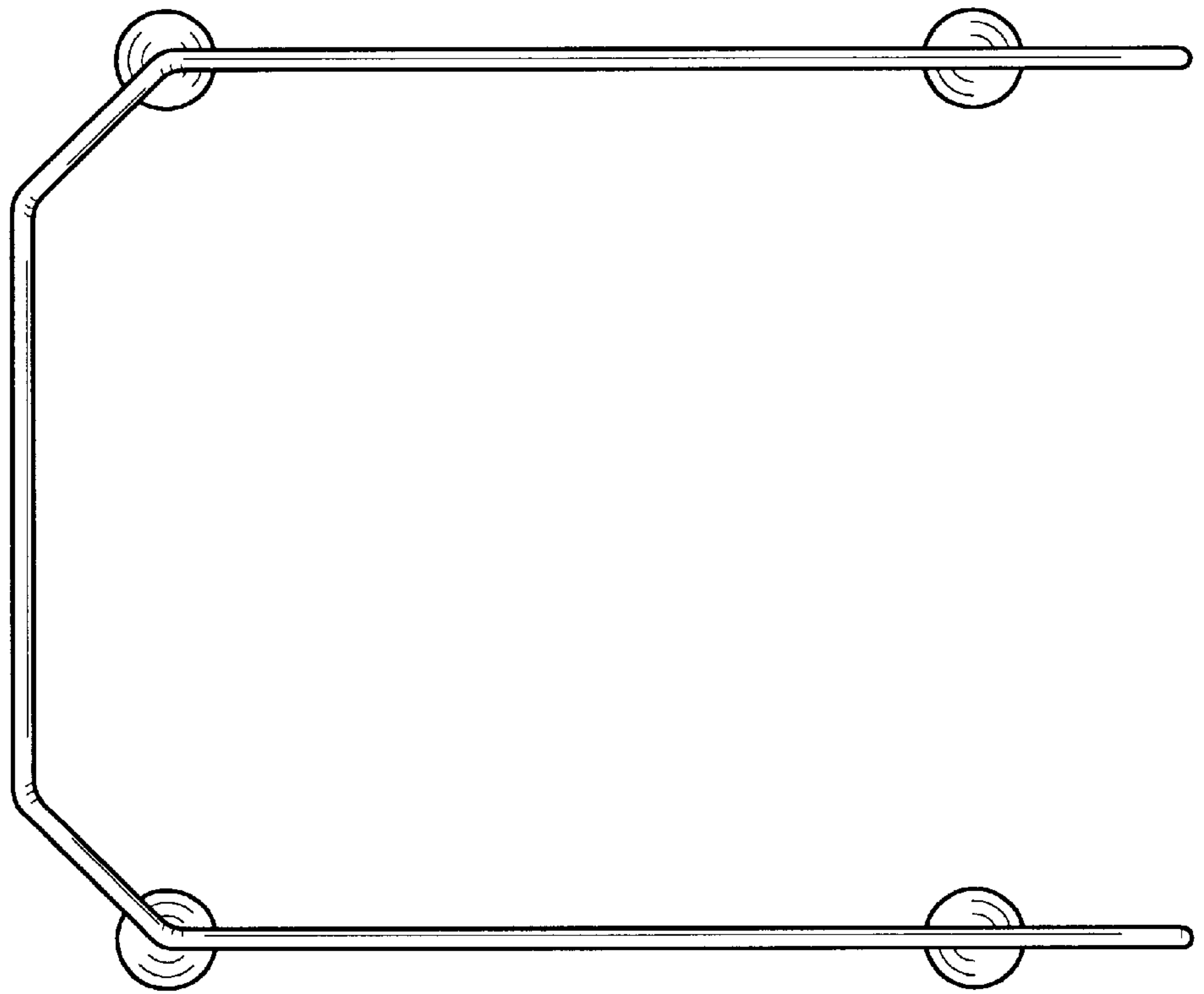

FIG. 15

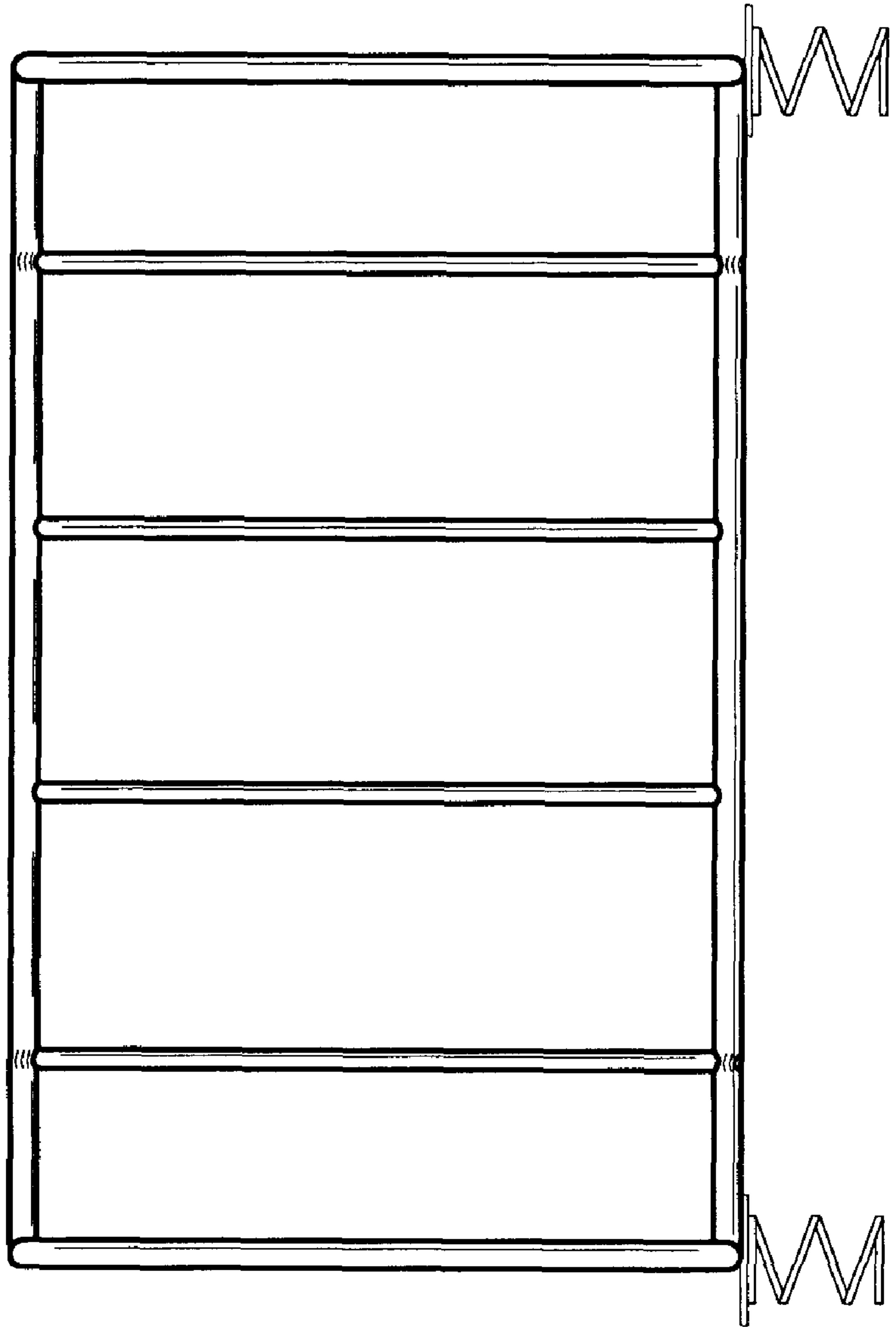
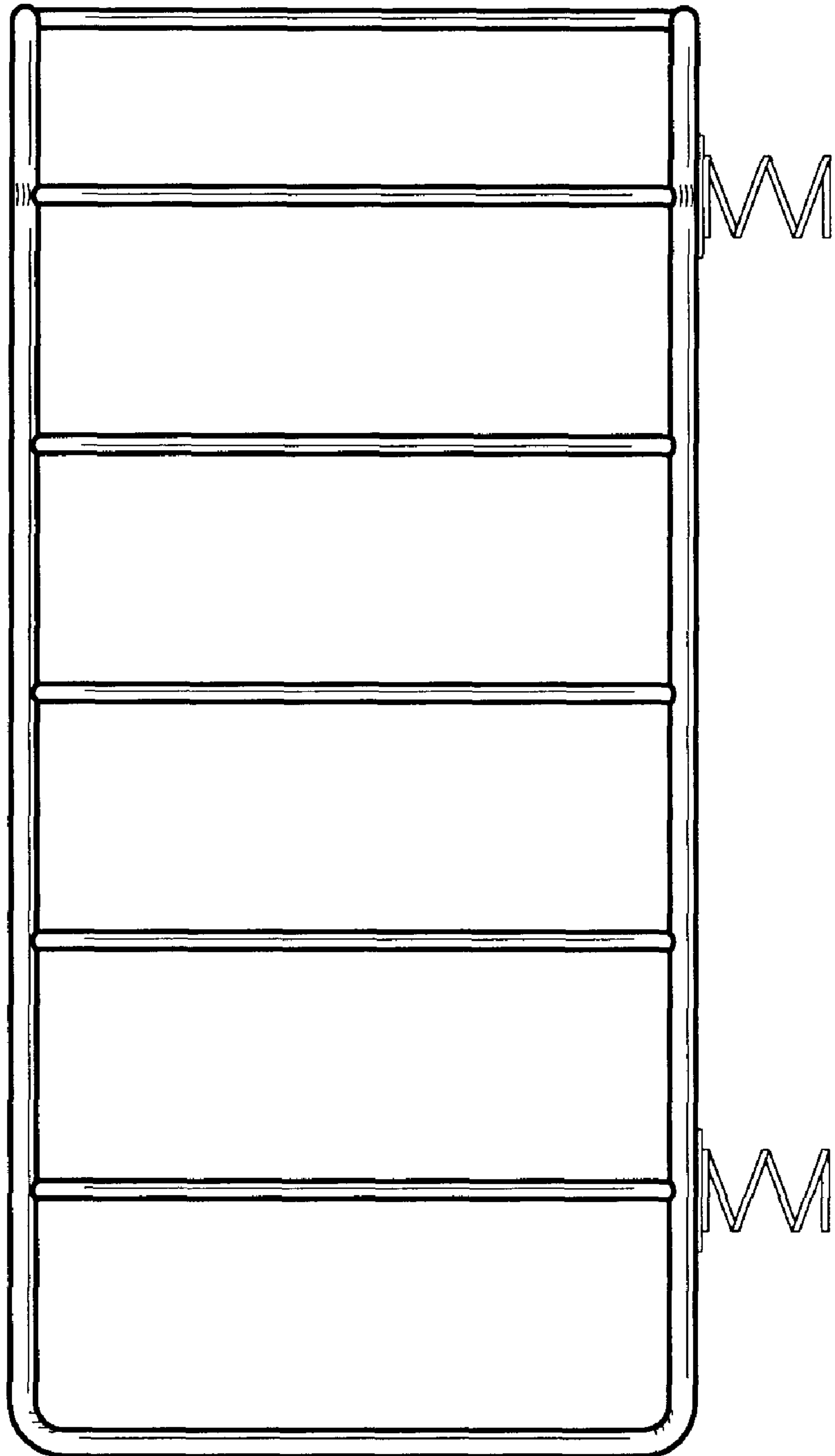

FIG. 16



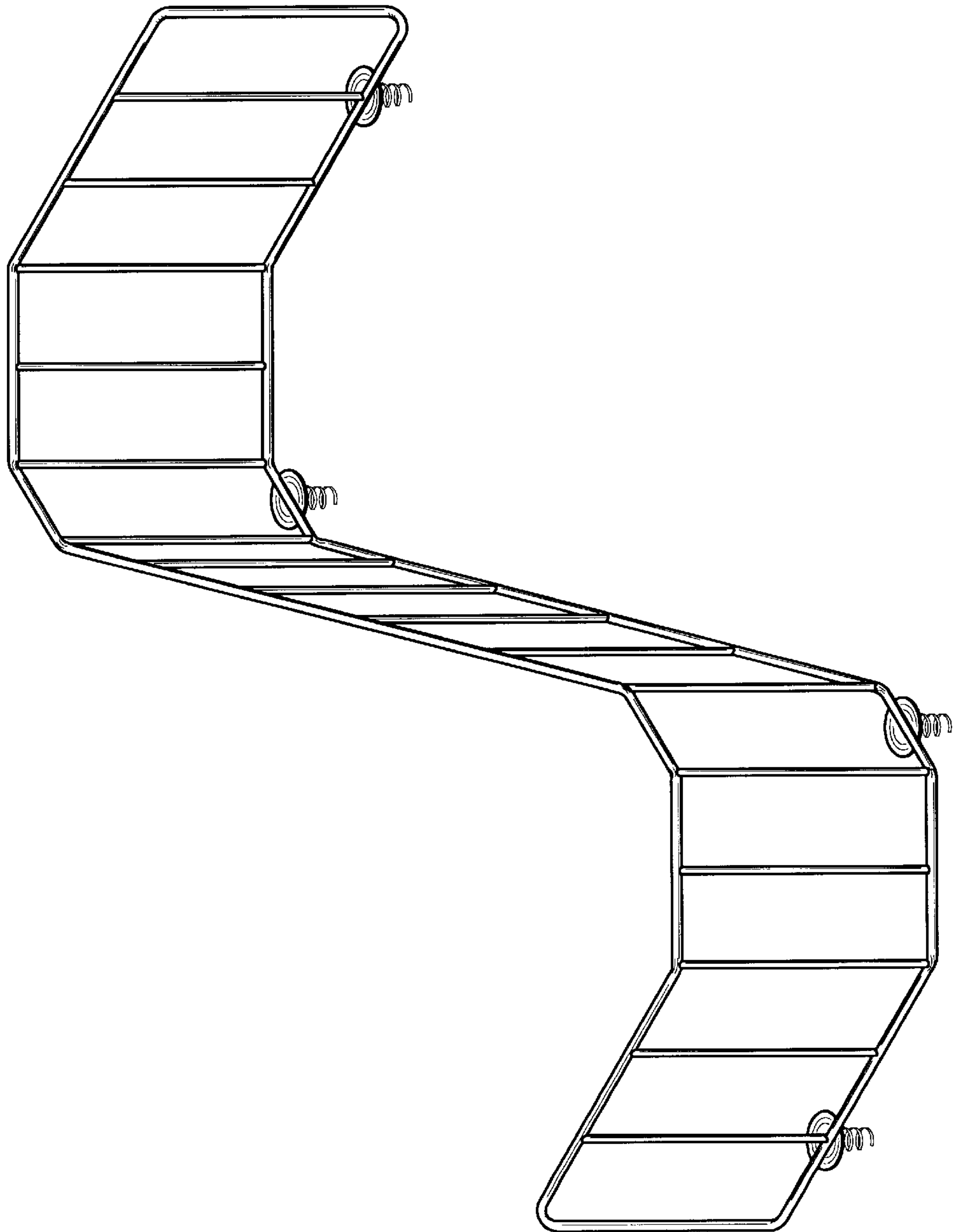

FIG. 17

FIG. 18

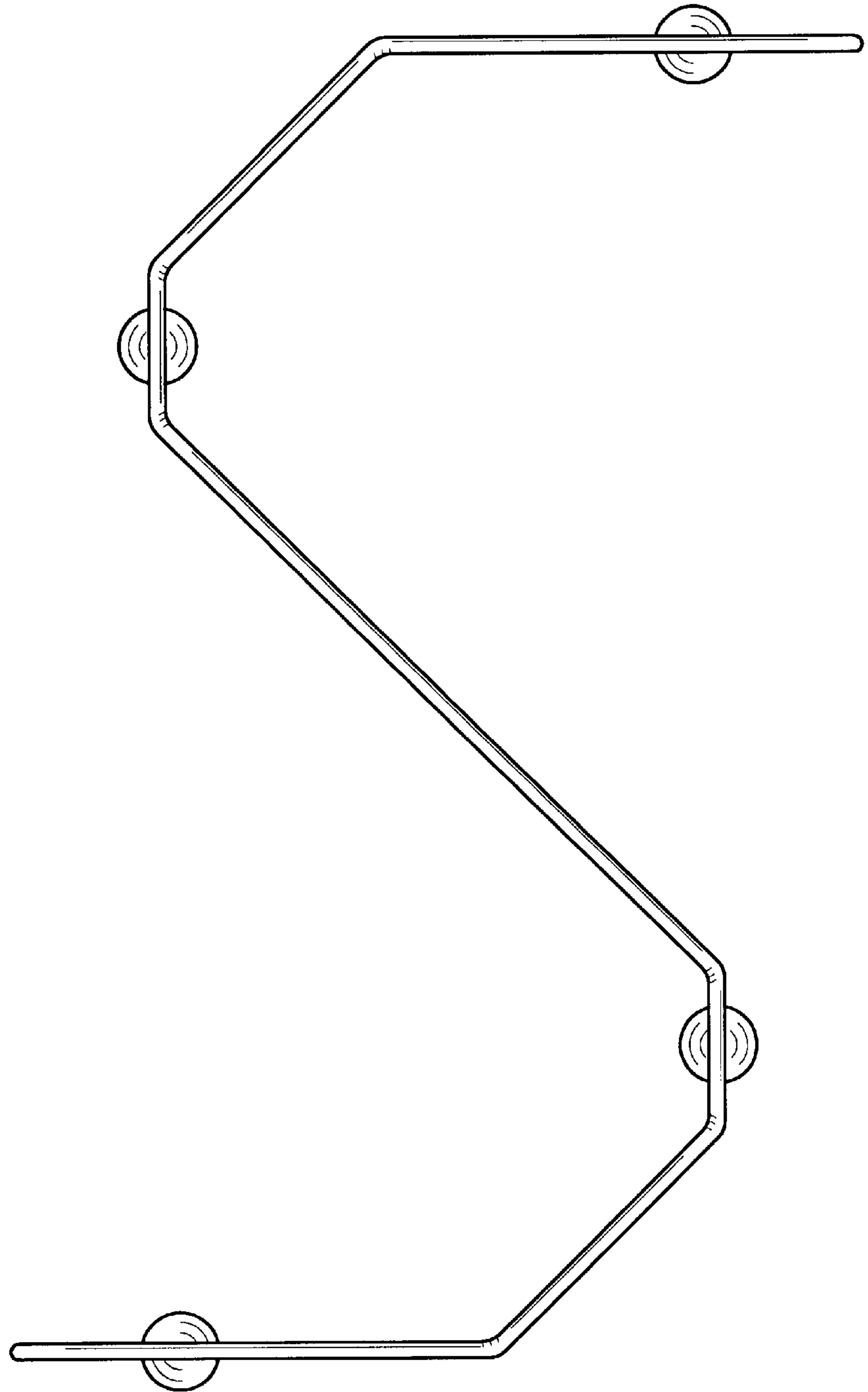

FIG. 19

