



US00D410260S

United States Patent [19] Lun

[11] Patent Number: **Des. 410,260**

[45] Date of Patent: **** May 25, 1999**

[54] TOY CAR

[75] Inventor: **Wong Chung Lun**, Kowloon, The Hong Kong Special Administrative Region of the People's Republic of China

[73] Assignee: **Fu Hong Industries, Ltd.**, Mongkok, The Hong Kong Special Administrative Region of the People's Republic of China

[**] Term: **14 Years**

[21] Appl. No.: **29/064,247**

[22] Filed: **Dec. 13, 1996**

Related U.S. Application Data

[62] Division of application No. 29/042,585, Aug. 14, 1995.

Foreign Application Priority Data

| | | | | |
|---------------|------|----------------|-------|---------|
| Jun. 30, 1995 | [GB] | United Kingdom | | 2048503 |
| Jun. 30, 1995 | [GB] | United Kingdom | | 2048504 |
| Jun. 30, 1995 | [GB] | United Kingdom | | 2048505 |

[51] LOC (6) Cl. **21-01**

[52] U.S. Cl. **D21/548**

[58] Field of Search D21/71, 73, 76, D21/78-79, 128, 134, 136, 137; D12/87, 91; 446/37, 163, 456, 462, 465, 470, 446; 280/828, 87.01

[56] References Cited

U.S. PATENT DOCUMENTS

| | | | | |
|------------|---------|---------------|-------|---------|
| D. 203,843 | 2/1966 | Campbell | | D21/78 |
| D. 215,317 | 9/1969 | Hood | | D21/78 |
| D. 227,921 | 7/1973 | Tachi | | D21/136 |
| D. 256,150 | 7/1980 | Lofton et al. | | D21/76 |
| D. 260,665 | 9/1981 | Yamashina | | D21/136 |
| D. 262,564 | 1/1982 | Yamashina | | D21/136 |
| D. 282,476 | 2/1986 | Arigaya | | D21/136 |
| D. 333,327 | 2/1993 | Plater-Zyberk | | D21/76 |
| D. 374,256 | 10/1996 | Golling | | D21/78 |

Primary Examiner—Raphael Barkai
Attorney, Agent, or Firm—Woodard, Emhardt, Naughton, Moriarty & McNett

[57] CLAIM

The ornamental design for a toy car, as shown and described.

DESCRIPTION

FIG. 1 is a front perspective view of a toy car showing my new design;
FIG. 2 is a right side elevational view thereof;
FIG. 3 is a front elevational view thereof;
FIG. 4 is a top plan view thereof;
FIG. 5 is a rear elevational view thereof; and,
FIG. 6 is a bottom plan view thereof.

1 Claim, 4 Drawing Sheets

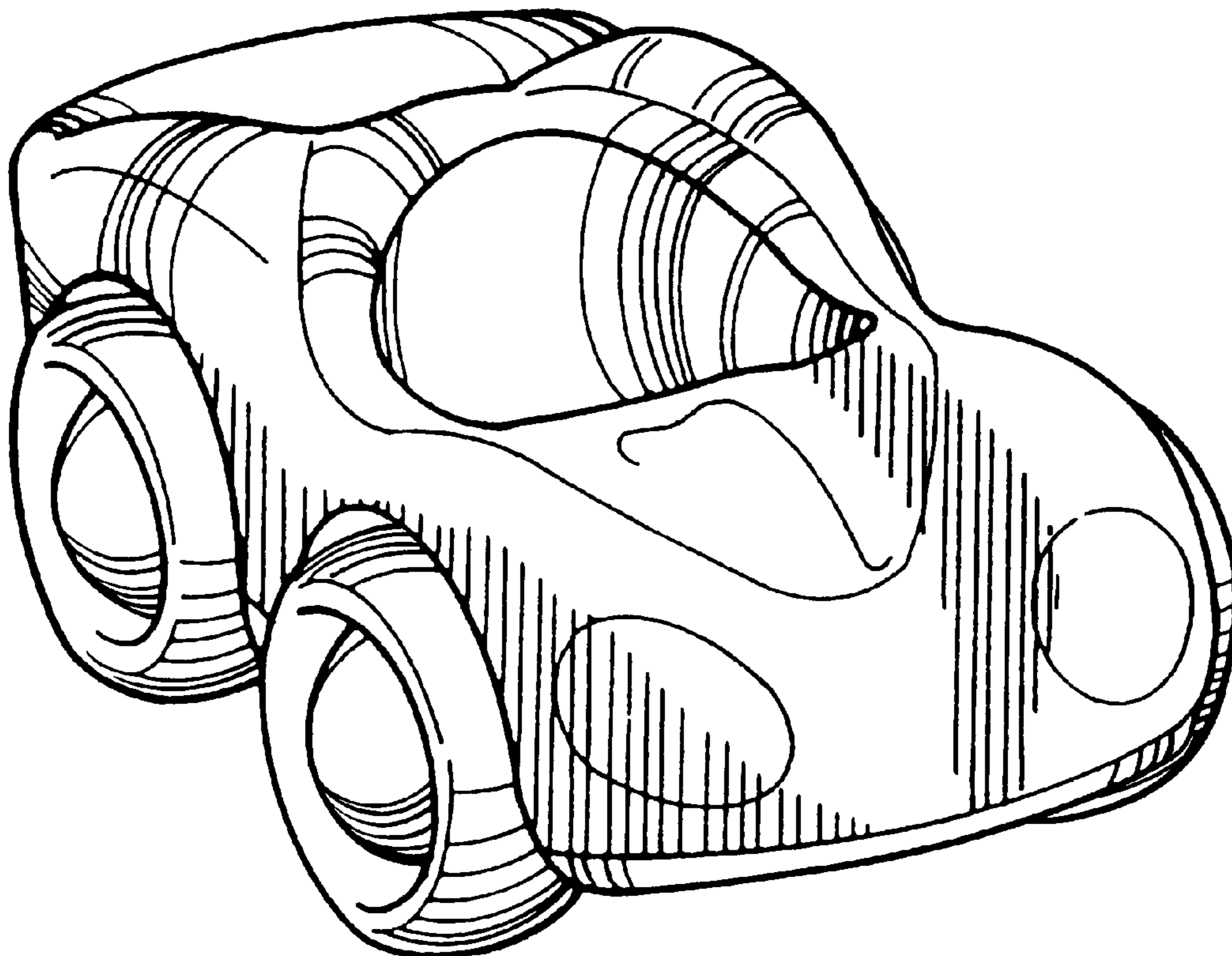

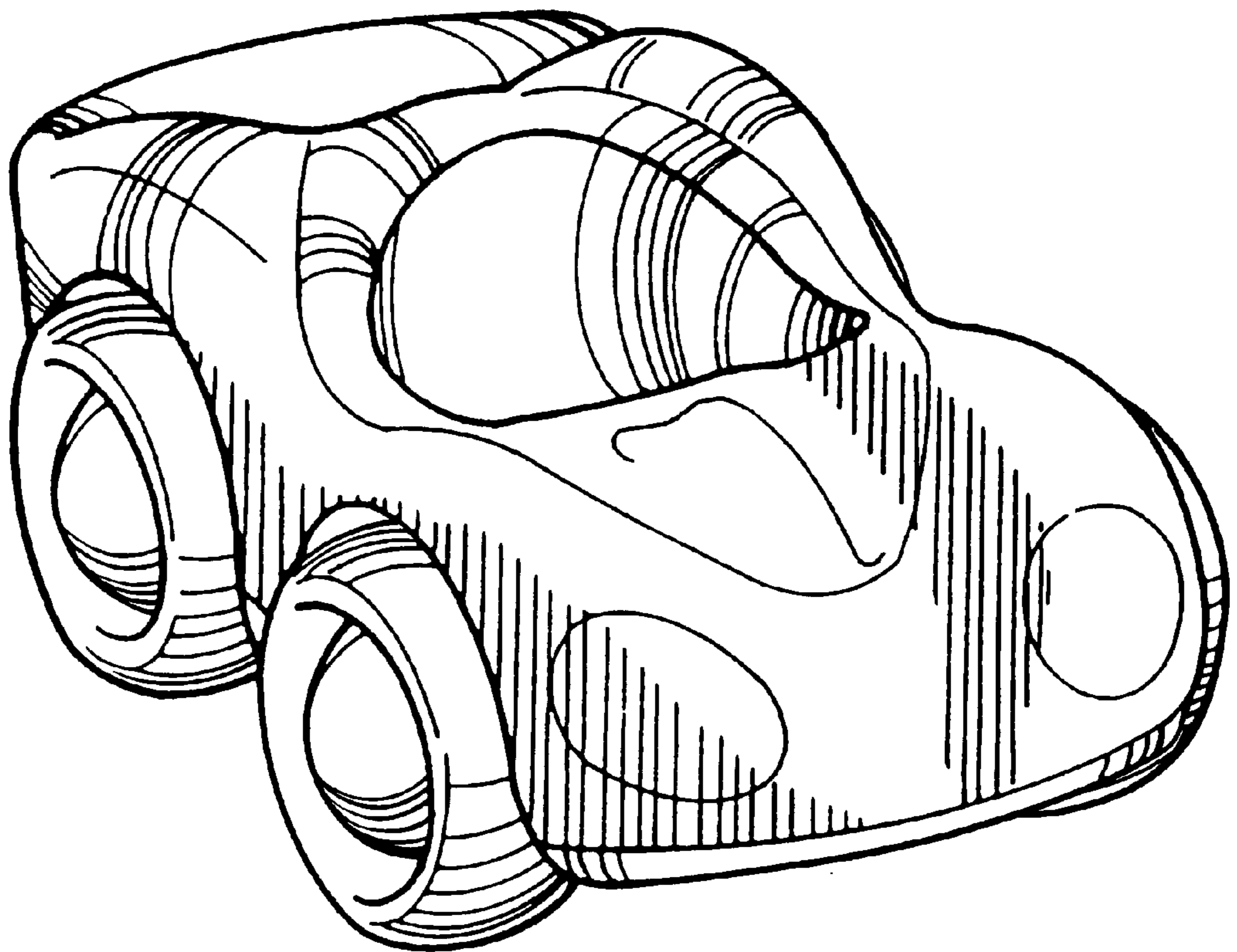

Fig. 1

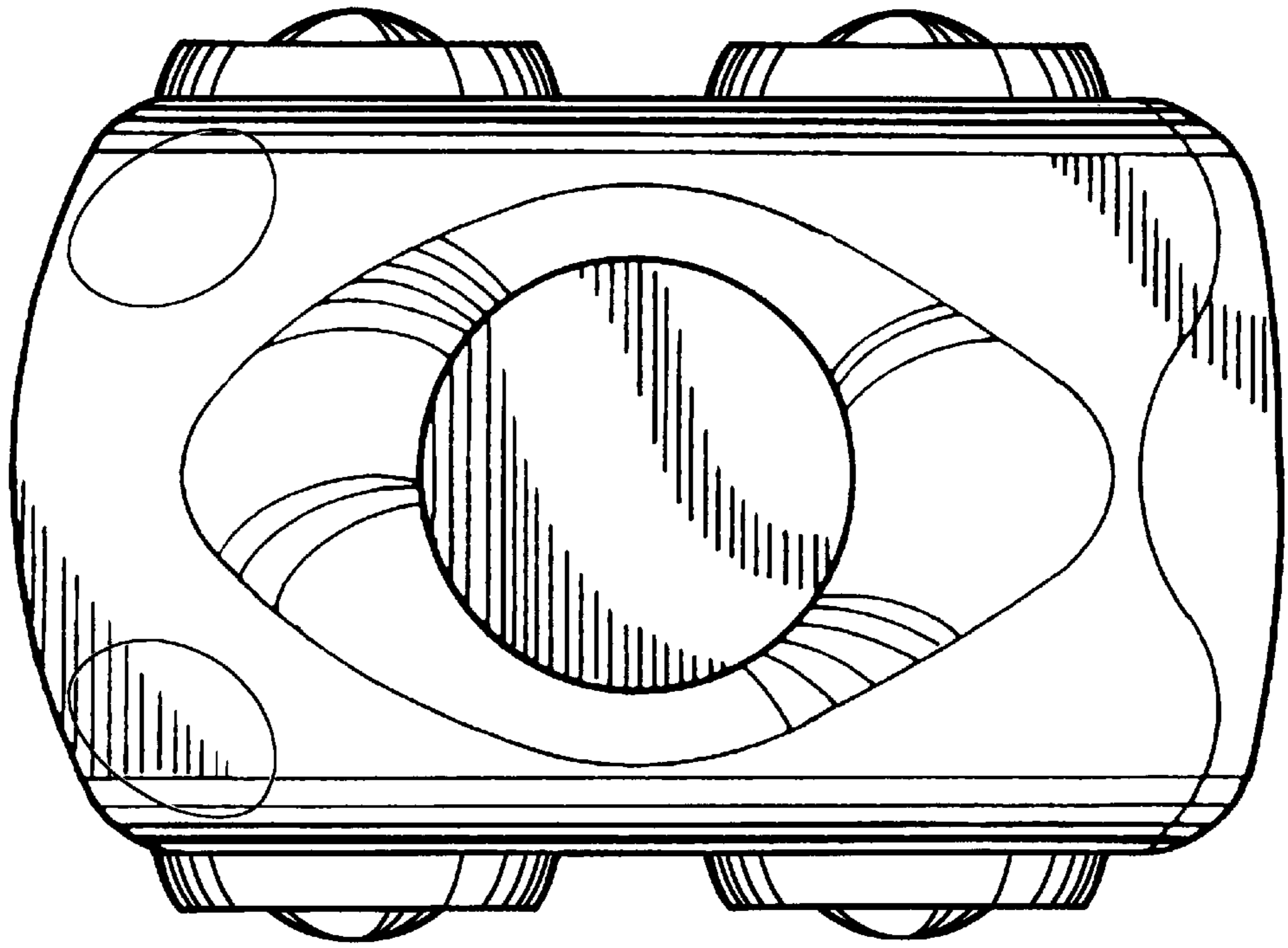

Fig. 4

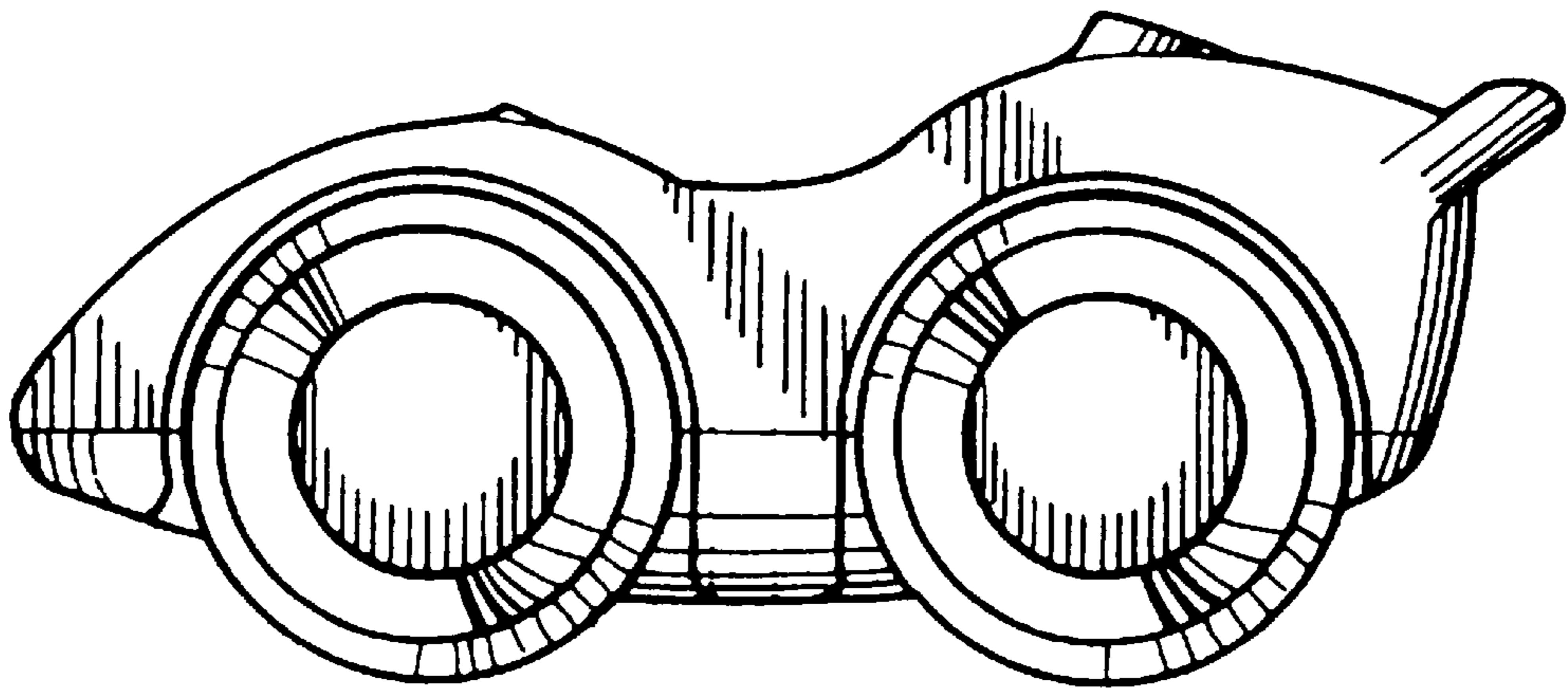

Fig. 2

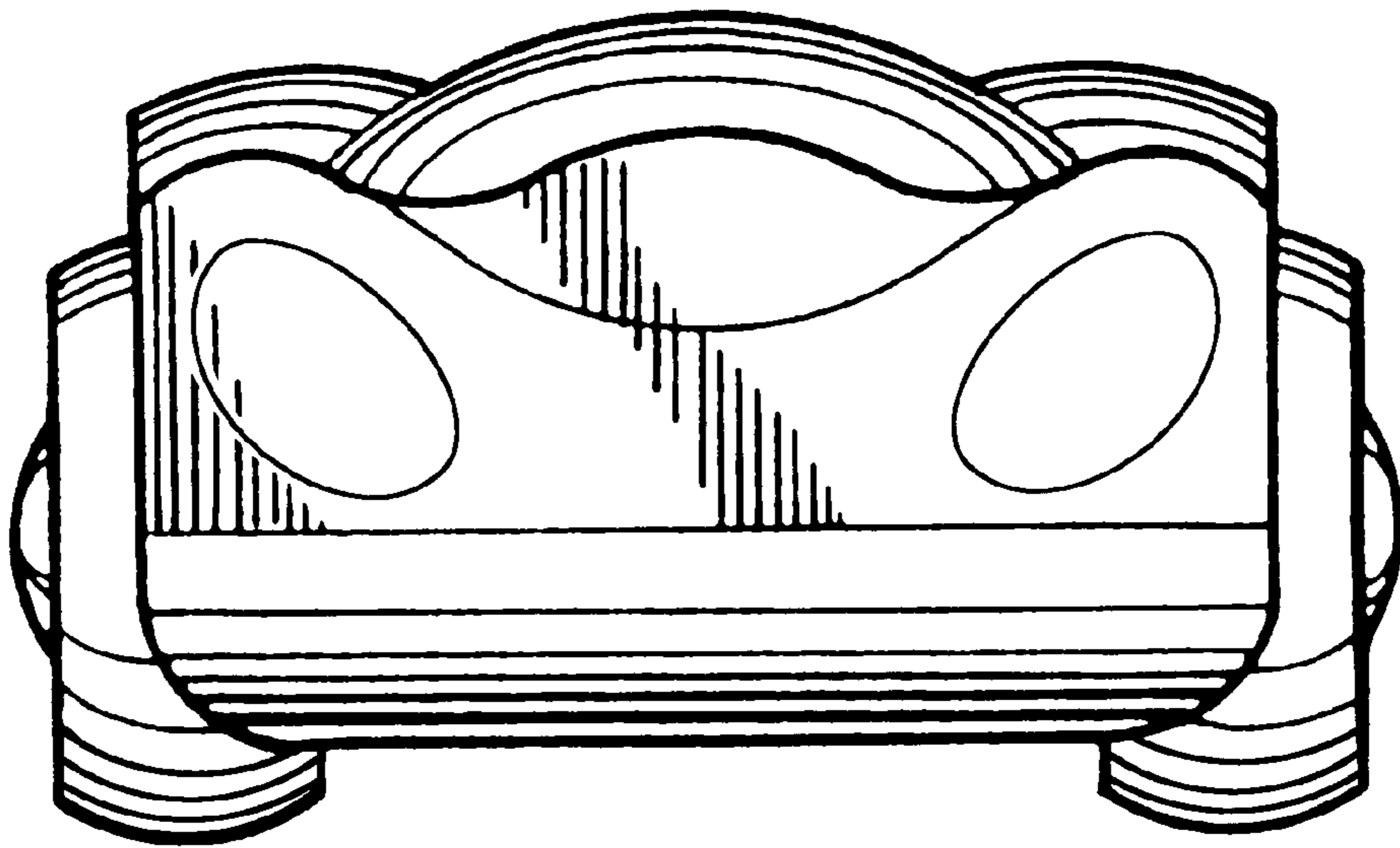

Fig. 3

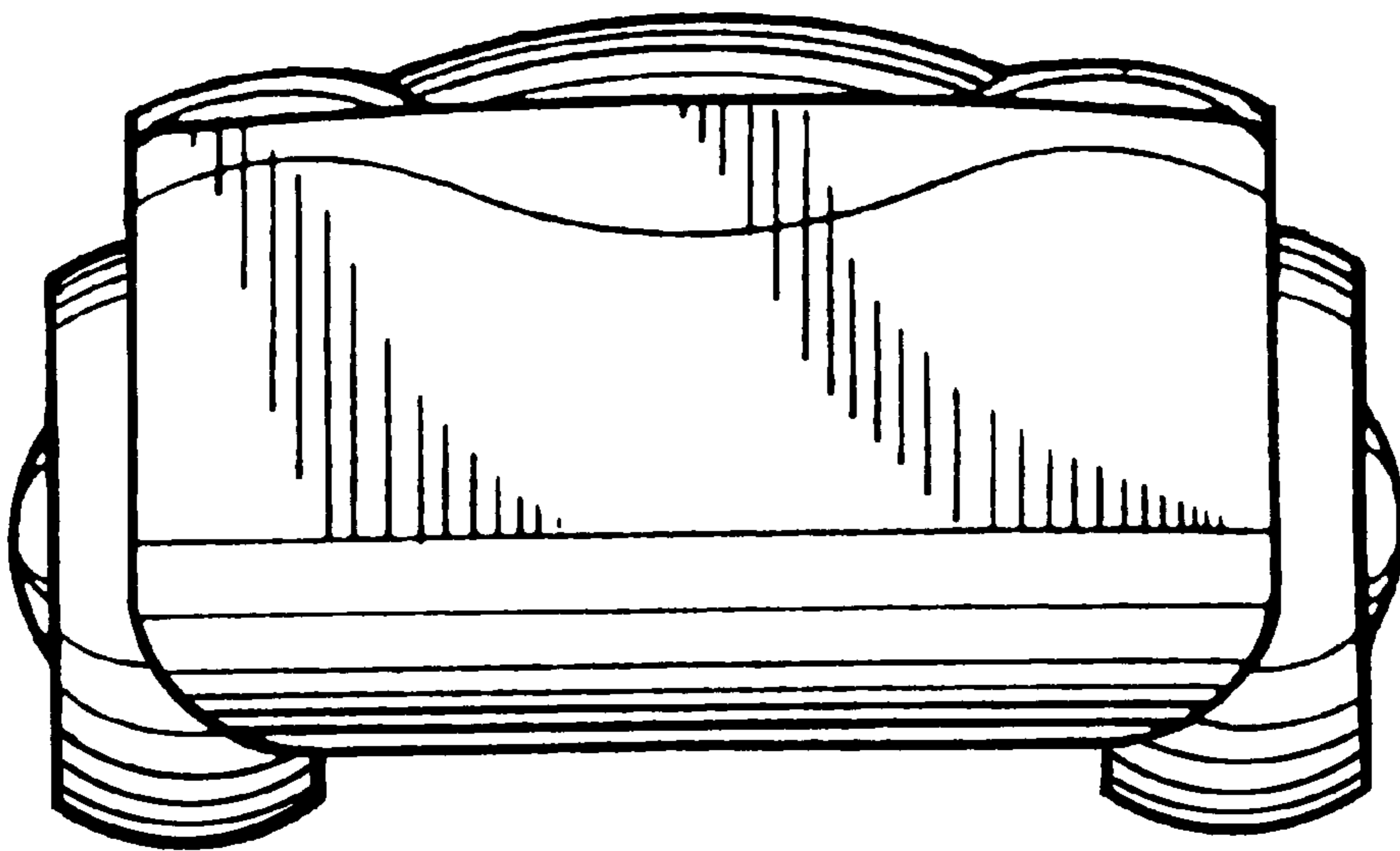

Fig. 5

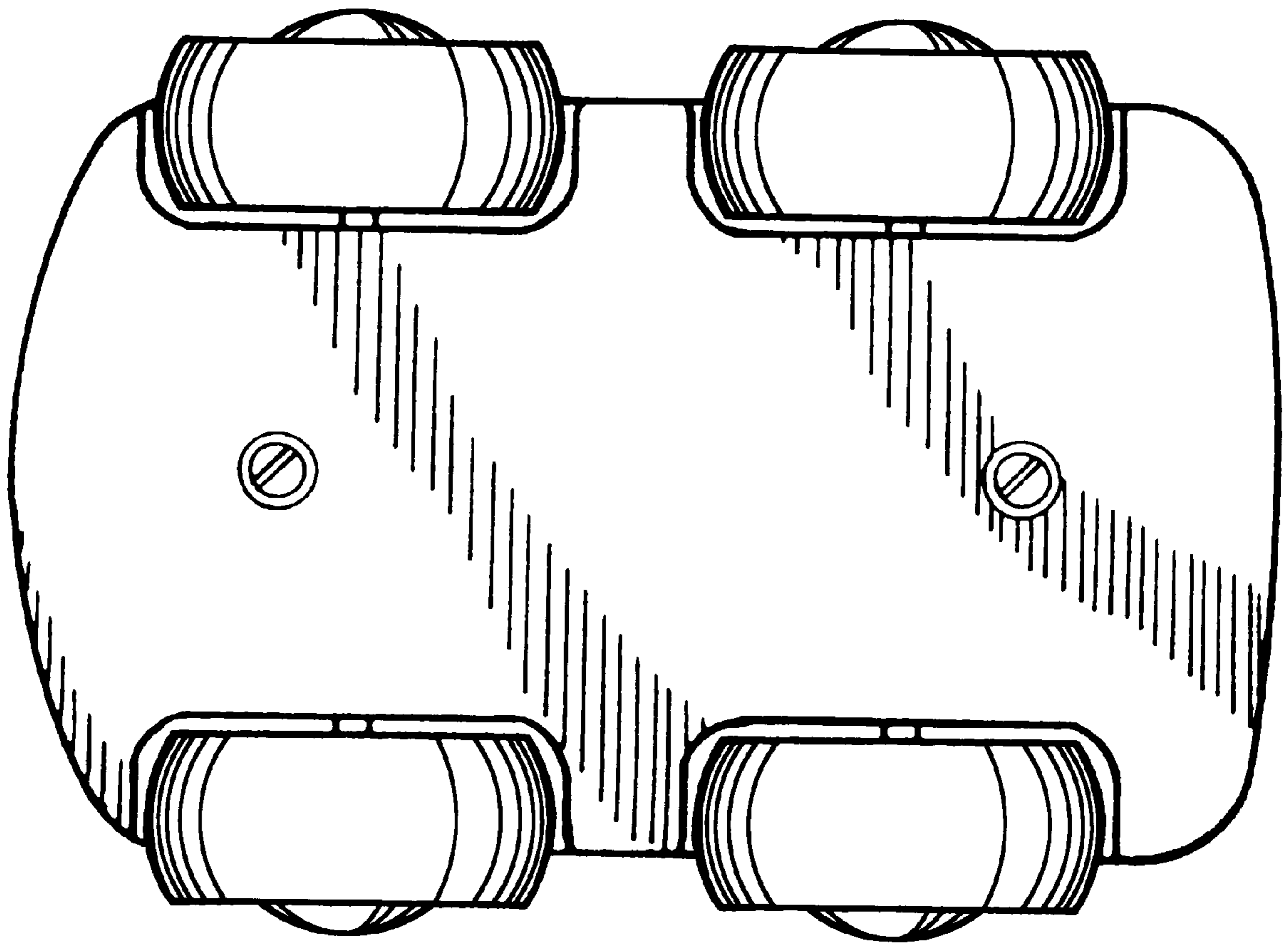

Fig. 6